



BRAGA
ILLUMINAZIONE

BRAGA
ILLUMINAZIONE

SINCE
1976

| | | | | |
|------------|-------------------------|-----------------------|-----------------------------------|-----------------------------------|
| | Bit 24V_ 444 | Puzzle_ 304 | 561/S30_ 387,388 | 2087/S30_ 369,372,373 |
| | Bon Ton_ 186 | - | 561/S40_ 384,387,388 | 2087/S40_ 371,372 |
| | - | Ray_ 250 | 561/S50_ 382,388,389 | 2087/S50_ 368,372 |
| | Candy_ 296 | Reed_ 416 | 561/S70_ 386,388 | 2087/S70_ 369,370,372 |
| | Cannula_ 418 | Rotary_ 320 | 561/S80_ 383,388 | 2087/S80_ 372 |
| <i>New</i> | Charme_ 156 | Round_ 102 | 582/A_ 432,433 | 2089/A2_ 215,219 |
| <i>New</i> | Clock_ 114 | - | 582/A-V_ 433 | 2089/A70_ 211,213 |
| | Cristalli_ 274 | Scia_ 220 | 583/S30_ 375 | 2089/A110_ 213,214 |
| | Cubo_ 426 | Sfera_ 390 | 583/S40_ 375 | 2089/PL70_ 210,213 |
| | - | Spira_ 92 | 583/S50_ 375 | 2089/PL110_ 212,213 |
| | Digit_ 262 | Syrrio_ 194 | 583/S70_ 375 | 2089/S_ 219 |
| | Dune_ 382 | - | 583/S80_ 375 | 2089/S2_ 218,219 |
| | - | Tape_ 238 | 2000_ 448,449 | 2089/T_ 216,217,219 |
| | Eclettica_ 162 | Tile_ 400 | 2010/A_ 424,425 | 2092/A2_ 315 |
| | Eclissi_ 356 | Time_ 326 | 2010/A40_ 423,425 | 2092/L_ 312,313 |
| 2 | Edison_ 434 | Traccia_ 256 | 2010/A60_ 422,425 | 2092/PL35_ 310,313 |
| | Elle_ 210 | Truciolo_ 408 | 2023_ 442,443 | 2092/PL45_ 313 |
| | - | - | 2036/A_ 426,429 | 2092/PL60_ 309,313 |
| | Flat_ 118 | Up & Down_ 332 | 2036/A1_ 428,429 | 2092/PL70_ 308,311,313 |
| | - | - | 2036/A2_ 427,429 | 2095/PL36_ 269,270 |
| | Gamma_ 288 | Virgola_ 432 | 2047/A_ 260,261 | 2095/PL50_ 266,268,269,271 |
| | Geo_ 350 | Volta_ 422 | 2047/A1_ 261 | 2095/PL60_ 269 |
| <i>New</i> | Geometric_ 010 | | 2047/A1_ 261 | 2095/PL80_ 267,269 |
| | Glass LED_ 430 | | 2051/PL36_ 281 | 2095/S50_ 272 |
| | Greka_ 368 | | 2051/PL50_ 280,281,282,283 | 2095/S80_ 272,273 |
| | - | | 2051/PL60_ 279,281 | 2096/T_ 416,417 |
| <i>New</i> | Hug_ 030 | | 2051/PL80_ 278,283 | 2100/S30_ 385 |
| | - | | 2051/PL110_ 283 | 2100/S40_ 385 |
| <i>New</i> | Jolie_ 180 | | 2051/S50_ 284,285 | 2100/S50_ 385 |
| | - | | 2051/S80_ 284,286 | 2100/S70_ 385 |
| | Keplero 24V_ 442 | | 2051/S110_ 284 | 2100/S80_ 385 |
| | - | | 2052/S50_ 287 | 2102/T_ 418,420,421 |
| | Link_ 198 | | 2052/S80_ 287 | 2103/T_ 419,421 |
| | Lithos_ 404 | | 2052/S110_ 287 | 2106/PL45_ 317,319 |
| | Loop_ 046 | | 2052/PL36_ 277 | 2106/PL60_ 318,319 |
| | - | | 2052/PL50_ 274,275,277 | 2106/PL80_ 316,319 |
| <i>New</i> | Nets_ 018 | | 2052/PL60_ 277 | 2107/A1_ 331 |
| | Nuvola_ 308 | | 2052/PL80_ 283 | 2107/A2_ 327,328,331 |
| | - | | 2052/PL110_ 276,283 | 2107/L_ 330,331 |
| | Orione_ 448 | | 2053/AP-F_ 257,258 | 2107/PL40_ 331 |
| | - | | 2053/AP-R_ 257,259 | 2107/PL50_ 329,331 |
| | Pattern_ 266 | | 2053/T1A_ 256,257 | 2107/PL80_ 326,331 |
| | Pianeta_ 316 | | 2053/T2B19_ 256,257 | 2108/A_ 394,395 |
| | | | 2068/A3_ 263,265 | 2108/L_ 391,395 |
| | | | 2068/PL80_ 265 | 2108/N_ 398 |
| | | | 2068/PL125_ 264,265 | 2108/PL3_ 392,395 |
| | | | 2068/S_ 262,265 | 2108/PL4_ 390,395 |
| | | | 2075/1-37_ 444,445 | 2108/R6_ 398 |
| | | | 2075/1-75_ 445,447 | 2108/R12_ 398 |
| | | | 2075/2-37_ 444,445 | 2108/S1_ 393,398 |
| | | | 2075/2-75_ 445,447 | 2108/S4_ 396,397 |
| | | | 2080/A_ 294,295 | 2108/SM_ 398,399 |
| | | | 2080/A2_ 292,293 | 2111/PL50_ 304,305,306,307 |
| | | | 2080/PL50_ 290,293 | 2111/PL60_ 304,305,306,307 |
| | | | 2080/PL65_ 291,293 | 2112/T_ 404,405,406,407 |
| | | | 2080/PL90_ 289,293 | |
| | | | 2080/S_ 288,293 | 2113/N_ 441 |
| | | | 2081/PL20_ 431 | 2113/R6_ 441 |
| | | | 2081/PL30_ 431 | 2113/R12_ 441 |
| | | | 2081/PL40_ 430,431 | 2113/S1_ 435,440 |
| | | | 2081/PL50_ 431 | 2113/SM_ 434,436,437,441 |
| | | | 2081/PL60_ 431 | 2113/T_ 438,439 |
| | | | 2083/A_ 411,413 | |
| | | | 2083/L_ 412,413 | 2116/A_ 324,325 |
| | | | 2083/T_ 408,409,410,413 | 2116/A2_ 325 |
| | | | 2084/L70_ 414,415 | 2116/PL35_ 322,323 |
| | | | 2084/T_ 413 | 2116/PL50_ 321,323 |
| | | | 2087/A_ 380,381 | 2116/PL60_ 320,323 |
| | | | 2087/N_ 378,379 | 2118/A1_ 300,302,303 |
| | | | 2087/R6_ 376,379 | 2118/L_ 303 |
| | | | 2087/R12_ 379 | 2118/PL30_ 297,299,301 |
| | | | 2087/S1-9_ 374,376,378,379 | 2118/PL40_ 299 |
| | | | 2087/S16-9_ 379 | 2118/PL55_ 298,299 |

2118/PL70_296,299
2121/S1_402,403
2121/S2_400,403
2121/T_401,403
2123/PL40_354,355
2123/PL50_355
2123/PL60_351,355
2123/S40_352
2123/S50_352,353
2123/S60_350,352
2125/A2_252,253,254
2125/L_254,255
2125/PL70_250,254
2125/PL90_251,254
2127/A1_231,235
2127/A2_234,235
2127/L_230,233
2127/PL_221,223
2127/PL1_227,236
2127/PL2_228,229,236
2127/PL3_232,236,237
2127/PL50_224,233
2127/PL60_225,226,233
2127/PL110-2_236
2127/S_222,223
2127/S3_220,223
2128/S60-40-1_71
2128/S60-40-2_72,73
2128/S75-50-1_70,71
2128/S75-50-2_72
2128/S90-60-1_71
2128/S90-60-2_72
2129/A45_91
2129/A60_90,91
2129/R1-30_32,48
2129/R1-60_34,36,50,53,56
2129/R1-100_35,38,53,54,59,
61
2129/R1-150_39,54,61
2129/R2_40,68
2129/R3_40,68
2129/PL2_80,81
2129/PL60_82, 83,84,85
2129/PL75_84,85
2129/R220-0-150_44,76,98
2129/R220-30_48
2129/R220-60_50,53,56
2129/R220-100_53,54,59,61
2129/R260-150_54,61
2129/R260-200_62
2129/R350_67
2129/R440_67
2129/RO-200_39,62
2129/R-S-G_65
2129/S1_86
2129/S2_86,87
2129/S40-1_48
2129/S40-2_56
2129/S50_47,51,52,66,69,70
2129/S50-1_50
2129/S50-2_49,59
2129/S60-1_50
2129/S60-2_59
2129/S75_46,47,51,52,58,60,
66,69,70
2129/S75-1_53
2129/S75-2_61
2129/S90-1_53
2129/S90-2_61,63
2129/S120_46
2129/S120-1_54
2129/S120-2_62
2129/S150_47,66

2129/S150-1_54
2129/S150-2_62
2129/T_88,89
2129/TR40_79
2129/TR50_78,79
2129/TR60_79
2129/TR75_78,79
2129/TR90_49,76
2129/TR120_76,77
2129/TR150_76
2130/PL60_100,101
2130/PL75_101
2130/S60_92,93,94,95,97
2130/S75_95
2130/S90_92,93,96
2130/TR60_98
2130/TR75_98
2130/TR90_98,99
2130/TR110_98
2130/S110_92,96
2131/S60_102,103
2131/S60-1_104
2131/S60-2_104
2131/S80_102
2131/S80-1_104
2131/S80-2_104
2131/TR60_109
2131/TR80_108,109
2132/PL125_112,113
2132/S125_106
2132/S125-1_107
2132/S125-2_107
2132/TR125_110,111
2133/A1_246,249
2133/A2_244,247,249
2133/L_249
2133/N_243
2133/PL3_245,249
2133/PLS-5_239
2133/PLS-7_238,239
2133/PLS-11_239
2133/R_43,44,76,78,79,98,
109,111,241,242,243
2133/S1_243
2133/SM_240,241,242,243
2134/S50-2_75
2134/S60-2_75
2134/S75_74
2134/S75-2_75
2134/S90-2_75
2135/S_196,197
2135/S2_197
2136/A25_150,151
2136/L_154,155
2136/PL50_146
2136/PL60_146
2136/PL75_146
2136/PL90_146,147
2136/R1-60_132,135,201
2136/R1-100_132,135,143,201
2136/S65_136
2136/S65-1_141
2136/S65-2_141
2136/S80-1_141
2136/S80-2_141
2136/S110_137
2136/S110-1_138
2136/S110-2_138
2136/T_152,153
2136/TR110_142,143
2137/AP20_148,151
2137/AP45_151
2137/AP54_149,151

2137/S55_118
2137/S55-1_122
2137/S55-2_122
2137/S75_118
2137/S75-1_122
2137/S75-2_122
2137/S90_118,123
2137/S90-1_124
2137/S90-2_124
2137/S120_118
2137/S120-1_124
2137/S120-2_124
2137/S140_129
2137/S140-1_128
2137/S140-2_128
2137/TR55_134,135
2137/TR75_135
2137/TR90_135
2137/TR120_135
2138/PL-79_131
2138/PL-109_131
2138/PL-129_130,131
2138/PL-141_131
2138/S79-1_125
2138/S79-2_125
2138/S109_126
2138/S109-1_125
2138/S109-2_125
2138/S129-1_127
2138/S129-2_127
2138/S141-1_128
2138/S141-2_128
2138/TR-79_132
2138/TR-109_132
2138/TR-129_132,133
2138/TR-141_132
2139/A70_204,205
2139/A110_204,205
2139/A170_204,205
2139/A245_204,205
2139/CAB_201,203
2139/P-S140_202,203
2139/P-S200_202,203,206
2139/R140_201
2139/S70_199,200
2139/S110_199,200
2139/S170_199,200
2139/S245_199
2140/A25_358,359
2140/PL40_359
2140/PL55_357,359
2140/PL75_359
2140/PL85_359
2140/PL100_356,359
2140/S25_360
2140/S40_360
2140/S55_360
2140/S75_363
2140/S85_362,363
2140/S100_361,363
2141/70_209
2141/110_209
2141/170_209
2141/R440-150_209
2143/S_194,195
2143/S2_195
2144/S1_163,164,165,167
2144/S2_163,164,165,167
2144/S3_163,164,165,167
2144/S4_163,164,165,167
2145/PL50/3_160,176,185,191
2145/PL80/5_160,176,
185,191,339,450

2145PL80/7_160,164,176,180,
189,185,191,338,339,450
2145/PL110/11_160,176,185,
191,339,450
2146/A_160,176,178,179,185,
190,191,339,346,450
2146/N_160,176,185,191,193,
339,450
2146R1_157,160,170,171,172,
176,185,191,192,333,334,
337,339,343,450
2146/R6_160,169,176,185,
191,193,339,450
2146/R12_160,176,185,191,
339,450
2146/R35_16,25,26,32,34,35,
36,38,39,48,50,52,54,56,59,
61,62,67,71,72,96,160,176,
185,191,209,219,240,243,
336,339,379,398,403,450
2146/PL3_160,176,185,186,
191,339,450
2146/PL4_160,165,173,176,
181, 185,191,335,339,450
2146/PL5_156,160,176,185,
187,191,339,450
2146/PL7_160,176,185,191,
339,450
2146/PL11_158,160,163,176,
185,191,339,450
2147/50_160,176,185,191,339
450
2147/100_160,176,185,191,
339,450
2147/150_160,176,177,182,18
5,191,332,339,450
2147/200_160,176,185,191,
339,450
2147/250_160,176,185,191,
339,450
2149/A25_365,367
2149/PL40_365
2149/PL55_364,365
2149/S25_366
2149/S40_366
2149/S55_366
2150/1_332,335,336,337,338
340,342,344,345,346,347,
349
2150/2_332,338,342,345,
347,349
2150/3_332,333,335,336,
338,340,342,343,344,345,
346,347,349
2150/4_332,333,334,342,
345,347,349
2150/5_348,349
2150/A1_340
2150/A2_340,341
2150/PL_344,345
2150/PL3_344,345
2150/S_334,335,337,338,
342,346
2150/S2_332,333,335,336,
338,342,343
2150/T1_348,349
2151/S1_168,169,178
2151/S2_168,169,173,179
2151/S3_168,169
2151/S4_168,169,170
2151/S5_168,171
2151/T_174

2153/1_186,187,188,
190,192
2153/2_187,188,192
2154/PL70_13
2154/PL90_13
2154/PL110_10,13
2154/PL130_12,13
2154/TR70_11,15
2154/TR90_15
2154/TR110_14,15
2154/TR130_15
2154/S130_17
2154/S130-1_16
2154/S130-2_16
2155/PL95_18,20
2155/A1_20
2155/A2_20,21
2155/PL115_20
2155/PL145_19,20
2155/S_26
2155/S2_26,27
2155/S-G_26
2155/S2-G_26
2155/S145_24
2155/S145-1_25
2155/S145-2_25
2155/TR66_28,29
2155/TR95_23
2155/TR108_28,29
2155/TR115_22,23
2155/TR134_28,29
2155/TR145_23
2155/TR159_29
2156/S_156,158,159
2156/S2_157,158,159
2157/S_180,181,182,183
2158/S2_168,172,173
2158/T_175
2159/S40-1_31,32
2159/S40-2_36,37
2159/S50_32,40
2159/S50-2_36
2159/S60-1_34,40
2159/S60-2_38
2159/S75-1_34
2159/S75-2_38
2159/S90_30
2159/S90-1_34,40
2159/S90-2_38
2159/S120-1_35
2159/S120-2_33,39,40
2159/S150-1_35
2159/S150-2_39
2159/TR40_43
2159/TR50_42,43
2159/TR60_42,43,45
2159/TR75_43
2159/TR90_42,44
2159/TR120_44
2159/TR150_44
2160/PL50-1_117
2160/PL50-2_117
2160/PL60-1_115,116,117
2160/PL60-2_117
2160/PL80-1_117
2160/PL80-2_114,117

LAMPADA
DA PARETE

WALL LAMP

A

LAMPADA
DA PLAFONE

CEILING LAMP

PL

LAMPADA
DA SOSPENSIONE

SUSPENSION

S

LAMPADA
DA TERRA

FLOOR LAMP

T

LAMPADA
DA TAVOLO

TABLE LAMP

L

LAMPADA
DA INCASSO

RECESSED SPOT

TESATE

WIRE SYSTEM

New GEOMETRIC
2154
pag. 010

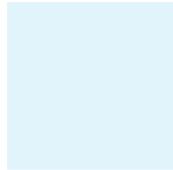
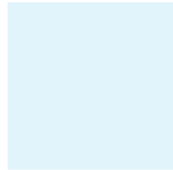
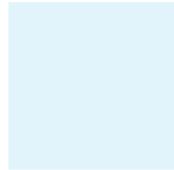
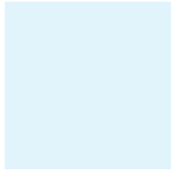

New NETS
2155
pag. 018

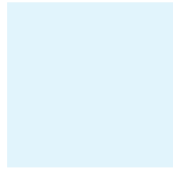
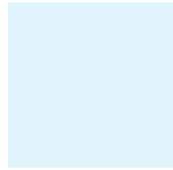
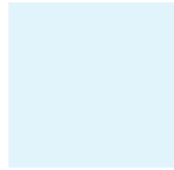

New HUG
2159
pag. 030

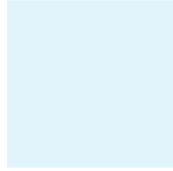
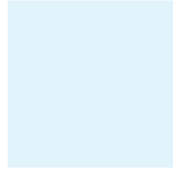
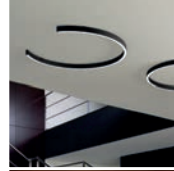

LOOP
2128 - 2129 - 2134
pag. 046

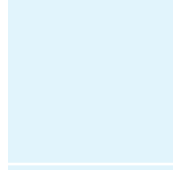
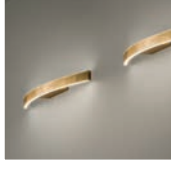

SPIRA
2130
pag. 092

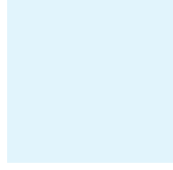
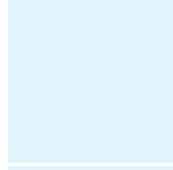
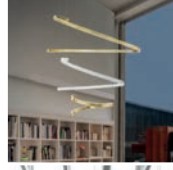
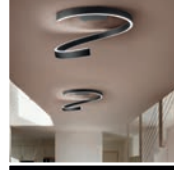
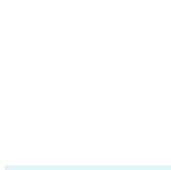

ROUND
2131 - 2132
pag. 102

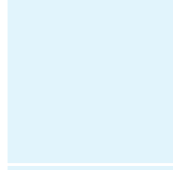
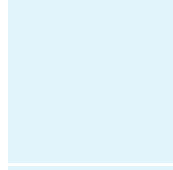
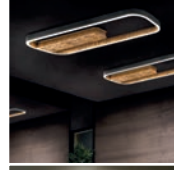
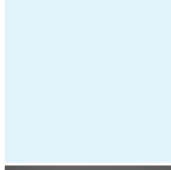

New CLOCK
2160
pag. 114

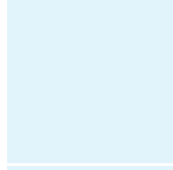
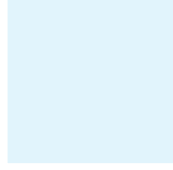
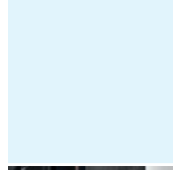
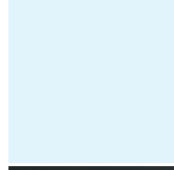
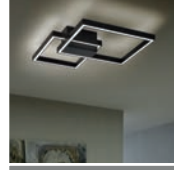
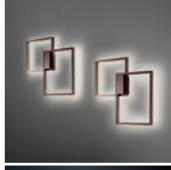

FLAT
2136 - 2137 - 2138
pag. 118

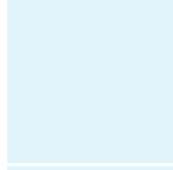
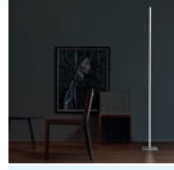
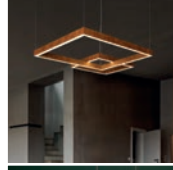
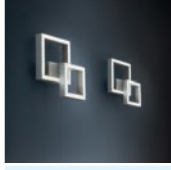

New CHARME
2156
pag. 156

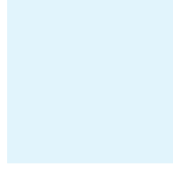
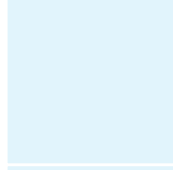
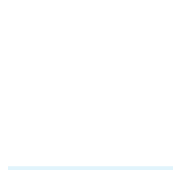
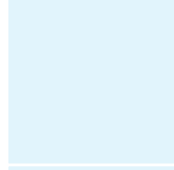
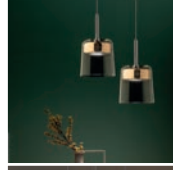
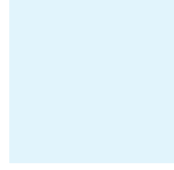
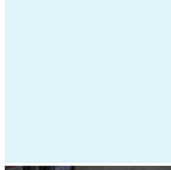



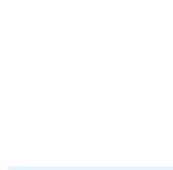
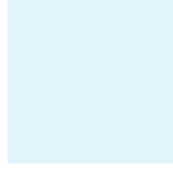
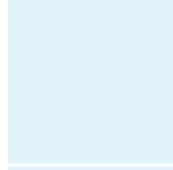
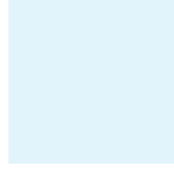
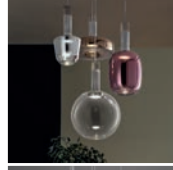
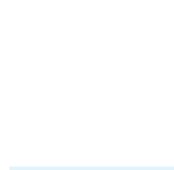



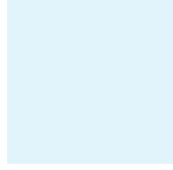
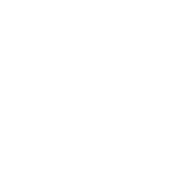
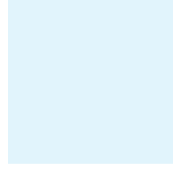
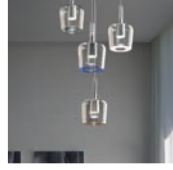
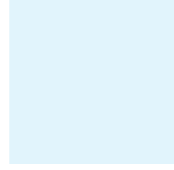





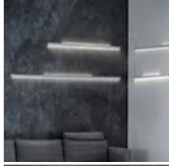

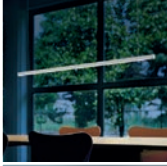

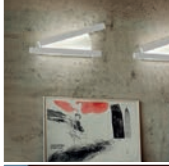
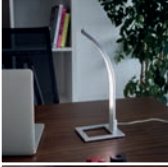
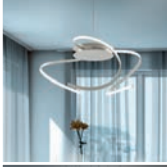

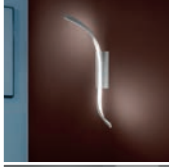

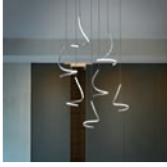





ECLETTICA
2144 - 2151 - 2158
pag. 162

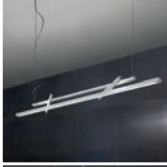

New JOLIE
2157
pag. 180



| TESATE | LAMPADA DA INCASSO | LAMPADA DA TAVOLO | LAMPADA DA TERRA | LAMPADA DA SOSPENSIONE | LAMPADA DA PLAFONE | LAMPADA DA PARETE |
|-------------|--------------------|---|---|--|---|---|
| WIRE SYSTEM | RECESSED SPOT | TABLE LAMP | FLOOR LAMP | SUSPENSION | CEILING LAMP | WALL LAMP |
| | | L | T | S | PL | A |
| | | | |  | |  |
| | | | |  | | |
| | | | |  | |  |
| | | |  |  |  |  |
| | |  | |  |  |  |
| | |  | |  |  |  |
| | |  | | |  |  |
| | | |  | | |  |
| | | | |  |  |  |
| | | | |  |  | |
| | | | |  |  | |

BON TON
2153
pag. 186

SYRIO
2135 - 2143
pag. 194

LINK
2139 - 2141
pag. 198

ELLE
2089
pag. 210

SCIA
2127
pag. 220

TAPE
2133
pag. 238

RAY
2125
pag. 250

TRACCIA
2053 - 2047
pag. 256

DIGIT
2068
pag. 262

PATTERN
2095
pag. 266

CRISTALLI
2051 - 2052
pag. 274

LAMPADA
DA PARETE
WALL LAMP

LAMPADA
DA PLAFONE
CEILING LAMP

LAMPADA
DA SOSPENSIONE
SUSPENSION

LAMPADA
DA TERRA
FLOOR LAMP

LAMPADA
DA TAVOLO
TABLE LAMP

LAMPADA
DA INCASSO
RECESSED SPOT

TESATE
WIRE SYSTEM

A

PL

S

T

L

**GAMMA
2080**
pag. 288

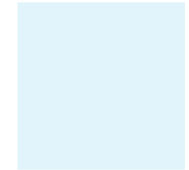
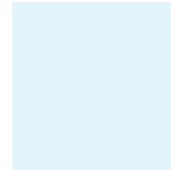
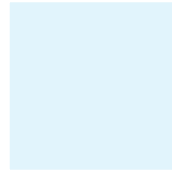

**CANDY
2118**
pag. 296

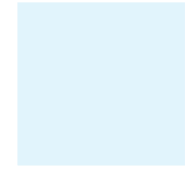
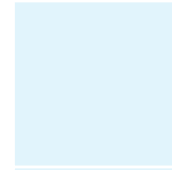
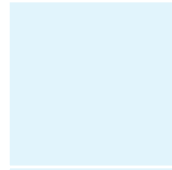
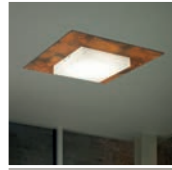
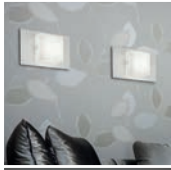

**PUZZLE
2111**
pag. 304

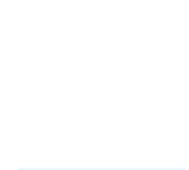
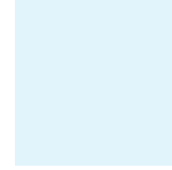
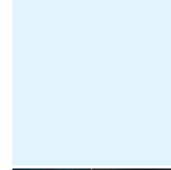
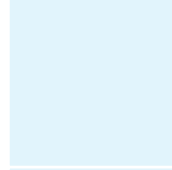
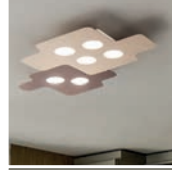

**NUVOLA
2092**
pag. 308

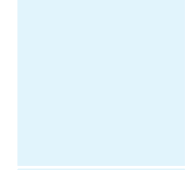
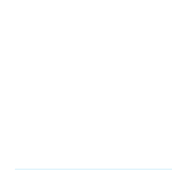
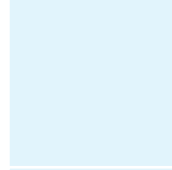
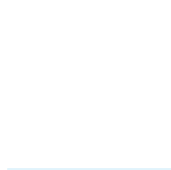
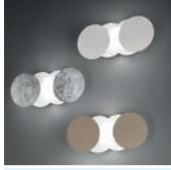

**PIANETA
2106**
pag. 316

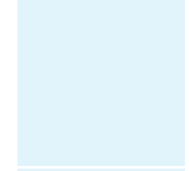
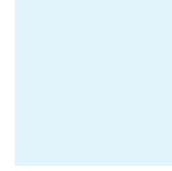
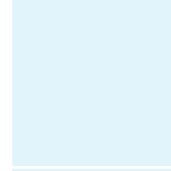
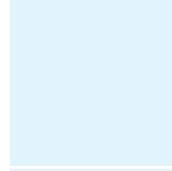
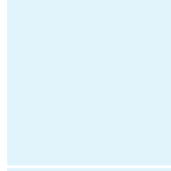
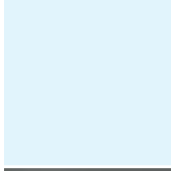

**ROTARY
2116**
pag. 320

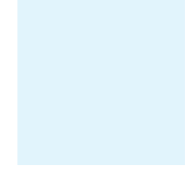
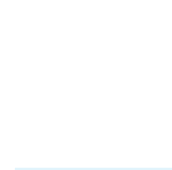
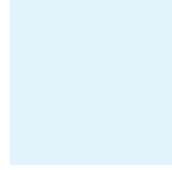
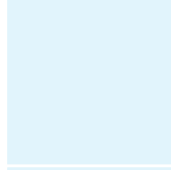

**TIME
2107**
pag. 326

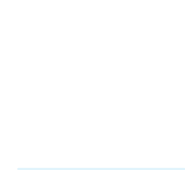
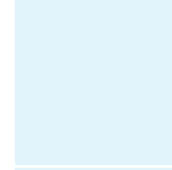
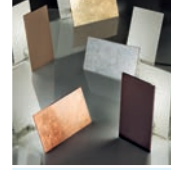
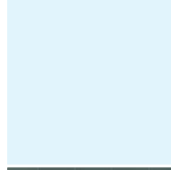

**UP & DOWN
2150**
pag. 332

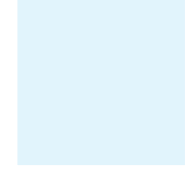
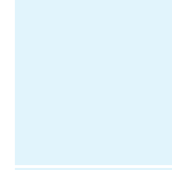
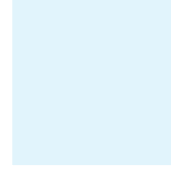
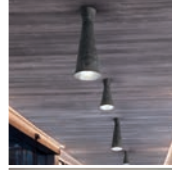
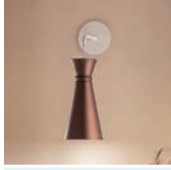

**GEO
2123**
pag. 350

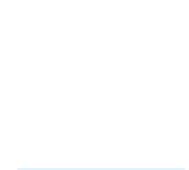
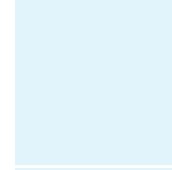
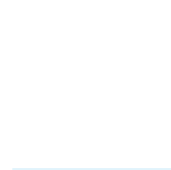
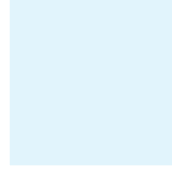
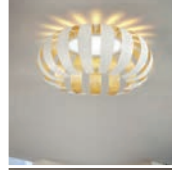



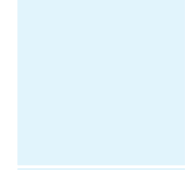
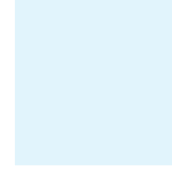
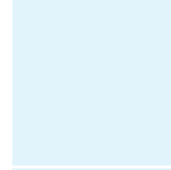
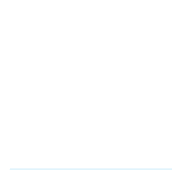
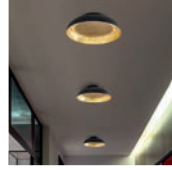
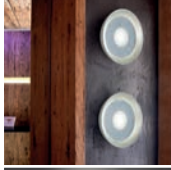



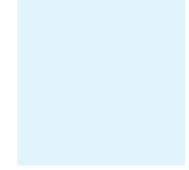
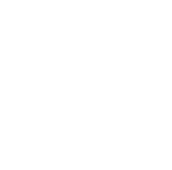
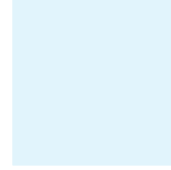
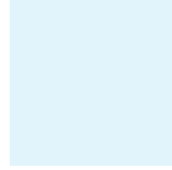
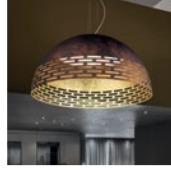
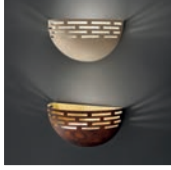





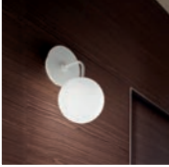



**ECLISSI
2140 - 2149**
pag. 356

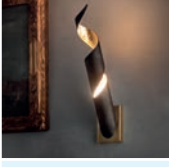

**GREKA
2087 - 583**
pag. 368

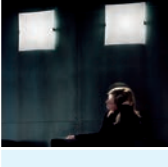

| TESATE | LAMPADA DA INCASSO | LAMPADA DA TAVOLO | LAMPADA DA TERRA | LAMPADA DA SOSPENSIONE | LAMPADA DA PLAFONE | LAMPADA DA PARETE |
|-------------|--------------------|--|---|--|---|---|
| WIRE SYSTEM | RECESSED SPOT | TABLE LAMP | FLOOR LAMP | SUSPENSION | CEILING LAMP | WALL LAMP |
| | | L | T | S | PL | A |
| | | | |  | | |
| | |  | |  |  |  |
| | | |  |  | | |
| | | |  | | | |
| | |  |  | | |  |
| | | |  | | | |
| | | |  | | | |
| | | | | | |  |
| | | | | | |  |
| | | | | |  |  |
| | | | | | |  |

DUNE
561 - 2100
pag. 382

SFERA
2108
pag. 390

TILE
2121
pag. 400

LITHOS
2112
pag. 404

TRUCIOLO
2083 - 2084
pag. 408

REED
2096
pag. 416

CANNULA
2102 - 2103
pag. 418

VOLTA
2010
pag. 422

CUBO
2036
pag. 426

GLASS LED
2081
pag. 430

VIRGOLA
582
pag. 432

LAMPADA
DA PARETE

WALL LAMP

A

LAMPADA
DA PLAFONE

CEILING LAMP

PL

LAMPADA
DA SOSPENSIONE

SUSPENSION

S

LAMPADA
DA TERRA

FLOOR LAMP

T

LAMPADA
DA TAVOLO

TABLE LAMP

L

LAMPADA
DA INCASSO

RECESSED SPOT

TESATE

WIRE SYSTEM

EDISON
2113
pag. 434

KEPLERO 24V
2023
pag. 442

BIT 24V
2075
pag. 444

ORIONE
2000
pag. 448



BRAGA
ILLUMINAZIONE

Geometric

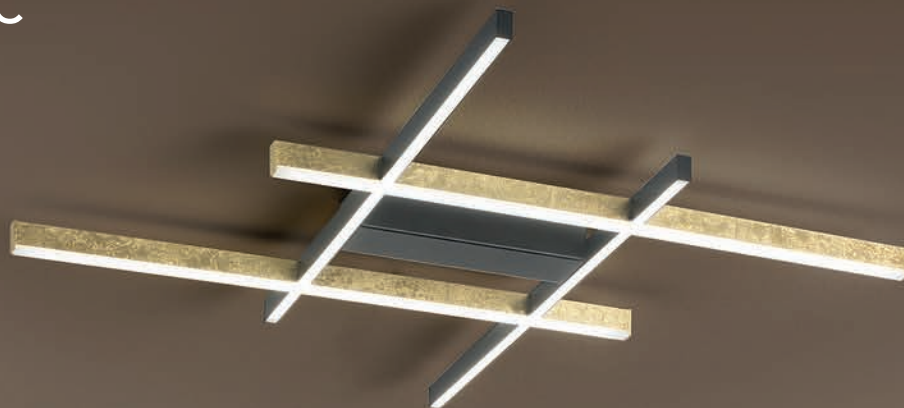

10



2154/PL110

BRAGA LED





GEOMETRIC

CRI > 80

DIMMERABILE / DIMMABLE

Vai a pagina / Go to page 457

DIFFUSORE / DIFFUSER

Metacrilato opalino

Opaline-finish methacrylate

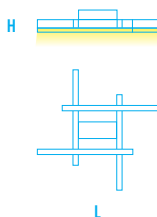

2154/PL70

W 38 - Vac 230

Lm 2.600

M 2.700°K

C 3.000°K - W 4.000°K

L 700 x 700 mm

H 70 mm

DIMMERABILE / DIMMABLE

2154/PL70 - D4

Taglio di fase / Phase Cut

2154/PL70 - D6

1-10V - DALI - PUSH

2154/PL70 - D7

ZigBee

2154/PL70 - D8

CASAMBI

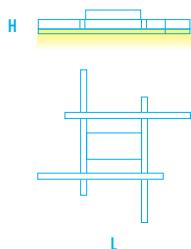

2154/PL90

W 49 - Vac 230

Lm 3.300

M 2.700°K

C 3.000°K - W 4.000°K

L 900 x 900 mm

H 70 mm

DIMMERABILE / DIMMABLE

2154/PL90 - D4

Taglio di fase / Phase Cut

2154/PL90 - D6

1-10V - DALI - PUSH

2154/PL90 - D7

ZigBee

2154/PL90 - D8

CASAMBI

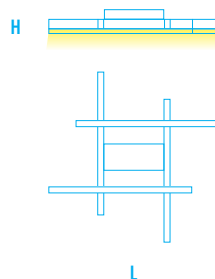

2154/PL110

W 59 - Vac 230

Lm 4.000

M 2.700°K

C 3.000°K - W 4.000°K

L 1.100 x 1.100 mm

H 70 mm

DIMMERABILE / DIMMABLE

2154/PL110 - D4

Taglio di fase / Phase Cut

2154/PL110 - D6

1-10V - DALI - PUSH

2154/PL110 - D7

ZigBee

2154/PL110 - D8

CASAMBI

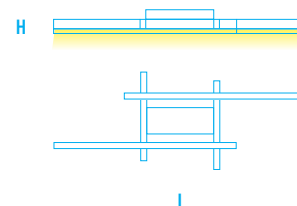

2154/PL130

W 49 - Vac 230

Lm 3.300

M 2.700°K

C 3.000°K - W 4.000°K

L 1.300 x 500 mm

H 70 mm

DIMMERABILE / DIMMABLE

2154/PL130 - D4

Taglio di fase / Phase Cut

2154/PL130 - D6

1-10V - DALI - PUSH

2154/PL130 - D7

ZigBee

2154/PL130 - D8

CASAMBI

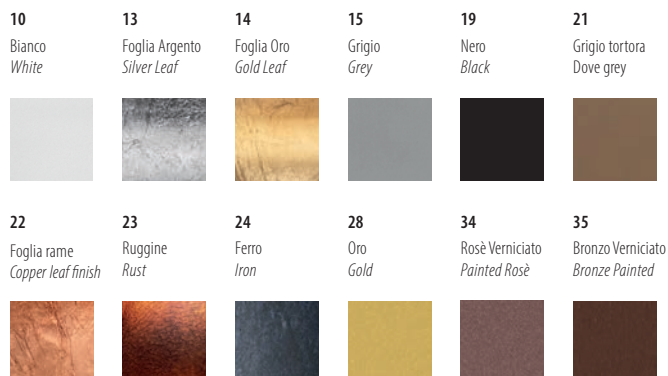

BICOLORE / TWO-TONE

Vai a pagina / Go to page 454



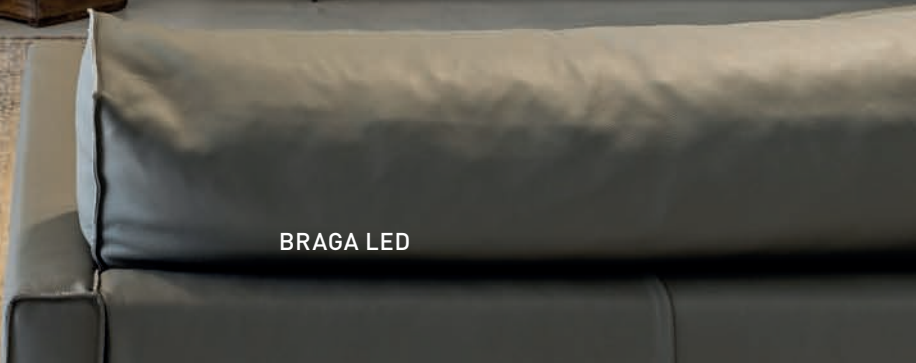

GEOMETRIC

CRI > 80

DIMMERABILE / DIMMABLE

Vai a pagina / Go to page 457

DIFFUSORE / DIFFUSER

Metacrilato opalino

Opaline-finish methacrylate

ATTENZIONE: Alimentatore non incluso

CAUTION: Power supply not included

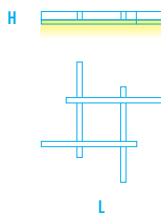

2154/TR70

W 38 - Vdc 24

Lm 2.600

M 2.700°K

C 3.000°K - W 4.000°K

L 700 x 700 mm

H 40 mm

ALIMENTATORE REMOTO
REMOTE POWER SUPPLY

ON-OFF
AL.60-24

DIMMERABILE / DIMMABLE

AL.50-24 - D4

Taglio di fase / Phase Cut

AL.60-24 - D6

1-10V - DALI - PUSH

AL.60-24 - D7

ZigBee

AL.60-24 - D8

CASAMBI

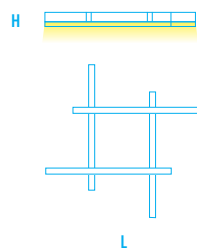

2154/TR90

W 49 - Vac 24

Lm 3.300

M 2.700°K

C 3.000°K - W 4.000°K

L 900 x 900 mm

H 40 mm

ALIMENTATORE REMOTO
REMOTE POWER SUPPLY

ON-OFF
AL.60-24

DIMMERABILE / DIMMABLE

AL.75-24 - D4

Taglio di fase / Phase Cut

AL.60-24 - D6

1-10V - DALI - PUSH

AL.60-24 - D7

ZigBee

AL.60-24 - D8

CASAMBI

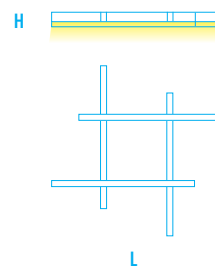

2154/TR110

W 59 - Vdc 24

Lm 4.000

M 2.700°K

C 3.000°K - W 4.000°K

L 1.100 x 1.100 mm

H 40 mm

ALIMENTATORE REMOTO
REMOTE POWER SUPPLY

ON-OFF
AL.100-24

DIMMERABILE / DIMMABLE

AL.75-24 - D4

Taglio di fase / Phase Cut

AL.100-24 - D6

1-10V - DALI - PUSH

AL.100-24 - D7

ZigBee

AL.100-24 - D8

CASAMBI

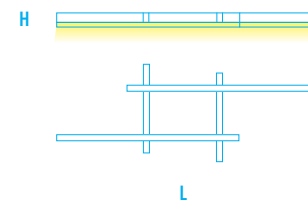

2154/TR130

W 49 - Vac 24

Lm 3.300

M 2.700°K

C 3.000°K - W 4.000°K

L 1.300 x 500 mm

H 40 mm

ALIMENTATORE REMOTO
REMOTE POWER SUPPLY

ON-OFF
AL.60-24

DIMMERABILE / DIMMABLE

AL.75-24 - D4

Taglio di fase / Phase Cut

AL.60-24 - D6

1-10V - DALI - PUSH

AL.60-24 - D7

ZigBee

AL.60-24 - D8

CASAMBI

15

10

Bianco
White



13

Foglia Argento
Silver Leaf



14

Foglia Oro
Gold Leaf



15

Grigio
Grey



19

Nero
Black



21

Grigio tortora
Dove grey



22

Foglia rame
Copper leaf finish



23

Ruggine
Rust



24

Ferro
Iron



28

Oro
Gold



34

Rosè Verniciato
Painted Rosè



35

Bronzo Verniciato
Bronze Painted



BICOLORE / TWO-TONE

Vai a pagina / Go to page 454

19

Nero
Black

/

14

Foglia Oro
Gold Leaf



24

Ferro
Iron

/

13

Foglia Argento
Silver Leaf



10

Bianco
White

/

22

Foglia rame
Copper leaf



GEOMETRIC

CRI > 80

DIMMERABILE / DIMMABLE

Vai a pagina / Go to page 457

DIFFUSORE / DIFFUSER

Metacrilato opalino

Opaline-finish methacrylate

*** ROSONE / CANOPY**

Informazioni Tecniche vai a pag. 455

Technical info go to page 455



Ø

Rosone da incasso
Recessed canopy

Max 3,2 Kg

16

2146/R35

Ø 45 mm

H 35 mm

Ø 35 mm



Alimentatore Remoto
Remote Power Supply

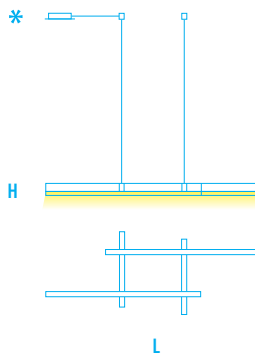

2154/S130-1

W 49 - Vac 230

Lm 3.300

M 2.700°K

C 3.000°K - W 4.000°K

L 1.300 x 500 mm

H 40 mm

L CAVI / CABLES 2.000 mm

DIMMERABILE / DIMMABLE

2154/S130-1 - D4

Taglio di fase / Phase Cut

2154/S130-1 - D6

1-10V - DALI - PUSH

2154/S130-1 - D7

ZigBee

2154/S130-1 - D8

CASAMBI

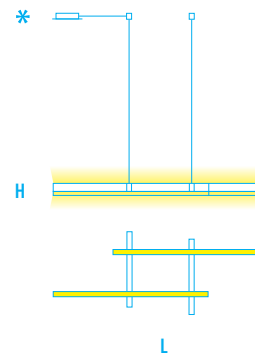

2154/S130-2

W 80 - Vac 230

Lm 3.300 (down) - 2.200 (up)

M 2.700°K

C 3.000°K - W 4.000°K

L 1.300 x 500 mm

H 40 mm

L CAVI / CABLES 2.000 mm

DIMMERABILE / DIMMABLE

2154/S130-2 - D4

Taglio di fase / Phase Cut

2154/S130-2 - D6

1-10V - DALI - PUSH

2154/S130-2 - D7

ZigBee

2154/S130-2 - D8

CASAMBI

10

Bianco
White



13

Foglia Argento
Silver Leaf



14

Foglia Oro
Gold Leaf



15

Grigio
Grey



19

Nero
Black



21

Grigio tortora
Dove grey



22

Foglia rame
Copper leaf finish



23

Ruggine
Rust



24

Ferro
Iron



28

Oro
Gold



34

Rosè Verniciato
Painted Rosè



35

Bronzo Verniciato
Bronze Painted



BICOLORE / TWO-TONE

Vai a pagina / Go to page 454

19

Nero
Black

/

14

Foglia Oro
Gold Leaf



24

Ferro
Iron

/

13

Foglia Argento
Silver Leaf



10

Bianco
White

/

22

Foglia rame
Copper leaf





Nets

18





NETS

CRI > 80

DIMMERABILE / DIMMABLE

Vai a pagina / Go to page 457

DIFFUSORE / DIFFUSER

Metacrilato opalino

Opaline-finish methacrylate



2155/A1

W 19 - Vac 230

Lm 1.250

M 2.700°K - C 3.000°K - W 4.000°K

L 510 x 390 mm

SP 80 mm

DIMMERABILE / DIMMABLE

2155/A1-D1 PUSH

2155/A1-D3 DALI

2155/A1-D4

Taglio di fase / Phase Cut



2155/A2

W 28 - Vac 230

Lm 1.800

M 2.700°K - C 3.000°K - W 4.000°K

L 510 x 540 mm

SP 80 mm

DIMMERABILE / DIMMABLE

2155/A2-D1 PUSH

2155/A2-D3 DALI

2155/A2-D4

Taglio di fase / Phase Cut

20

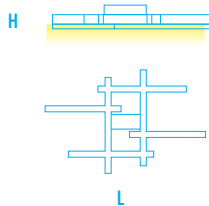

2155/PL95

W 53 - Vac 230

Lm 3.600

M 2.700°K

C 3.000°K - W 4.000°K

L 870 x 670 mm

H 70 mm

DIMMERABILE / DIMMABLE

2155/PL95 - D4

Taglio di fase / Phase Cut

2155/PL95 - D6

1-10V - DALI - PUSH

2155/PL95 - D7

ZigBee

2155/PL95 - D8

CASAMBI

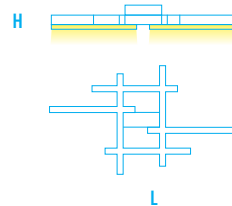

2155/PL115

W 59 - Vac 230

Lm 4.100

M 2.700°K

C 3.000°K - W 4.000°K

L 1.170 x 670 mm

H 70 mm

DIMMERABILE / DIMMABLE

2155/PL115 - D4

Taglio di fase / Phase Cut

2155/PL115 - D6

1-10V - DALI - PUSH

2155/PL115 - D7

ZigBee

2155/PL115 - D8

CASAMBI

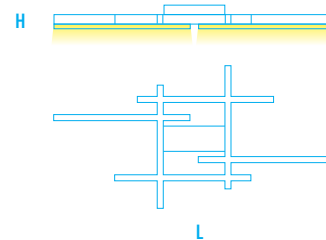

2155/PL145

W 70 - Vac 230

Lm 4.800

M 2.700°K

C 3.000°K - W 4.000°K

L 1.470 x 670 mm

H 70 mm

DIMMERABILE / DIMMABLE

2155/PL145 - D4

Taglio di fase / Phase Cut

2155/PL145 - D6

1-10V - DALI - PUSH

2155/PL145 - D7

ZigBee

2155/PL145 - D8

CASAMBI

10

Bianco
White



13

Foglia Argento
Silver Leaf



14

Foglia Oro
Gold Leaf



15

Grigio
Grey



19

Nero
Black



21

Grigio tortora
Dove grey



22

Foglia rame
Copper leaf finish



23

Ruggine
Rust



24

Ferro
Iron



28

Oro
Gold



34

Rosè Verniciato
Painted Rosè



35

Bronzo Verniciato
Bronze Painted



BICOLORE / TWO-TONE

Vai a pagina / Go to page 454

19

Nero
Black

/

14

Foglia Oro
Gold Leaf



24

Ferro
Iron

/

13

Foglia Argento
Silver Leaf



10

Bianco
White

/

22

Foglia rame
Copper leaf





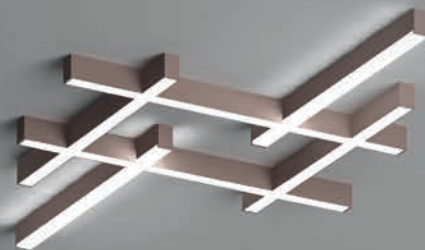
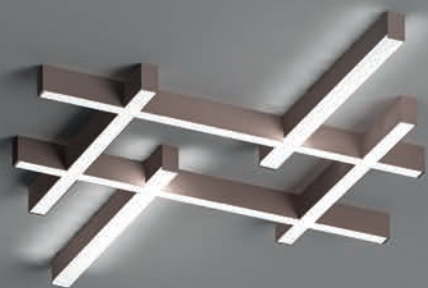

NETS

CRI > 80

DIMMERABILE / DIMMABLE

Vai a pagina / Go to page 457

DIFFUSORE / DIFFUSER

Metacrilato opalino

Opaline-finish methacrylate

ATTENZIONE: Alimentatore non incluso

CAUTION: Power supply not included

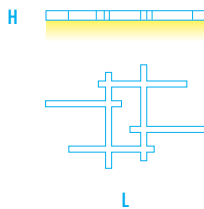

2155/TR95

W 53 - Vdc 24

Lm 3.600

M 2.700°K

C 3.000°K - W 4.000°K

L 870 x 670 mm

H 40 mm

ALIMENTATORE REMOTO
REMOTE POWER SUPPLY

ON-OFF
AL.60-24

DIMMERABILE / DIMMABLE

AL.75-24 - D4

Taglio di fase / Phase Cut

AL.60-24 - D6

1-10V - DALI - PUSH

AL.60-24 - D7

ZigBee

AL.60-24 - D8

CASAMBI

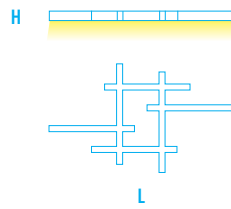

2155/TR115

W 59 - Vdc 24

Lm 4.100

M 2.700°K

C 3.000°K - W 4.000°K

L 1.170 x 670 mm

H 40 mm

ALIMENTATORE REMOTO
REMOTE POWER SUPPLY

ON-OFF
AL.100-24

DIMMERABILE / DIMMABLE

AL.75-24 - D4

Taglio di fase / Phase Cut

AL.100-24 - D6

1-10V - DALI - PUSH

AL.100-24 - D7

ZigBee

AL.100-24 - D8

CASAMBI

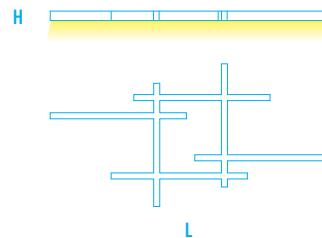

2155/TR145

W 70 - Vdc 24

Lm 4.800

M 2.700°K

C 3.000°K - W 4.000°K

L 1.470 x 670 mm

H 40 mm

ALIMENTATORE REMOTO
REMOTE POWER SUPPLY

ON-OFF
AL.100-24

DIMMERABILE / DIMMABLE

AL.75-24 - D4

Taglio di fase / Phase Cut

AL.100-24 - D6

1-10V - DALI - PUSH

AL.100-24 - D7

ZigBee

AL.100-24 - D8

CASAMBI

10

Bianco
White



13

Foglia Argento
Silver Leaf



14

Foglia Oro
Gold Leaf



15

Grigio
Grey



19

Nero
Black



21

Grigio tortora
Dove grey



22

Foglia rame
Copper leaf finish



23

Ruggine
Rust



24

Ferro
Iron



28

Oro
Gold



34

Rosè Verniciato
Painted Rosè



35

Bronzo Verniciato
Bronze Painted



BICOLORE / TWO-TONE

Vai a pagina / Go to page 454

19

Nero
Black

/

14

Foglia Oro
Gold Leaf



24

Ferro
Iron

/

13

Foglia Argento
Silver Leaf



10

Bianco
White

/

22

Foglia rame
Copper leaf





NETS

CRI > 80

DIMMERABILE / DIMMABLE

Vai a pagina / Go to page 457

DIFFUSORE / DIFFUSER

Metacrilato opalino

Opaline-finish methacrylate

*** ROSONE / CANOPY**

Informazioni Tecniche vai a pag. 455

Technical info go to page 455



Ø

Rosone da incasso

Recessed canopy

Max 3,2 Kg

2146/R35

Ø 45 mm

H 35 mm

Ø 35 mm



Alimentatore Remoto

Remote Power Supply

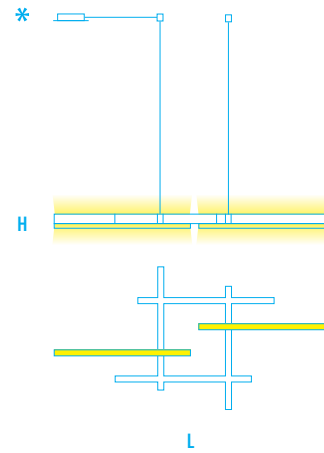
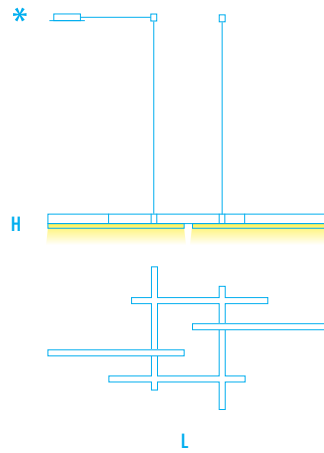

2155/S145-1

W 70 - Vac 230

Lm 4.800

M 2.700°K

C 3.000°K - W 4.000°K

L 1.470 x 670 mm

H 40 mm

L CAVI / CABLES 2.000 mm

DIMMERABILE / DIMMABLE

2155/S145-1 - D4

Taglio di fase / Phase Cut

2155/S145-1 - D6

1-10V - DALI - PUSH

2155/S145-1 - D7

ZigBee

2155/S145-1 - D8

CASAMBI

2155/S145-2

W 94 - Vac 230

Lm 4.800 (down) 1.700 (up)

M 2.700°K

C 3.000°K - W 4.000°K

L 1.470 x 670 mm

H 40 mm

L CAVI / CABLES 2.000 mm

DIMMERABILE / DIMMABLE

2155/S145-2 - D4

Taglio di fase / Phase Cut

2155/S145-2 - D6

1-10V - DALI - PUSH

2155/S145-2 - D7

ZigBee

2155/S145-2 - D8

CASAMBI

| | | | | | |
|--|--|--------------------------------------|-----------------------------|--|--|
| 10 Bianco White | 13 Foglia Argento Silver Leaf | 14 Foglia Oro Gold Leaf | 15 Grigio Grey | 19 Nero Black | 21 Grigio tortora Dove grey |
| | | | | | |
| 22 Foglia rame Copper leaf finish | 23 Ruggine Rust | 24 Ferro Iron | 28 Oro Gold | 34 Rosè Verniciato Painted Rosè | 35 Bronzo Verniciato Bronze Painted |
| | | | | | |

BICOLORE / TWO-TONE

Vai a pagina / Go to page 454

| | | |
|--------------------------------------|--|---|
| 19 Nero Black / | 24 Ferro Iron / | 10 Bianco White / |
| | | |
| 14 Foglia Oro Gold Leaf | 13 Foglia Argento Silver Leaf | 22 Foglia rame Copper leaf |
| | | |

NETS

CRI > 80

DIFFUSORE / DIFFUSER

Metacrilato opalino
Opaline-finish methacrylate

* ROSONE / CANOPY

Informazioni Tecniche vai a pag. 455
Technical info go to page 455



Ø

Rosone da incasso
Recessed canopy
Max 3,2 Kg

26 **2146/R35**

Ø 45 mm
H 35 mm
Ø 35 mm



Solo / Only
2155/S - 2155/S2
Alimentatore Remoto
Remote Power Supply

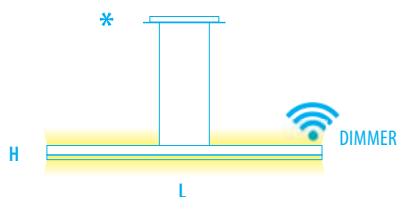

2155/S

W 46 - Vac 230
Lm 1.900 (Down) 1.300 (Up)
M 2.700°K
C 3.000°K - W 4.000°K
L 1.340 x 20 mm
H 38 mm
L CAVI / CABLES 2.000 mm
DIMMER OTTICO
OPTICAL DIMMER

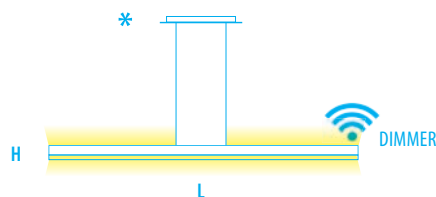

2155/S2

W 56 - Vac 230
Lm 2.300 (Down) 1.700 (Up)
M 2.700°K
C 3.000°K - W 4.000°K
L 1.590 x 20 mm
H 38 mm
L CAVI / CABLES 2.000 mm
DIMMER OTTICO
OPTICAL DIMMER

ROSONE CON CARRUCCOLE PER REGOLARE MANUALMENTE L'ALTEZZA DELLA LAMPADA CANOPY WITH ROLLS TO ADJUST MANUALLY PENDANT LAMP HEIGHT

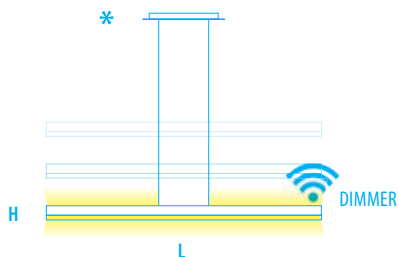

2155/S-G

W 46 - Vac 230
Lm 1.900 (Down) 1.300 (Up)
M 2.700°K
C 3.000°K - W 4.000°K
L 1.340 x 20 mm
H 38 mm
L CAVI / CABLES min.700 mm - max 2.400 mm
DIMMER OTTICO
OPTICAL DIMMER

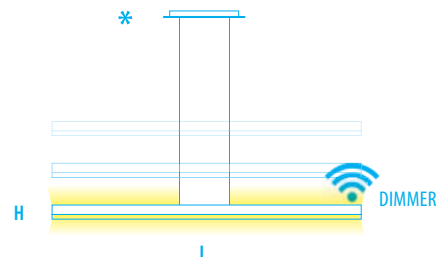

2155/S2-G

W 56 - Vac 230
Lm 2.300 (Down) 1.700 (Up)
M 2.700°K
C 3.000°K - W 4.000°K
L 1.590 x 20 mm
H 38 mm
L CAVI / CABLES min.700 mm - max 2.400 mm
DIMMER OTTICO
OPTICAL DIMMER

| | | | | | |
|--|--|--------------------------------------|-----------------------------|--|--|
| 10 Bianco White | 13 Foglia Argento Silver Leaf | 14 Foglia Oro Gold Leaf | 15 Grigio Grey | 19 Nero Black | 21 Grigio tortora Dove grey |
| | | | | | |
| 22 Foglia rame Copper leaf finish | 23 Ruggine Rust | 24 Ferro Iron | 28 Oro Gold | 34 Rosè Verniciato Painted Rosè | 35 Bronzo Verniciato Bronze Painted |
| | | | | | |





NETS

CRI > 80

DIMMERABILE / DIMMABLE

Vai a pagina / Go to page 457

DIFFUSORE / DIFFUSER

Metacrilato opalino

Opaline-finish methacrylate

ATTENZIONE: Alimentatore non incluso

CAUTION: Power supply not included



2155/TR66

W 12 - Vdc 24

Lm 800

M 2.700°K

C 3.000°K - W 4.000°K

L 660 x 20 mm

H 40 mm



2155/TR108

W 19 - Vdc 24

Lm 1.250

M 2.700°K

C 3.000°K - W 4.000°K

L 1.080 x 20 mm

H 40 mm



2155/TR134

W 23 - Vdc 24

Lm 1.500

M 2.700°K

C 3.000°K - W 4.000°K

L 1.340 x 20 mm

H 40 mm



2155/TR159

W 28 - Vdc 24

Lm 1.800

M 2.700°K

C 3.000°K - W 4.000°K

L 1.590 x 20 mm

H 40 mm

10

Bianco
White



13

Foglia Argento
Silver Leaf



14

Foglia Oro
Gold Leaf



15

Grigio
Grey



19

Nero
Black



21

Grigio tortora
Dove grey



22

Foglia rame
Copper leaf finish



23

Ruggine
Rust



24

Ferro
Iron



28

Oro
Gold



34

Rosè Verniciato
Painted Rosè



35

Bronzo Verniciato
Bronze Painted



Hug



30



2159/S90 + 2159/S50

BRAGA LED



HUG

SOLO LUCE DIRETTA
ONLY DIRECT LIGHT

CRI > 80

DIMMERABILE / DIMMABLE

Vai a pagina / Go to page 457

DIFFUSORE / DIFFUSER

Silicone opalino
Opaline-finish Silicone

*** ROSONE / CANOPY**

Informazioni Tecniche vai a pag. 455
Technical info go to page 455

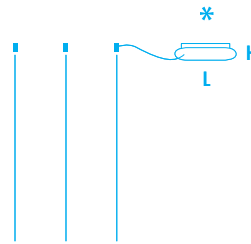
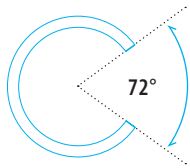

2159/S40-1
2159/S50-1

+

2129/R1-30

W 30 - Vac 230

H 45 mm
L 360x145 mm

DIMMERABILE / DIMMABLE

2129/R1-30 - D4

Taglio di fase / Phase Cut

2129/R1-30 - D6

1-10V - DALI - PUSH

2129/R1-30 - D7

ZigBee

2129/R1-30 - D8

CASAMBI

32

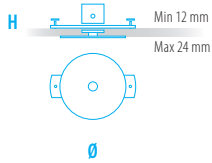

Rosone da incasso
Recessed canopy
Max 3,2 Kg

2146/R35

Ø 45 mm

H 35 mm

Ø 35 mm

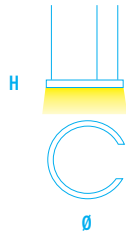

2159/S40-1

W 20 - Vac 230

Lm 1.200

M 2.700°K - C 3.000°K

W 4.000°K

H 40 mm

Ø 400 mm

L CAVI / CABLES 1.700 mm

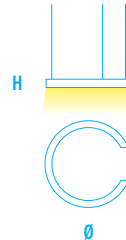

2159/S50-1

W 26 - Vac 230

Lm 1.550

M 2.700°K - C 3.000°K

W 4.000°K

H 40 mm

Ø 500 mm

L CAVI / CABLES 1.700 mm

10
Bianco
White



13
Foglia Argento
Silver Leaf



14
Foglia Oro
Gold Leaf



15
Grigio
Grey



19
Nero
Black



21
Grigio tortora
Dove grey



22
Foglia rame
Copper leaf



23
Ruggine
Rust



24
Ferro
Iron



28
Oro
Gold



29
Alluminio Spaz.
Brushed Alum.



30
Gunmetal



31
Rosé Spaz.
Brushed Rosé



32
Bronzo Spaz.
Brush. Bronze



33
Oro Spaz.
Brush. Gold



34
Rosé Verniciato
Painted Rosé



35
Bronzo Verniciato
Bronze Painted



BICOLORE / TWO-TONE

Vai a pagina / Go to page 454

19
Nero
Black

/



24
Ferro
Iron

/



10
Bianco
White

/



14
Foglia Oro
Gold Leaf



13
Foglia Argento
Silver Leaf



22
Foglia rame
Copper leaf





HUG

SOLO LUCE DIRETTA
ONLY DIRECT LIGHT

CRI > 80

DIMMERABILE / DIMMABLE

Vai a pagina / Go to page 457

DIFFUSORE / DIFFUSER

Silicone opalino
Opaline-finish Silicone

*** ROSONE / CANOPY**

Informazioni Tecniche vai a pag. 455
Technical info go to page 455

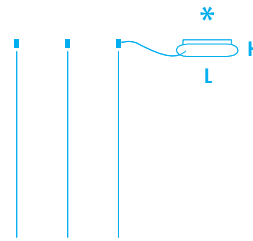
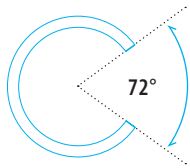

2159/S60-1
2159/S75-1
2159/S90-1



2129/R1-60

W 60 - Vac 230

H 45 mm

L 360x145 mm

DIMMERABILE / DIMMABLE

2129/R1-60 - D4

Taglio di fase / Phase Cut

2129/R1-60 - D6

1-10V - DALI - PUSH

2129/R1-60 - D7

ZigBee

2129/R1-60 - D8

CASAMBI

34

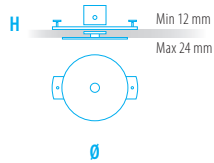

Rosone da incasso
Recessed canopy
Max 3,2 Kg

2146/R35

Ø 45 mm

H 35 mm

Ø 35 mm

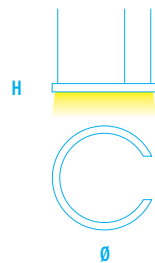

2159/S60-1

W 30 - Vac 230

Lm 1.800

M 2.700°K - C 3.000°K

W 4.000°K

H 40 mm

Ø 600 mm

L CAVI / CABLES 1.700 mm

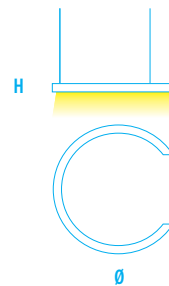

2159/S75-1

W 40 - Vac 230

Lm 2.400

M 2.700°K - C 3.000°K

W 4.000°K

H 40 mm

Ø 750 mm

L CAVI / CABLES 1.700 mm

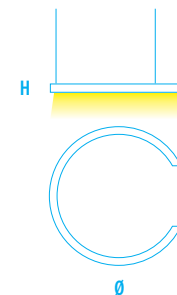

2159/S90-1

W 48 - Vac 230

Lm 2.850

M 2.700°K - C 3.000°K

W 4.000°K

H 40 mm

Ø 900 mm

L CAVI / CABLES 1.700 mm

10

Bianco
White



13

Foglia Argento
Silver Leaf



14

Foglia Oro
Gold Leaf



15

Grigio
Grey



19

Nero
Black



21

Grigio tortora
Dove grey



22

Foglia rame
Copper leaf



23

Ruggine
Rust



24

Ferro
Iron



28

Oro
Gold



29

Alluminio Spaz.
Brushed Alum.



30

Gunmetal



31

Rosé Spaz.
Brushed Rosé



32

Bronzo Spaz.
Brush. Bronze



33

Oro Spaz.
Brush. Gold



34

Rosé Verniciato
Painted Rosé



35

Bronzo Verniciato
Bronze Painted



BICOLORE / TWO-TONE

Vai a pagina / Go to page 454

19

Nero
Black

/

14

Foglia Oro
Gold Leaf



24

Ferro
Iron

/

13

Foglia Argento
Silver Leaf



10

Bianco
White

/

22

Foglia rame
Copper leaf



HUG

SOLO LUCE DIRETTA
ONLY DIRECT LIGHT

CRI > 80

DIMMERABILE / DIMMABLE

Vai a pagina / Go to page 457

DIFFUSORE / DIFFUSER

Silicone opalino
Opaline-finish Silicone

*** ROSONE / CANOPY**

Informazioni Tecniche vai a pag. 455
Technical info go to page 455

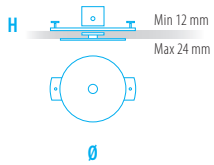
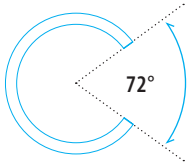

Rosone da incasso
Recessed canopy
Max 3,2 Kg

2146/R35

Ø 45 mm
H 35 mm
Ø 35 mm



2159/S120-1
2159/S150-1

+

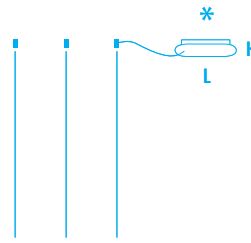

2129/R1-100

W 100 - Vac 230
H 45 mm
L 360x145 mm

DIMMERABILE / DIMMABLE

2129/R1-100 - D4

Taglio di fase / Phase Cut

2129/R1-100 - D6

1-10V - DALI - PUSH

2129/R1-100 - D7

ZigBee

2129/R1-100 - D8

CASAMBI

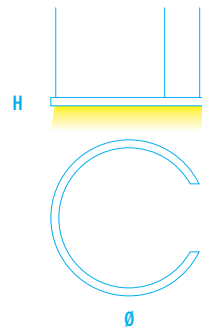

2159/S120-1

W 63 - Vac 230

Lm 3.750
M 2.700°K - C 3.000°K
W 4.000°K

H 40 mm
Ø 1.200 mm
L CAVI / CABLES 1.700 mm

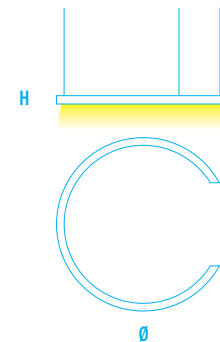

2159/S150-1

W 80 - Vac 230

Lm 4.800
M 2.700°K - C 3.000°K
W 4.000°K

H 40 mm
Ø 1.500 mm
L CAVI / CABLES 1.700 mm

10
Bianco
White



13
Foglia Argento
Silver Leaf



14
Foglia Oro
Gold Leaf



15
Grigio
Grey



19
Nero
Black



21
Grigio tortora
Dove grey



22
Foglia rame
Copper leaf



23
Ruggine
Rust



24
Ferro
Iron



28
Oro
Gold



29
Alluminio Spaz.
Brushed Alum.



30
Gunmetal



31
Rosé Spaz.
Brushed Rosé



32
Bronzo Spaz.
Brush. Bronze



33
Oro Spaz.
Brush. Gold



34
Rosé Verniciato
Painted Rosé



35
Bronzo Verniciato
Bronze Painted



BICOLORE / TWO-TONE

Vai a pagina / Go to page 454

19
Nero
Black
/



24
Ferro
Iron
/



10
Bianco
White
/



14
Foglia Oro
Gold Leaf



13
Foglia Argento
Silver Leaf



22
Foglia rame
Copper leaf



HUG

LUCE DIRETTA + INDIRETTA
DIRECT + INDIRECT LIGHT

CRI > 80

DIMMERABILE / DIMMABLE

Vai a pagina / Go to page 457

DIFFUSORE / DIFFUSER

Silicone opalino
Opaline-finish Silicone

*** ROSONE / CANOPY**

Informazioni Tecniche vai a pag. 455
Technical info go to page 455

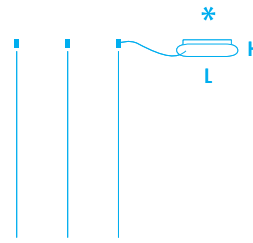
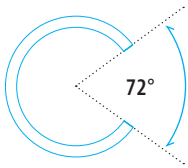

2159/S40-2
2159/S50-2



2129/R1-60

W 60 - Vac 230

H 45 mm

L 360x145 mm

DIMMERABILE / DIMMABLE

2129/R1-60 - D4

Taglio di fase / Phase Cut

2129/R1-60 - D6

1-10V - DALI - PUSH

2129/R1-60 - D7

ZigBee

2129/R1-60 - D8

CASAMBI

36

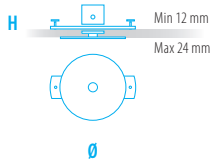

Rosone da incasso
Recessed canopy
Max 3,2 Kg

2146/R35

Ø 45 mm

H 35 mm

Ø 35 mm



2159/S40-2

W 40 - Vac 230

Lm 2.400

M 2.700°K - C 3.000°K

W 4.000°K

H 40 mm

Ø 400 mm

L CAVI / CABLES 1.700 mm



2159/S50-2

W 52 - Vac 230

Lm 3.100

M 2.700°K - C 3.000°K

W 4.000°K

H 40 mm

Ø 500 mm

L CAVI / CABLES 1.700 mm

10
Bianco
White



13
Foglia Argento
Silver Leaf



14
Foglia Oro
Gold Leaf



15
Grigio
Grey



19
Nero
Black



21
Grigio tortora
Dove grey



22
Foglia rame
Copper leaf



23
Ruggine
Rust



24
Ferro
Iron



28
Oro
Gold



29
Alluminio Spaz.
Brushed Alum.



30
Gunmetal



31
Rosé Spaz.
Brushed Rosé



32
Bronzo Spaz.
Brush. Bronze



33
Oro Spaz.
Brush. Gold



34
Rosé Verniciato
Painted Rosé



35
Bronzo Verniciato
Bronze Painted



BICOLORE / TWO-TONE

Vai a pagina / Go to page 454

19
Nero
Black
/



24
Ferro
Iron
/



10
Bianco
White
/



14
Foglia Oro
Gold Leaf



13
Foglia Argento
Silver Leaf



22
Foglia rame
Copper leaf





HUG

LUCE DIRETTA + INDIRECTA
DIRECT + INDIRECT LIGHT

CRI > 80

DIMMERABILE / DIMMABLE

Vai a pagina / Go to page 457

DIFFUSORE / DIFFUSER

Silicone opalino
Opaline-finish Silicone

*** ROSONE / CANOPY**

Informazioni Tecniche vai a pag. 455
Technical info go to page 455

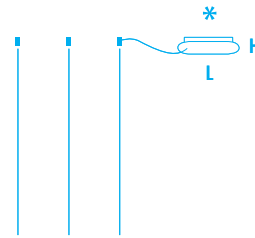
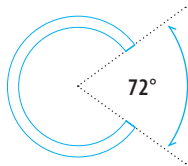

2159/S60-2
2159/S75-2
2159/S90-2



2129/R1-100

W 100 - Vac 230

H 45 mm

L 360x145 mm

DIMMERABILE / DIMMABLE

2129/R1-100 - D4

Taglio di fase / Phase Cut

2129/R1-100 - D6

1-10V - DALI - PUSH

2129/R1-100 - D7

ZigBee

2129/R1-100 - D8

CASAMBI

38

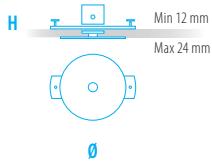

Rosone da incasso
Recessed canopy
Max 3,2 Kg

2146/R35

Ø 45 mm

H 35 mm

Ø 35 mm

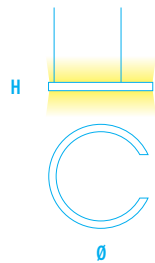

2159/S60-2

W 60 - Vac 230

Lm 3.600

M 2.700°K - C 3.000°K

W 4.000°K

H 40 mm

Ø 600 mm

L CAVI / CABLES 1.700 mm

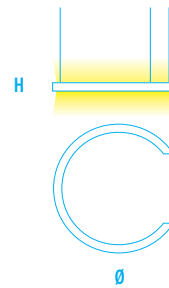

2159/S75-2

W 80 - Vac 230

Lm 4.800

M 2.700°K - C 3.000°K

W 4.000°K

H 40 mm

Ø 750 mm

L CAVI / CABLES 1.700 mm

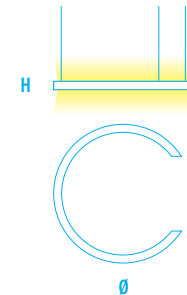

2159/S90-2

W 96 - Vac 230

Lm 5.700

M 2.700°K - C 3.000°K

W 4.000°K

H 40 mm

Ø 900 mm

L CAVI / CABLES 1.700 mm

10
Bianco
White



13
Foglia Oro
Silver Leaf



14
Foglia Oro
Gold Leaf



15
Grigio
Grey



19
Nero
Black



21
Grigio tortora
Dove grey



22
Foglia rame
Copper leaf



23
Ruggine
Rust



24
Ferro
Iron



28
Oro
Gold



29
Alluminio Spaz.
Brushed Alum.



30
Gunmetal



31
Rosé Spaz.
Brushed Rosé



32
Bronzo Spaz.
Brush. Bronze



33
Oro Spaz.
Brush. Gold



34
Rosé Verniciato
Painted Rosé



35
Bronzo Verniciato
Bronze Painted



BICOLORE / TWO-TONE

Vai a pagina / Go to page 454

19
Nero
Black
/

14
Foglia Oro
Gold Leaf



24
Ferro
Iron
/

13
Foglia Argento
Silver Leaf



10
Bianco
White
/

22
Foglia rame
Copper leaf



HUG

LUCE DIRETTA + INDIRECTA
DIRECT + INDIRECT LIGHT

CRI > 80

DIMMERABILE / DIMMABLE

Vai a pagina / Go to page 457

DIFFUSORE / DIFFUSER

Silicone opalino
Opaline-finish Silicone

*** ROSONE / CANOPY**

Informazioni Tecniche vai a pag. 455
Technical info go to page 455

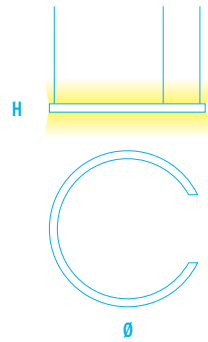
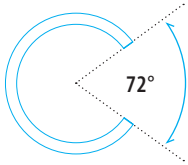

2159/S120-2

W 126 - Vac 230

Lm 7.500

M 2.700°K - C 3.000°K

W 4.000°K

H 40 mm

Ø 1.200 mm

L CAVI / CABLES 1.700 mm

+

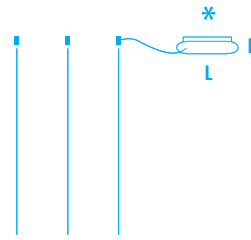

2129/R1-150

W 150 - Vac 230

H 45 mm

L 360x145 mm

DIMMERABILE / DIMMABLE

2129/R1-150 - D4

Taglio di fase / Phase Cut

2129/R1-150 - D6

1-10V - DALI - PUSH

2129/R1-150 - D7

ZigBee

2129/R1-150 - D8

CASAMBI

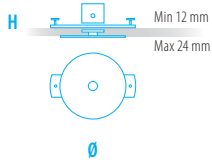

Rosone da incasso
Recessed canopy
Max 3,2 Kg

2146/R35

Ø 45 mm

H 35 mm

Ø 35 mm

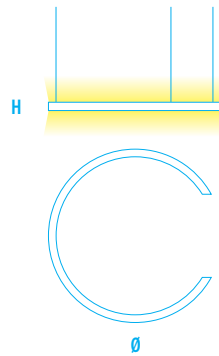

2159/S150-2

W 160 - Vac 230

Lm 9.400

M 2.700°K - C 3.000°K

W 4.000°K

H 40 mm

Ø 1.500 mm

L CAVI / CABLES 1.700 mm

+

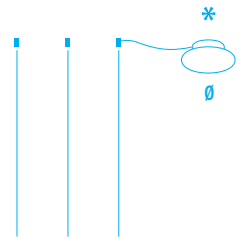

2129/R0-200

W 200 - Vac 230

H 45 mm

Ø 320 mm x Ø 260 mm

DIMMERABILE / DIMMABLE

2129/R0-200 - D4

Taglio di fase / Phase Cut

2129/R0-200 - D6

1-10V - DALI - PUSH

2129/R0-200 - D7

ZigBee

2129/R0-200 - D8

CASAMBI

10

Bianco
White



13

Foglia Argento
Silver Leaf



14

Foglia Oro
Gold Leaf



15

Grigio
Grey



19

Nero
Black



21

Grigio tortora
Dove grey



22

Foglia rame
Copper leaf



23

Ruggine
Rust



24

Ferro
Iron



28

Oro
Gold



29

Alluminio Spaz.
Brushed Alum.



30

Gunmetal



31

Rosé Spaz.
Brushed Rosé



32

Bronzo Spaz.
Brush. Bronze



33

Oro Spaz.
Brush. Gold



34

Rosé Verniciato
Painted Rosé



35

Bronzo Verniciato
Bronze Painted



BICOLORE / TWO-TONE

Vai a pagina / Go to page 454

19

Nero
Black

/

14

Foglia Oro
Gold Leaf



24

Ferro
Iron

/

13

Foglia Argento
Silver Leaf



10

Bianco
White

/

22

Foglia rame
Copper leaf



HUG

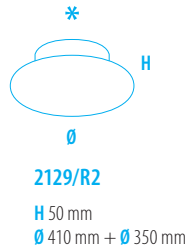
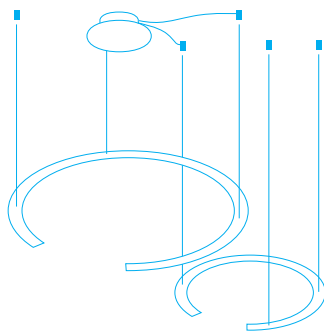

ESEMPIO D'ORDINE / EXAMPLE OF ORDER

- N.1 2159/S60-1 C10
- N.1 2159/S90-2 C10
- N.1 2129/R2-10
- N.1 AL 60-24
- N.1 AL 100-24

40

ON/OFF

- AL 30-24 (S40-1 / S50-1)
- AL 60-24 (S60-1 / S75-1 / S90-1 / S40-2 / S50-2)
- AL 100-24 (S120-1 / S150-1 / S60-2 / S75-2 / S90-2)
- AL 150-24 (S120-2)
- AL 200-24 (S150-2)

DIMMERABILE / DIMMABLE D4 (TAGLIO DI FASE/PHASE CUT)

- AL 30-24-D4 (S40-1 / S50-1)
- AL 50-24-D4 (S60-1 / S75-1 / S90-1 / S40-2)
- AL 75-24-D4 (S120-1 / S50-2 / S60-2)
- AL 100-24-D4 (S150-1 / S75-2 / S90-2)
- AL 200-24-D4 (S120-2 9/ S150-2)

DIMMERABILE / DIMMABLE D6 (1-10V-DALI-PUSH)

- AL 30-24-D6 (S40-1 / S50-1)
- AL 60-24-D6 (S60-1 / S75-1 / S90-1 / S40-2 / S50-2)
- AL 100-24-D6 (S120-1 / S150-1 / S60-2 / S75-2 / S90-2)
- AL 150-24-D6 (S120-2)
- AL 200-24-D6 (S150-2)

DIMMERABILE / DIMMABLE D7 (ZIGBEE)

- AL 30-24-D7 (S40-1 / S50-1)
- AL 60-24-D7 (S60-1 / S75-1 / S90-1 / S40-2 / S50-2)
- AL 100-24-D7 (S120-1 / S150-1 / S60-2 / S75-2 / S90-2)
- AL 150-24-D7 (S120-2)
- AL 200-24-D7 (S150-2)

DIMMERABILE / DIMMABLE D8 (CASAMBI)

- AL 30-24-D8 (S40-1 / S50-1)
- AL 60-24-D8 (S60-1 / S75-1 / S90-1 / S40-2 / S50-2)
- AL 100-24-D8 (S120-1 / S150-1 / S60-2 / S75-2 / S90-2)
- AL 150-24-D8 (S120-2)
- AL 200-24-D8 (S150-2)

* ROSONE / CANOPY

Informazioni Tecniche vai a pag. 453
Technical info go to page 453

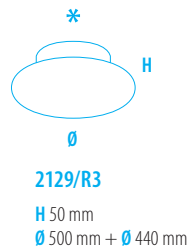
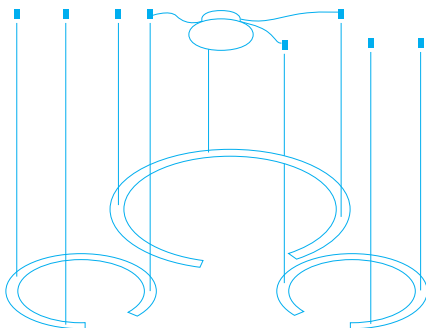

ESEMPIO D'ORDINE / EXAMPLE OF ORDER

- N.1 2159/S50-1 C19
- N.1 2159/S90-1 C19
- N.1 2159/S120-2 C19
- N.1 2129/R3-19
- N.1 AL 30-24 - D4
- N.1 AL 50-24 - D4
- N.1 AL 200-24 - D4

| | | | | | | | | |
|-----------------------|-------------------------------------|--|----------------------|----------------------------------|-------------------------------------|----------------------------------|---------------------------------------|---|
| 10 Bianco White | 13 Foglia Argento Silver Leaf | 14 Foglia Oro Gold Leaf | 15 Grigio Grey | 19 Nero Black | 21 Grigio tortora Dove grey | 22 Foglia rame Copper leaf | 23 Ruggine Rust | |
| 24 Ferro Iron | 28 Oro Gold | 29 Alluminio Spaz. Brushed Alum. | 30 Gunmetal | 31 Rosè Spaz. Brushed Rosè | 32 Bronzo Spaz. Brush. Bronze | 33 Oro Spaz. Brush. Gold | 34 Rosè Verniciato Painted Rosè | 35 Bronzo Verniciato Bronze Painted |





HUG

SOLO LUCE DIRETTA
ONLY DIRECT LIGHT

CRI > 80

DIMMERABILE / DIMMABLE

Vai a pagina / Go to page 457

DIFFUSORE / DIFFUSER

Silicone opalino
Opaline-finish Silicone

*** ROSONE / CANOPY**

Informazioni Tecniche vai a pag. 455
Technical info go to page 455

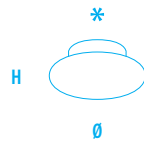
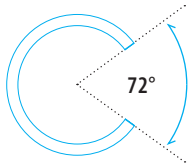

2133/R

Rosone con Alimentatore 75W
Base whit Power Supply 75W

H 30 mm
Ø 220 mm + Ø 190 mm

DIMMERABILE / DIMMABLE

2133/R - D4

Taglio di fase / Phase Cut

2133/R - D6

1-10V - DALI - PUSH

2133/R - D8

CASAMBI



2159/TR40

W 20 - Vdc 24

Lm 1.200
M 2.700°K - C 3.000°K
W 4.000°K

H 40 mm
Ø 400 mm

ALIMENTATORE REMOTO
REMOTE POWER SUPPLY

ON/OFF
AL. 30-24

DIMMERABILE / DIMMABLE

AL.30-24 - D4

Taglio di fase / Phase Cut

AL.30-24 - D6

1-10V - DALI - PUSH

AL.30-24 - D7

ZigBee

AL.30-24 - D8

CASAMBI



2159/TR50

W 26 - Vdc 24

Lm 1.550
M 2.700°K - C 3.000°K
W 4.000°K

H 40 mm
Ø 500 mm

ALIMENTATORE REMOTO
REMOTE POWER SUPPLY

ON/OFF
AL. 30-24

DIMMERABILE / DIMMABLE

AL.30-24 - D4

Taglio di fase / Phase Cut

AL.30-24 - D6

1-10V - DALI - PUSH

AL.30-24 - D7

ZigBee

AL.30-24 - D8

CASAMBI

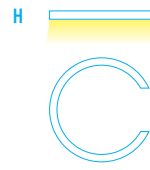

2159/TR60

W 30 - Vdc 24

Lm 1.800
M 2.700°K - C 3.000°K
W 4.000°K

H 40 mm
Ø 600 mm

ALIMENTATORE REMOTO
REMOTE POWER SUPPLY

ON/OFF
AL. 60-24

DIMMERABILE / DIMMABLE

AL.50-24 - D4

Taglio di fase / Phase Cut

AL.60-24 - D6

1-10V - DALI - PUSH

AL.60-24 - D7

ZigBee

AL.60-24 - D8

CASAMBI

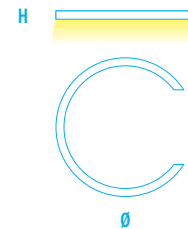

2159/TR75

W 40 - Vdc 24

Lm 2.400
M 2.700°K - C 3.000°K
W 4.000°K

H 40 mm
Ø 750 mm

ALIMENTATORE REMOTO
REMOTE POWER SUPPLY

ON/OFF
AL. 60-24

DIMMERABILE / DIMMABLE

AL.50-24 - D4

Taglio di fase / Phase Cut

AL.60-24 - D6

1-10V - DALI - PUSH

AL.60-24 - D7

ZigBee

AL.60-24 - D8

CASAMBI

10
Bianco
White



13
Foglia Argento
Silver Leaf



14
Foglia Oro
Gold Leaf



15
Grigio
Grey



19
Nero
Black



21
Grigio tortora
Dove grey



22
Foglia rame
Copper leaf



23
Ruggine
Rust



24
Ferro
Iron



28
Oro
Gold



29
Alluminio Spaz.
Brushed Alum.



30
Gunmetal



31
Rosé Spaz.
Brushed Rosé



32
Bronzo Spaz.
Brush. Bronze



33
Oro Spaz.
Brush. Gold



34
Rosé Verniciato
Painted Rosé



35
Bronzo Verniciato
Bronze Painted



BICOLORE / TWO-TONE

Vai a pagina / Go to page 454

19
Nero
Black
/

14
Foglia Oro
Gold Leaf



24
Ferro
Iron
/

13
Foglia Argento
Silver Leaf



10
Bianco
White
/

22
Foglia rame
Copper leaf



HUG

SOLO LUCE DIRETTA
ONLY DIRECT LIGHT

CRI > 80

DIMMERABILE / DIMMABLE

Vai a pagina / Go to page 457

DIFFUSORE / DIFFUSER

Silicone opalino
Opaline-finish Silicone

*** ROSONE / CANOPY**

Informazioni Tecniche vai a pag. 455
Technical info go to page 455

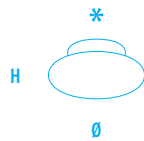
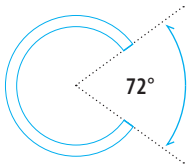

2133/R

Rosone con Alimentatore 75W
Base whit Power Supply 75W

H 30 mm
Ø 220 mm + Ø 190 mm

DIMMERABILE / DIMMABLE

2133/R - D4

Taglio di fase / Phase Cut

2133/R - D6

1-10V - DALI - PUSH

2133/R - D8

CASAMBI

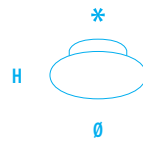

2129/R220-0-150

Rosone con Alimentatore 150W
Base whit Power Supply 150W

H 45 mm
Ø 280 mm + Ø 220 mm

DIMMERABILE / DIMMABLE

2129/R220-0-150 - D4

Taglio di fase / Phase Cut

2129/R220-0-150 - D6

1-10V - DALI - PUSH

2129/R220-0-150 - D8

CASAMBI

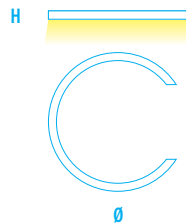

2159/TR90

W 48 - Vdc 24

Lm 2.850
M 2.700°K - C 3.000°K
W 4.000°K

H 40 mm
Ø 900 mm

ALIMENTATORE REMOTO
REMOTE POWER SUPPLY

ON/OFF

AL. 60-24

DIMMERABILE / DIMMABLE

AL.50-24 - D4

Taglio di fase / Phase Cut

AL.60-24 - D6

1-10V - DALI - PUSH

AL.60-24 - D7

ZigBee

AL.60-24 - D8

CASAMBI

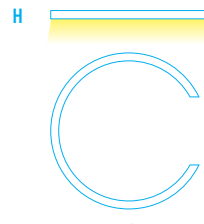

2159/TR120

W 63 - Vdc 24

Lm 3.750
M 2.700°K - C 3.000°K
W 4.000°K

H 40 mm
Ø 1.200 mm

ALIMENTATORE REMOTO
REMOTE POWER SUPPLY

ON/OFF

AL. 100-24

DIMMERABILE / DIMMABLE

AL.75-24 - D4

Taglio di fase / Phase Cut

AL.100-24 - D6

1-10V - DALI - PUSH

AL.100-24 - D7

ZigBee

AL.100-24 - D8

CASAMBI

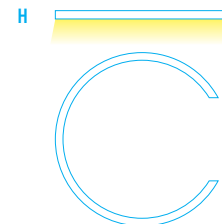

2159/TR150

W 80 - Vdc 24

Lm 4.800
M 2.700°K - C 3.000°K
W 4.000°K

H 40 mm
Ø 1.500 mm

ALIMENTATORE REMOTO
REMOTE POWER SUPPLY

ON/OFF

AL. 100-24

DIMMERABILE / DIMMABLE

AL.100-24 - D4

Taglio di fase / Phase Cut

AL.100-24 - D6

1-10V - DALI - PUSH

AL.100-24 - D7

ZigBee

AL.100-24 - D8

CASAMBI

10
Bianco
White



13
Foglia Argento
Silver Leaf



14
Foglia Oro
Gold Leaf



15
Grigio
Grey



19
Nero
Black



21
Grigio tortora
Dove grey



22
Foglia rame
Copper leaf



23
Ruggine
Rust



24
Ferro
Iron



28
Oro
Gold



29
Alluminio Spaz.
Brushed Alum.



30
Gunmetal



31
Rosé Spaz.
Brushed Rosé



32
Bronzo Spaz.
Brush. Bronze



33
Oro Spaz.
Brush. Gold



34
Rosé Verniciato
Painted Rosé



35
Bronzo Verniciato
Bronze Painted



BICOLORE / TWO-TONE

Vai a pagina / Go to page 454

19
Nero
Black



24
Ferro
Iron



10
Bianco
White



14
Foglia Oro
Gold Leaf



13
Foglia Argento
Silver Leaf



22
Foglia rame
Copper leaf





Loop

46





LOOP

2129/S50-S75-S150

LOOP

SOLO LUCE DIRETTA
ONLY DIRECT LIGHT

CRI > 80

DIMMERABILE / DIMMABLE

Vai a pagina / Go to page 457

DIFFUSORE / DIFFUSER

Silicone opalino
Opaline-finish Silicone

*** ROSONE / CANOPY**

Informazioni Tecniche vai a pag. 455
Technical info go to page 455

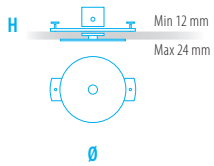

48 Rosone da incasso
Recessed canopy
Max 3,2 Kg

2146/R35

Ø 45 mm

H 35 mm

Ø 35 mm

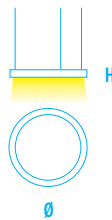

2129/S40-1

W 25 - Vdc 24

Lm 1.500

M 2.700°K - C 3.000°K

W 4.000°K

H 40 mm

L CAVI / CABLES 1.700 mm

Ø 400 mm

+

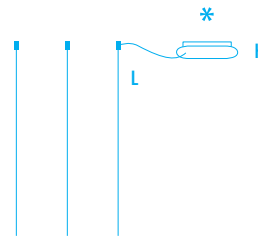

2129/R1-30

W 30 - Vac 230

H 45 mm

L 360x145 mm

DIMMERABILE / DIMMABLE

2129/R1-30 - D4

Taglio di fase / Phase Cut

2129/R1-30 - D6

1-10V - DALI - PUSH

2129/R1-30 - D7

ZigBee

2129/R1-30 - D8

CASAMBI

O/OR

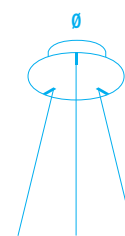

2129/R220-30

W 30 - Vac 230

H 45 mm

Ø 280 mm + Ø 220 mm

DIMMERABILE / DIMMABLE

2129/R220-30 - D4

Taglio di fase / Phase Cut

2129/R220-30 - D6

1-10V - DALI - PUSH

2129/R220-30 - D7

ZigBee

2129/R220-30 - D8

CASAMBI

10

Bianco
White



13

Foglia Argento
Silver Leaf



14

Foglia Oro
Gold Leaf



15

Grigio
Grey



19

Nero
Black



21

Grigio tortora
Dove grey



22

Foglia rame
Copper leaf



23

Ruggine
Rust



24

Ferro
Iron



28

Oro
Gold



29

Alluminio Spaz.
Brushed Alum.



30

Gunmetal



31

Rosé Spaz.
Brushed Rosé



32

Bronzo Spaz.
Brush. Bronze



33

Oro Spaz.
Brush. Gold



34

Rosé Verniciato
Painted Rosé



35

Bronzo Verniciato
Bronze Painted



BICOLORE / TWO-TONE

Vai a pagina / Go to page 454

19

Nero
Black

/

/

14

Foglia Oro
Gold Leaf



24

Ferro
Iron

/

/

13

Foglia Argento
Silver Leaf



10

Bianco
White

/

/

22

Foglia rame
Copper leaf





LOOP

2129/S50-2 + 2129/TR90
+ 2146/R35 + Alimentatore remoto / Remote power supply

LOOP

SOLO LUCE DIRETTA
ONLY DIRECT LIGHT

CRI > 80

DIMMERABILE / DIMMABLE

Vai a pagina / Go to page 457

DIFFUSORE / DIFFUSER

Silicone opalino
Opaline-finish Silicone

*** ROSONE / CANOPY**

Informazioni Tecniche vai a pag. 455
Technical info go to page 455

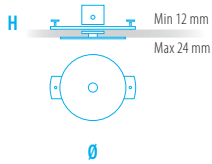

50 Rosone da incasso
Recessed canopy
Max 3,2 Kg

2146/R35

Ø 45 mm
H 35 mm
Ø 35 mm

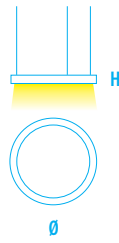

2129/S50-1

W 32 - Vdc 24

Lm 1.900
M 2.700°K - C 3.000°K
W 4.000°K

H 40 mm
L CAVI / CABLES 1.700 mm
Ø 500 mm

+

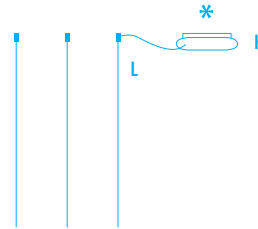

2129/R1-60

W 60 - Vac 230

H 45 mm
L 360x145 mm

DIMMERABILE / DIMMABLE

2129/R1-60 - D4
Taglio di fase / Phase Cut

2129/R1-60 - D6
1-10V - DALI - PUSH

2129/R1-60 - D7
ZigBee

2129/R1-60 - D8
CASAMBI

O/OR

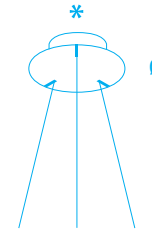

2129/R220-60

W 60 - Vac 230

H 45 mm
Ø 280 mm + Ø 220 mm

DIMMERABILE / DIMMABLE

2129/R220-60 - D4
Taglio di fase / Phase Cut

2129/R220-60 - D6
1-10V - DALI - PUSH

2129/R220-60 - D7
ZigBee

2129/R220-60 - D8
CASAMBI

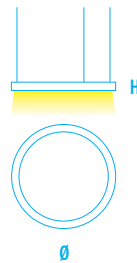

2129/S60-1

W 38 - Vdc 24

Lm 2.300
M 2.700°K - C 3.000°K
W 4.000°K

H 40 mm
L CAVI / CABLES 1.700 mm
Ø 600 mm

+

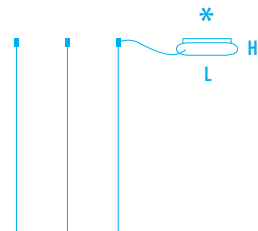

2129/R1-60

W 60 - Vac 230

H 45 mm
L 360x145 mm

DIMMERABILE / DIMMABLE

2129/R1-60 - D4
Taglio di fase / Phase Cut

2129/R1-60 - D6
1-10V - DALI - PUSH

2129/R1-60 - D7
ZigBee

2129/R1-60 - D8
CASAMBI

O/OR

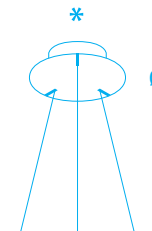

2129/R220-60

W 60 - Vac 230

H 45 mm
Ø 280 mm + Ø 220 mm

DIMMERABILE / DIMMABLE

2129/R220-60 - D4
Taglio di fase / Phase Cut

2129/R220-60 - D6
1-10V - DALI - PUSH

2129/R220-60 - D7
ZigBee

2129/R220-60 - D8
CASAMBI

10 Bianco
White



13 Foglia Argento
Silver Leaf



14 Foglia Oro
Gold Leaf



15 Grigio
Grey



19 Nero
Black



21 Grigio tortora
Dove grey



22 Foglia rame
Copper leaf



23 Ruggine
Rust



24 Ferro
Iron



28 Oro
Gold



29 Alluminio Spaz.
Brushed Alum.



30 Gunmetal



31 Rosé Spaz.
Brushed Rosé



32 Bronzo Spaz.
Brush. Bronze



33 Oro Spaz.
Brush. Gold



34 Rosé Verniciato
Painted Rosé



35 Bronzo Verniciato
Bronze Painted



BICOLORE / TWO-TONE

Vai a pagina / Go to page 454

19 Nero
Black

/

14 Foglia Oro
Gold Leaf



24 Ferro
Iron

/

13 Foglia Argento
Silver Leaf



10 Bianco
White

/

22 Foglia rame
Copper leaf







LOOP

SOLO LUCE DIRETTA
ONLY DIRECT LIGHT

CRI > 80

DIMMERABILE / DIMMABLE

Vai a pagina / Go to page 457

DIFFUSORE / DIFFUSER

Silicone opalino
Opaline-finish Silicone

*** ROSONE / CANOPY**

Informazioni Tecniche vai a pag. 455
Technical info go to page 455



Rosone da incasso
Recessed canopy
Max 3,2 Kg

2146/R35

Ø 45 mm
H 35 mm
Ø 35 mm

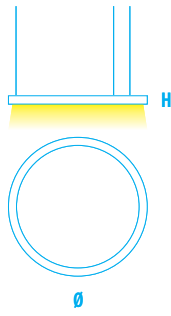

2129/S75-1

W 49 - Vdc 24

Lm 2.950

M 2.700°K - C 3.000°K

W 4.000°K

H 40 mm

L CAVI / CABLES 1.700 mm

Ø 750 mm

+

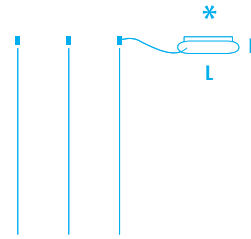

2129/R1-60

W 60 - Vac 230

H 45 mm

L 360x145 mm

DIMMERABILE / DIMMABLE

2129/R1-60 - D4

Taglio di fase / Phase Cut

2129/R1-60 - D6

1-10V - DALI - PUSH

2129/R1-60 - D7

ZigBee

2129/R1-60 - D8

CASAMBI

O/OR

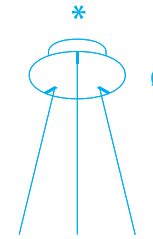

2129/R220-60

W 60 - Vac 230

H 45 mm

Ø 280 mm + Ø 220 mm

DIMMERABILE / DIMMABLE

2129/R220-60 - D4

Taglio di fase / Phase Cut

2129/R220-60 - D6

1-10V - DALI - PUSH

2129/R220-60 - D7

ZigBee

2129/R220-60 - D8

CASAMBI

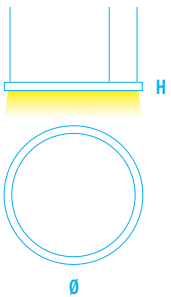

2129/S90-1

W 60 - Vdc 24

Lm 3.600

M 2.700°K - C 3.000°K

W 4.000°K

H 40 mm

L CAVI / CABLES 1.700 mm

Ø 900 mm

+

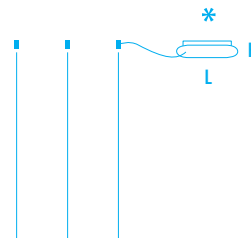

2129/R1-100

W 100 - Vac 230

H 45 mm

L 360x145 mm

DIMMERABILE / DIMMABLE

2129/R1-100 - D4

Taglio di fase / Phase Cut

2129/R1-100 - D6

1-10V - DALI - PUSH

2129/R1-100 - D7

ZigBee

2129/R1-100 - D8

CASAMBI

O/OR

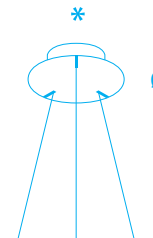

2129/R220-100

W 100 - Vac 230

H 45 mm

Ø 280 mm + Ø 220 mm

DIMMERABILE / DIMMABLE

2129/R220-100 - D4

Taglio di fase / Phase Cut

2129/R220-100 - D6

1-10V - DALI - PUSH

2129/R220-100 - D7

ZigBee

2129/R220-100 - D8

CASAMBI

10

Bianco
White



13

Foglia Argento
Silver Leaf



14

Foglia Oro
Gold Leaf



15

Grigio
Grey



19

Nero
Black



21

Grigio tortora
Dove grey



22

Foglia rame
Copper leaf



23

Ruggine
Rust



24

Ferro
Iron



28

Oro
Gold



29

Alluminio Spaz.
Brushed Alum.



30

Gunmetal



31

Rosé Spaz.
Brushed Rosé



32

Bronzo Spaz.
Brush. Bronze



33

Oro Spaz.
Brush. Gold



34

Rosé Verniciato
Painted Rosé



35

Bronzo Verniciato
Bronze Painted



BICOLORE / TWO-TONE

Vai a pagina / Go to page 454

19

Nero
Black

/

14

Foglia Oro
Gold Leaf



24

Ferro
Iron

/

13

Foglia Argento
Silver Leaf



10

Bianco
White

/

22

Foglia rame
Copper leaf



LOOP

SOLO LUCE DIRETTA
ONLY DIRECT LIGHT

CRI > 80

DIMMERABILE / DIMMABLE

Vai a pagina / Go to page 457

DIFFUSORE / DIFFUSER

Silicone opalino
Opaline-finish Silicone

*** ROSONE / CANOPY**

Informazioni Tecniche vai a pag. 455
Technical info go to page 455



Ø

54 Rosone da incasso
Recessed canopy
Max 3,2 Kg

2146/R35

Ø 45 mm

H 35 mm

Ø 35 mm

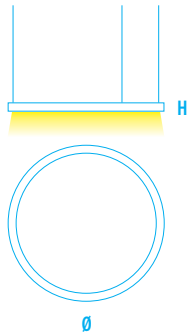

2129/S120-1

W 79 - Vdc 24

Lm 4.750

M 2.700°K - C 3.000°K

W 4.000°K

H 40 mm

L CAVI / CABLES 1.700 mm

Ø 1.200 mm

+

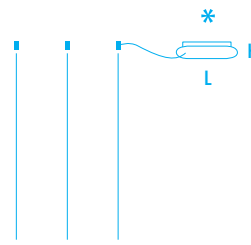

2129/R1-100

W 100 - Vac 230

H 45 mm

L 360x145 mm

DIMMERABILE / DIMMABLE

2129/R1-100 - D4

Taglio di fase / Phase Cut

2129/R1-100 - D6

1-10V - DALI - PUSH

2129/R1-100 - D7

ZigBee

2129/R1-100 - D8

CASAMBI

O/OR

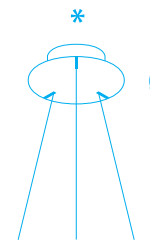

2129/R220-100

W 100 - Vac 230

H 45 mm

Ø 280 mm + Ø 220 mm

DIMMERABILE / DIMMABLE

2129/R220-100 - D4

Taglio di fase / Phase Cut

2129/R220-100 - D6

1-10V - DALI - PUSH

2129/R220-100 - D7

ZigBee

2129/R220-100 - D8

CASAMBI

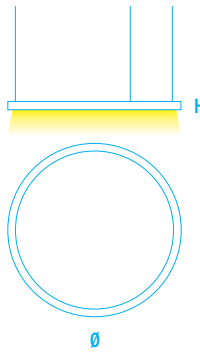

2129/S150-1

W 99 - Vdc 24

Lm 5.950

M 2.700°K - C 3.000°K

W 4.000°K

H 40 mm

L CAVI / CABLES 1.700 mm

Ø 1.500 mm

+

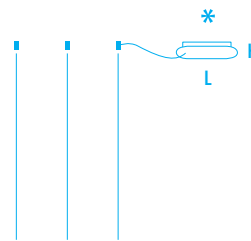

2129/R1-150

W 150 - Vac 230

H 45 mm

L 360x145 mm

DIMMERABILE / DIMMABLE

2129/R1-150 - D4

Taglio di fase / Phase Cut

2129/R1-150 - D6

1-10V - DALI - PUSH

2129/R1-150 - D7

ZigBee

2129/R1-150 - D8

CASAMBI

O/OR

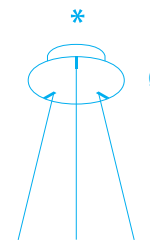

2129/R260-150

W 150 - Vac 230

H 45 mm

Ø 320 mm + Ø 260 mm

DIMMERABILE / DIMMABLE

2129/R260-150 - D4

Taglio di fase / Phase Cut

2129/R260-150 - D6

1-10V - DALI - PUSH

2129/R260-150 - D7

ZigBee

2129/R260-150 - D8

CASAMBI

10

Bianco
White



13

Foglia Argento
Silver Leaf



14

Foglia Oro
Gold Leaf



15

Grigio
Grey



19

Nero
Black



21

Grigio tortora
Dove grey



22

Foglia rame
Copper leaf



23

Ruggine
Rust



24

Ferro
Iron



28

Oro
Gold



29

Alluminio Spaz.
Brushed Alum.



30

Gunmetal



31

Rosé Spaz.
Brushed Rosé



32

Bronzo Spaz.
Brush. Bronze



33

Oro Spaz.
Brush. Gold



34

Rosé Verniciato
Painted Rosé



35

Bronzo Verniciato
Bronze Painted



BICOLORE / TWO-TONE

Vai a pagina / Go to page 454

19

Nero
Black

/

/

14

Foglia Oro
Gold Leaf



24

Ferro
Iron

/

/

13

Foglia Argento
Silver Leaf



10

Bianco
White

/

/

22

Foglia rame
Copper leaf





LOOP

LUCE DIRETTA + INDIRETTA
DIRECT + INDIRECT LIGHT

CRI > 80

DIMMERABILE / DIMMABLE

Vai a pagina / Go to page 457

DIFFUSORE / DIFFUSER

Silicone opalino
Opaline-finish Silicone

*** ROSONE / CANOPY**

Informazioni Tecniche vai a pag. 455
Technical info go to page 455

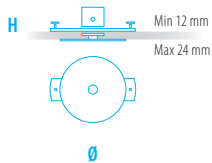

56 Rosone da incasso
Recessed canopy
Max 3,2 Kg

2146/R35

Ø 45 mm

H 35 mm

Ø 35 mm

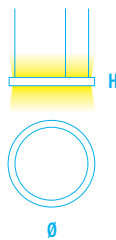

2129/S40-2

W 50 - Vdc 24

Lm 3.000

M 2.700°K - C 3.000°K

W 4.000°K

H 40 mm

L CAVI / CABLES 1.700 mm

Ø 400 mm

+

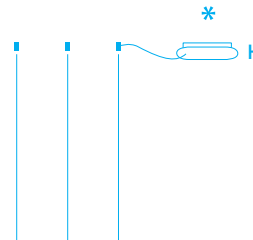

2129/R1-60

W 60 - Vac 230

H 45 mm

L 360x145 mm

DIMMERABILE / DIMMABLE

2129/R1-60 - D4

Taglio di fase / Phase Cut

2129/R1-60 - D6

1-10V - DALI - PUSH

2129/R1-60 - D7

ZigBee

2129/R1-60 - D8

CASAMBI

O/OR

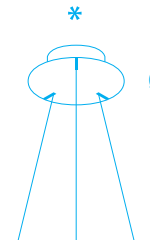

2129/R220-60

W 60 - Vac 230

H 45 mm

Ø 280 mm + Ø 220 mm

DIMMERABILE / DIMMABLE

2129/R220-60 - D4

Taglio di fase / Phase Cut

2129/R220-60 - D6

1-10V - DALI - PUSH

2129/R220-60 - D7

ZigBee

2129/R220-60 - D8

CASAMBI

10

Bianco
White



13

Foglia Argento
Silver Leaf



14

Foglia Oro
Gold Leaf



15

Grigio
Grey



19

Nero
Black



21

Grigio tortora
Dove grey



22

Foglia rame
Copper leaf



23

Ruggine
Rust



24

Ferro
Iron



28

Oro
Gold



29

Alluminio Spaz.
Brushed Alum.



30

Gunmetal



31

Rosé Spaz.
Brushed Rosé



32

Bronzo Spaz.
Brush. Bronze



33

Oro Spaz.
Brush. Gold



34

Rosé Verniciato
Painted Rosé



35

Bronzo Verniciato
Bronze Painted



BICOLORE / TWO-TONE

Vai a pagina / Go to page 454

19

Nero
Black

/

14

Foglia Oro
Gold Leaf



24

Ferro
Iron

/

13

Foglia Argento
Silver Leaf



10

Bianco
White

/

22

Foglia rame
Copper leaf







LOOP

LUCE DIRETTA + INDIRECTA
DIRECT + INDIRECT LIGHT

CRI > 80

DIMMERABILE / DIMMABLE

Vai a pagina / Go to page 457

DIFFUSORE / DIFFUSER

Silicone opalino
Opaline-finish Silicone

*** ROSONE / CANOPY**

Informazioni Tecniche vai a pag. 455
Technical info go to page 455



Ø

Rosone da incasso
Recessed canopy
Max 3,2 Kg

2146/R35

Ø 45 mm

H 35 mm

Ø 35 mm

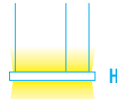

Ø

2129/S50-2

W 64 - Vdc 24

Lm 3.800

M 2.700°K - C 3.000°K

W 4.000°K

H 40 mm

L CAVI / CABLES 1.700 mm

Ø 500 mm

+

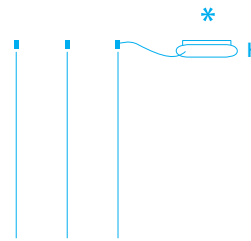

2129/R1-100

W 100 - Vac 230

H 45 mm

L 360x145 mm

DIMMERABILE / DIMMABLE

2129/R1-100 - D4

Taglio di fase / Phase Cut

2129/R1-100 - D6

1-10V - DALI - PUSH

2129/R1-100 - D7

ZigBee

2129/R1-100 - D8

CASAMBI

O/OR

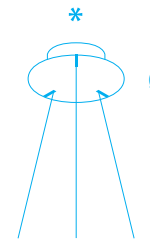

2129/R220-100

W 100 - Vac 230

H 45 mm

Ø 280 mm + Ø 220 mm

DIMMERABILE / DIMMABLE

2129/R220-100 - D4

Taglio di fase / Phase Cut

2129/R220-100 - D6

1-10V - DALI - PUSH

2129/R220-100 - D7

ZigBee

2129/R220-100 - D8

CASAMBI

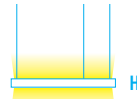

Ø

2129/S60-2

W 76 - Vdc 24

Lm 4.600

M 2.700°K - C 3.000°K

W 4.000°K

H 40 mm

L CAVI / CABLES 1.700 mm

Ø 600 mm

+

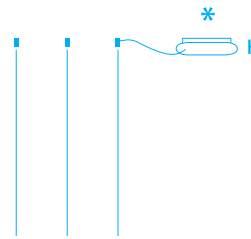

2129/R1-100

W 100 - Vac 230

H 45 mm

L 360x145 mm

DIMMERABILE / DIMMABLE

2129/R1-100 - D4

Taglio di fase / Phase Cut

2129/R1-100 - D6

1-10V - DALI - PUSH

2129/R1-100 - D7

ZigBee

2129/R1-100 - D8

CASAMBI

O/OR

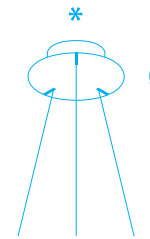

2129/R220-100

W 100 - Vac 230

H 45 mm

Ø 280 mm + Ø 220 mm

DIMMERABILE / DIMMABLE

2129/R220-100 - D4

Taglio di fase / Phase Cut

2129/R220-100 - D6

1-10V - DALI - PUSH

2129/R220-100 - D7

ZigBee

2129/R220-100 - D8

CASAMBI

10

Bianco
White



13

Foglia Argento
Silver Leaf



14

Foglia Oro
Gold Leaf



15

Grigio
Grey



19

Nero
Black



21

Grigio tortora
Dove grey



22

Foglia rame
Copper leaf



23

Ruggine
Rust



24

Ferro
Iron



28

Oro
Gold



29

Alluminio Spaz.
Brushed Alum.



30

Gunmetal



31

Rosé Spaz.
Brushed Rosé



32

Bronzo Spaz.
Brush. Bronze



33

Oro Spaz.
Brush. Gold



34

Rosé Verniciato
Painted Rosé



35

Bronzo Verniciato
Bronze Painted



BICOLORE / TWO-TONE

Vai a pagina / Go to page 454

19

Nero
Black

/

/

14

Foglia Oro
Gold Leaf



24

Ferro
Iron

/

/

13

Foglia Argento
Silver Leaf



10

Bianco
White

/

/

22

Foglia rame
Copper leaf





LOOP

LUCE DIRETTA + INDIRETTA
DIRECT + INDIRECT LIGHT

CRI > 80

DIMMERABILE / DIMMABLE

Vai a pagina / Go to page 457

DIFFUSORE / DIFFUSER

Silicone opalino
Opaline-finish Silicone

*** ROSONE / CANOPY**

Informazioni Tecniche vai a pag. 455
Technical info go to page 455



Rosone da incasso
Recessed canopy
Max 3,2 Kg

2146/R35

Ø 45 mm
H 35 mm
Ø 35 mm

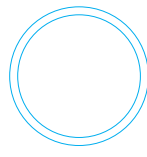
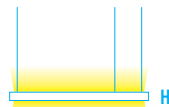

Ø
2129/S75-2

W 98 - Vdc 24

Lm 5.900
M 2.700°K - C 3.000°K
W 4.000°K

H 40 mm
L CAVI / CABLES 1.700 mm
Ø 750 mm

+

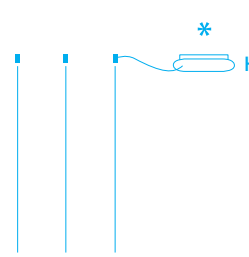

2129/R1-100

W 100 - Vac 230

H 45 mm
L 360x145 mm

DIMMERABILE / DIMMABLE

2129/R1-100 - D4

Taglio di fase / Phase Cut

2129/R1-100 - D6

1-10V - DALI - PUSH

2129/R1-100 - D7

ZigBee

2129/R1-100 - D8

CASAMBI

O/OR

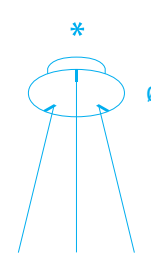

2129/R220-100

W 100 - Vac 230

H 45 mm
Ø 280 mm + Ø 220 mm

DIMMERABILE / DIMMABLE

2129/R220-100 - D4

Taglio di fase / Phase Cut

2129/R220-100 - D6

1-10V - DALI - PUSH

2129/R220-100 - D7

ZigBee

2129/R220-100 - D8

CASAMBI

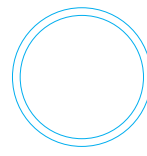
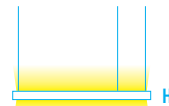

Ø
2129/S90-2

W 120 - Vdc 24

Lm 7.200
M 2.700°K - C 3.000°K
W 4.000°K

H 40 mm
L CAVI / CABLES 1.700 mm
Ø 900 mm

+

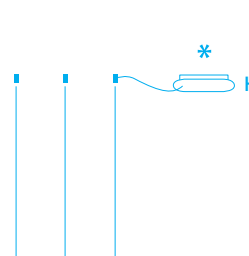

2129/R1-150

W 150 - Vac 230

H 45 mm
L 360x145 mm

DIMMERABILE / DIMMABLE

2129/R1-150 - D4

Taglio di fase / Phase Cut

2129/R1-150 - D6

1-10V - DALI - PUSH

2129/R1-150 - D7

ZigBee

2129/R1-150 - D8

CASAMBI

O/OR

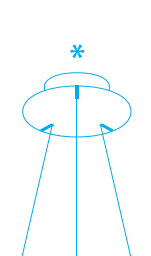

2129/R260-150

W 150 - Vac 230

H 45 mm
Ø 320 mm + Ø 260 mm

DIMMERABILE / DIMMABLE

2129/R260-150 - D4

Taglio di fase / Phase Cut

2129/R260-150 - D6

1-10V - DALI - PUSH

2129/R260-150 - D7

ZigBee

2129/R260-150 - D8

CASAMBI

10

Bianco
White



13

Foglia Argento
Silver Leaf



14

Foglia Oro
Gold Leaf



15

Grigio
Grey



19

Nero
Black



21

Grigio tortora
Dove grey



22

Foglia rame
Copper leaf



23

Ruggine
Rust



24

Ferro
Iron



28

Oro
Gold



29

Alluminio Spaz.
Brushed Alum.



30

Gunmetal



31

Rosé Spaz.
Brushed Rosé



32

Bronzo Spaz.
Brush. Bronze



33

Oro Spaz.
Brush. Gold



34

Rosé Verniciato
Painted Rosé



35

Bronzo Verniciato
Bronze Painted



BICOLORE / TWO-TONE

Vai a pagina / Go to page 454

19

Nero
Black

/

14

Foglia Oro
Gold Leaf



24

Ferro
Iron

/

13

Foglia Argento
Silver Leaf



10

Bianco
White

/

22

Foglia rame
Copper leaf



LOOP

LUCE DIRETTA + INDIRETTA
DIRECT + INDIRECT LIGHT

CRI > 80

DIMMERABILE / DIMMABLE

Vai a pagina / Go to page 457

DIFFUSORE / DIFFUSER

Silicone opalino
Opaline-finish Silicone

*** ROSONE / CANOPY**

Informazioni Tecniche vai a pag. 455
Technical info go to page 455

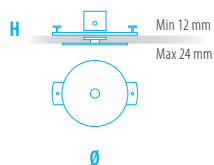

62 Rosone da incasso
Recessed canopy
Max 3,2 Kg

2146/R35

Ø 45 mm
H 35 mm
Ø 35 mm

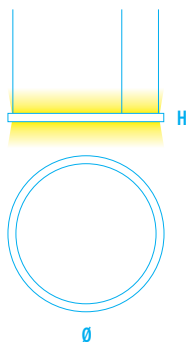

2129/S120-2

W 158 - Vdc 24
Lm 9.500
M 2.700°K - C 3.000°K
W 4.000°K
H 40 mm
L CAVI / CABLES 1.700 mm
Ø 1.200 mm

+

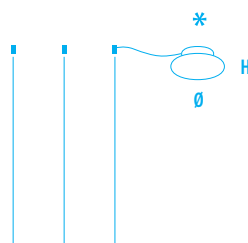

2129/R0-200

W 200 - Vac 230
H 45 mm
Ø 320 mm x Ø 260 mm

O/OR

DIMMERABILE / DIMMABLE

2129/R0-200 - D4
Taglio di fase / Phase Cut
2129/R0-200 - D6
1-10V - DALI - PUSH
2129/R0-200 - D7
ZigBee
2129/R0-200 - D8
CASAMBI

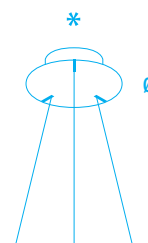

2129/R260-200

W 200 - Vac 230
H 50 mm
Ø 320 mm + Ø 260 mm

DIMMERABILE / DIMMABLE

2129/R260-200 - D4
Taglio di fase / Phase Cut
2129/R260-200 - D6
1-10V - DALI - PUSH
2129/R260-200 - D7
ZigBee
2129/R260-200 - D8
CASAMBI

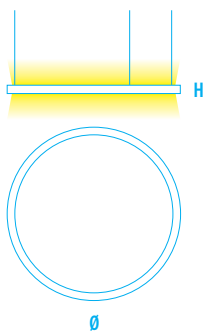

2129/S150-2

W 198 - Vdc 24
Lm 11.900
M 2.700°K - C 3.000°K
W 4.000°K
H 40 mm
L CAVI / CABLES 1.700 mm
Ø 1.500 mm

+

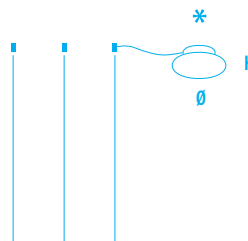

2129/R0-200

W 200 - Vac 230
H 50 mm
Ø 320 mm + Ø 260 mm

O/OR

DIMMERABILE / DIMMABLE

2129/R0-200 - D4
Taglio di fase / Phase Cut
2129/R0-200 - D6
1-10V - DALI - PUSH
2129/R0-200 - D7
ZigBee
2129/R0-200 - D8
CASAMBI

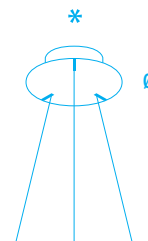

2129/R260-200

W 200 - Vac 230
H 50 mm
Ø 320 mm + Ø 260 mm

DIMMERABILE / DIMMABLE

2129/R260-200 - D4
Taglio di fase / Phase Cut
2129/R260-200 - D6
1-10V - DALI - PUSH
2129/R260-200 - D7
ZigBee
2129/R260-200 - D8
CASAMBI

10 Bianco
White



13 Foglia Argento
Silver Leaf



14 Foglia Oro
Gold Leaf



15 Grigio
Grey



19 Nero
Black



21 Grigio tortora
Dove grey



22 Foglia rame
Copper leaf



23 Ruggine
Rust



24 Ferro
Iron



28 Oro
Gold



29 Alluminio Spaz.
Brushed Alum.



30 Gunmetal



31 Rosé Spaz.
Brushed Rosé



32 Bronzo Spaz.
Brush. Bronze



33 Oro Spaz.
Brush. Gold



34 Rosé Verniciato
Painted Rosé



35 Bronzo Verniciato
Bronze Painted



BICOLORE / TWO-TONE

Vai a pagina / Go to page 454

19 Nero
Black
/

14 Foglia Oro
Gold Leaf



24 Ferro
Iron
/

13 Foglia Argento
Silver Leaf



10 Bianco
White
/

22 Foglia rame
Copper leaf







BRAGA LED

LOOP

ROSONE CON CARRUCOLE PER REGOLARE MANUALMENTE L'ALTEZZA DELLA LAMPADA CANOPY WITH ROLLS TO ADJUST MANUALLY PENDANT LAMP HEIGHT

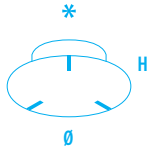

2129/R-S-G

H 50 mm
Ø 410 mm + Ø 350 mm

L CAVI / CABLES
Min. 700 mm
Max 2.600 mm

ON/OFF

- AL 30-24 (S40-1)
- AL 60-24 (S50-1 / S60-1 / S75-1 / S40-2)
- AL 100-24 (S90-1 / S120-1 / S50-2 / S60-2 / S75-2)
- AL 150-24 (S150-1 / S90-2)
- AL 200-24 (S120-2 / S150-2)

DIMMERABILE / DIMMABLE D4 (TAGLIO DI FASE/PHASE CUT)

- AL 50-24-D4 (S40-1 / S50-1 / S60-1)
- AL 75-24-D4 (S75-1 / S90-1 / S40-2 / S50-2)
- AL 100-24-D4 (S120-1 / S60-2 / S75-2)
- AL 200-24-D4 (S150-1 / S90-2 / S120-2 / S150-2)

DIMMERABILE / DIMMABLE D6 (1-10V-DALI-PUSH)

- AL 30-24-D6 (S40-1)
- AL 60-24-D6 (S50-1 / S60-1 / S75-1 / S40-2)
- AL 100-24-D6 (S90-1 / S120-1 / S50-2 / S60-2 / S75-2)
- AL 150-24-D6 (S150-1 / S90-2)
- AL 200-24-D6 (S120-2 / S150-2)

DIMMERABILE / DIMMABLE D7 (ZIGBEE)

- AL 30-24-D7 (S40-1)
- AL 60-24-D7 (S50-1 / S60-1 / S75-1 / S40-2)
- AL 100-24-D7 (S90-1 / S120-1 / S50-2 / S60-2 / S75-2)
- AL 150-24-D7 (S150-1 / S90-2)
- AL 200-24-D7 (S120-2 / S150-2)

DIMMERABILE / DIMMABLE D8 (CASAMBI)

- AL 30-24-D8 (S40-1)
- AL 60-24-D8 (S50-1 / S60-1 / S75-1 / S40-2)
- AL 100-24-D8 (S90-1 / S120-1 / S50-2 / S60-2 / S75-2)
- AL 150-24-D8 (S150-1 / S90-2)
- AL 200-24-D8 (S120-2 / S150-2)

* ROSONE / CANOPY

Informazioni Tecniche vai a pag. 455
Technical info go to page 455

| | | | | | |
|----------------------------------|-------------------------------------|-------------------------------|----------------------|---------------------------------------|---|
| 10 Bianco White | 13 Foglia Argento Silver Leaf | 14 Foglia Oro Gold Leaf | 15 Grigio Grey | 19 Nero Black | 21 Grigio tortora Dove grey |
| | | | | | |
| 22 Foglia rame Copper leaf | 23 Ruggine Rust | 24 Ferro Iron | 28 Oro Gold | 34 Rosè Verniciato Painted Rosè | 35 Bronzo Verniciato Bronze Painted |
| | | | | | |



LOOP

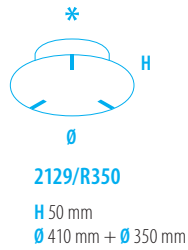
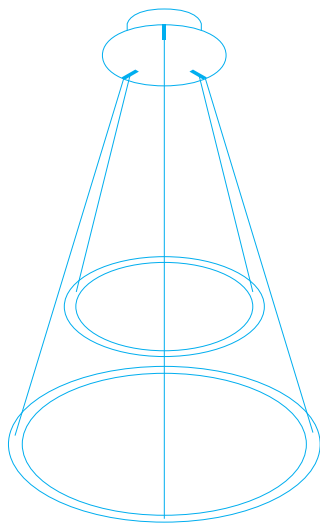

ESEMPIO D'ORDINE / EXAMPLE OF ORDER

- N.1 2129/S60-1 C10
- N.1 2129/S90-2 C10
- N.1 2129/R350 - 10
- N.1 AL 60-24
- N.1 AL 150-24

ON/OFF

- AL 30-24 (S40-1)
- AL 60-24 (S50-1 / S60-1 / S75-1 / S40-2)
- AL 100-24 (S90-1 / S120-1 / S50-2 / S60-2 / S75-2)
- AL 150-24 (S150-1 / S90-2)
- AL 200-24 (S120-2 / S150-2)

DIMMERABILE / DIMMABLE D4 (TAGLIO DI FASE/PHASE CUT)

- AL 50-24-D4 (S40-1 / S50-1 / S60-1)
- AL 75-24-D4 (S75-1 / S90-1 / S40-2 / S50-2)
- AL 100-24-D4 (S120-1 / S60-2 / S75-2)
- AL 200-24-D4 (S150-1 / S90-2 / S120-2 / S150-2)

DIMMERABILE / DIMMABLE D6 (1-10V-DALI-PUSH)

- AL 30-24-D6 (S40-1)
- AL 60-24-D6 (S50-1 / S60-1 / S75-1 / S40-2)
- AL 100-24-D6 (S90-1 / S120-1 / S50-2 / S60-2 / S75-2)
- AL 150-24-D6 (S150-1 / S90-2)
- AL 200-24-D6 (S120-2 / S150-2)

DIMMERABILE / DIMMABLE D7 (ZIGBEE)

- AL 30-24-D7 (S40-1)
- AL 60-24-D7 (S50-1 / S60-1 / S75-1 / S40-2)
- AL 100-24-D7 (S90-1 / S120-1 / S50-2 / S60-2 / S75-2)
- AL 150-24-D7 (S150-1 / S90-2)
- AL 200-24-D7 (S120-2 / S150-2)

DIMMERABILE / DIMMABLE D8 (CASAMBI)

- AL 30-24-D8 (S40-1)
- AL 60-24-D8 (S50-1 / S60-1 / S75-1 / S40-2)
- AL 100-24-D8 (S90-1 / S120-1 / S50-2 / S60-2 / S75-2)
- AL 150-24-D8 (S150-1 / S90-2)
- AL 200-24-D8 (S120-2 / S150-2)

* ROSONE / CANOPY

Informazioni Tecniche vai a pag. 455
Technical info go to page 455

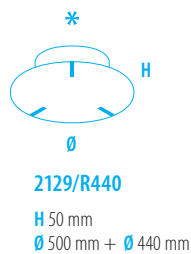
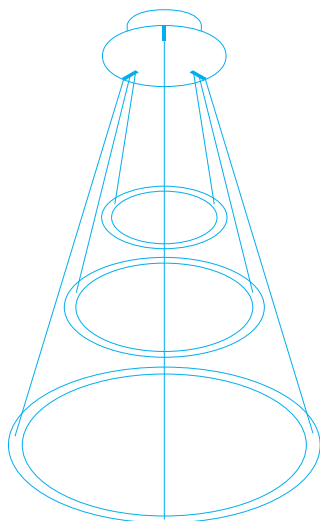

ESEMPIO D'ORDINE / EXAMPLE OF ORDER

- N.1 2129/S50-1 C19
- N.1 2129/S90-1 C19
- N.1 2129/S120-2 C19
- N.1 2129/R440-19
- N.1 AL 50-24 - D4
- N.1 AL 75-24 - D4
- N.1 AL 200-24 - D4

| | | | | | | | | |
|-----------------------|-------------------------------------|--|----------------------|----------------------------------|-------------------------------------|----------------------------------|---------------------------------------|---|
| 10 Bianco White | 13 Foglia Argento Silver Leaf | 14 Foglia Oro Gold Leaf | 15 Grigio Grey | 19 Nero Black | 21 Grigio tortora Dove grey | 22 Foglia rame Copper leaf | 23 Ruggine Rust | |
| 24 Ferro Iron | 28 Oro Gold | 29 Alluminio Spaz. Brushed Alum. | 30 Gunmetal | 31 Rosè Spaz. Brushed Rosè | 32 Bronzo Spaz. Brush. Bronze | 33 Oro Spaz. Brush. Gold | 34 Rosè Verniciato Painted Rosè | 35 Bronzo Verniciato Bronze Painted |

LOOP

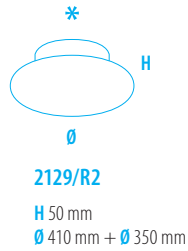
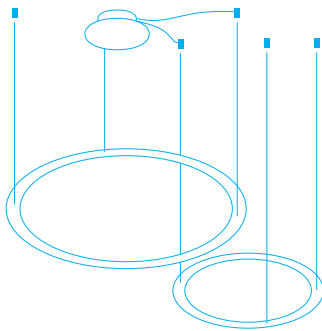

ESEMPIO D'ORDINE / EXAMPLE OF ORDER

- N.1 2129/S60-1 C10
- N.1 2129/S90-2 C10
- N.1 2129/R2-10
- N.1 AL 60-24
- N.1 AL 150-24

ON/OFF

- AL 30-24 (S40-1)
- AL 60-24 (S50-1 / S60-1 / S75-1 / S40-2)
- AL 100-24 (S90-1 / S120-1 / S50-2 / S60-2 / S75-2)
- AL 150-24 (S150-1 / S90-2)
- AL 200-24 (S120-2 / S150-2)

DIMMERABILE / DIMMABLE D4 (TAGLIO DI FASE/PHASE CUT)

- AL 50-24-D4 (S40-1 / S50-1 / S60-1)
- AL 75-24-D4 (S75-1 / S90-1 / S40-2 / S50-2)
- AL 100-24-D4 (S120-1 / S60-2 / S75-2)
- AL 200-24-D4 (S150-1 / S90-2 / S120-2 / S150-2)

DIMMERABILE / DIMMABLE D6 (1-10V-DALI-PUSH)

- AL 30-24-D6 (S40-1)
- AL 60-24-D6 (S50-1 / S60-1 / S75-1 / S40-2)
- AL 100-24-D6 (S90-1 / S120-1 / S50-2 / S60-2 / S75-2)
- AL 150-24-D6 (S150-1 / S90-2)
- AL 200-24-D6 (S120-2 / S150-2)

DIMMERABILE / DIMMABLE D7 (ZIGBEE)

- AL 30-24-D7 (S40-1)
- AL 60-24-D7 (S50-1 / S60-1 / S75-1 / S40-2)
- AL 100-24-D7 (S90-1 / S120-1 / S50-2 / S60-2 / S75-2)
- AL 150-24-D7 (S150-1 / S90-2)
- AL 200-24-D7 (S120-2 / S150-2)

DIMMERABILE / DIMMABLE D8 (CASAMBI)

- AL 30-24-D8 (S40-1)
- AL 60-24-D8 (S50-1 / S60-1 / S75-1 / S40-2)
- AL 100-24-D8 (S90-1 / S120-1 / S50-2 / S60-2 / S75-2)
- AL 150-24-D8 (S150-1 / S90-2)
- AL 200-24-D8 (S120-2 / S150-2)

* ROSONE / CANOPY

Informazioni Tecniche vai a pag. 455
Technical info go to page 455

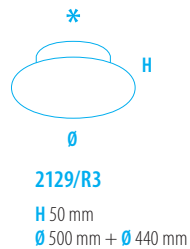
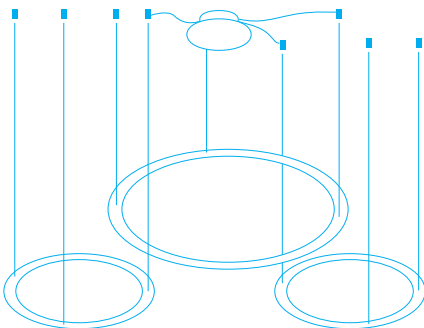

ESEMPIO D'ORDINE / EXAMPLE OF ORDER

- N.1 2129/S50-1 C19
- N.1 2129/S90-1 C19
- N.1 2129/S120-2 C19
- N.1 2129/R3-19
- N.1 AL 50-24 - D4
- N.1 AL 75-24 - D4
- N.1 AL 200-24 - D4

| | | | | | | | | |
|---|---|--|---|--|---|--|---|---|
| <p>10 Bianco White</p>  | <p>13 Foglia Argento Silver Leaf</p>  | <p>14 Foglia Oro Gold Leaf</p>  | <p>15 Grigio Grey</p>  | <p>19 Nero Black</p>  | <p>21 Grigio tortora Dove grey</p>  | <p>22 Foglia rame Copper leaf</p>  | <p>23 Ruggine Rust</p>  | |
| <p>24 Ferro Iron</p>  | <p>28 Oro Gold</p>  | <p>29 Alluminio Spaz. Brushed Alum.</p>  | <p>30 Gunmetal</p>  | <p>31 Rosé Spaz. Brushed Rosé</p>  | <p>32 Bronzo Spaz. Brush. Bronze</p>  | <p>33 Oro Spaz. Brush. Gold</p>  | <p>34 Rosè Verniciato Painted Rosè</p>  | <p>35 Bronzo Verniciato Bronze Painted</p>  |





LOOP

SOLO LUCE DIRETTA
ONLY DIRECT LIGHT

CRI > 80

DIMMERABILE / DIMMABLE

Vai a pagina / Go to page 457

DIFFUSORE / DIFFUSER

Silicone opalino
Opaline-finish Silicone

*** ROSONE / CANOPY**

Informazioni Tecniche vai a pag. 455
Technical info go to page 455

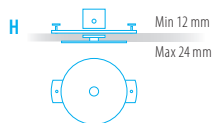

Ø

Rosone da incasso
Recessed canopy
Max 3,2 Kg

2146/R35

Ø 45 mm
H 35 mm
Ø 35 mm



Alimentatore Remoto
Remote Power Supply

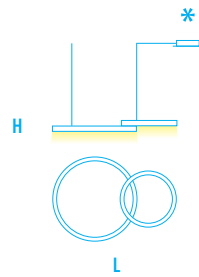

2128/S60-40-1

W 63 - Vac 230

Lm 3.800
M 2.700°K - C 3.000°K
W 4.000°K

H 80 mm
L 850x600 mm
L CAVI / CABLES 1.700 mm

DIMMERABILE / DIMMABLE

2128/S60-40-1 - D4
Taglio di fase / Phase Cut

2128/S60-40-1 - D6
1-10V - DALI - PUSH

2128/S60-40-1 - D7
ZigBee

2128/S60-40-1 - D8
CASAMBI

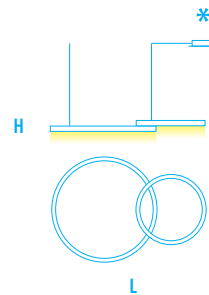

2128/S75-50-1

W 81 - Vac 230

Lm 4.850
M 2.700°K - C 3.000°K
W 4.000°K

H 80 mm
L 1.100x750 mm
L CAVI / CABLES 1.700 mm

DIMMERABILE / DIMMABLE

2128/S75-50-1 - D4
Taglio di fase / Phase Cut

2128/S75-50-1 - D6
1-10V - DALI - PUSH

2128/S75-50-1 - D7
ZigBee

2128/S75-50-1 - D8
CASAMBI

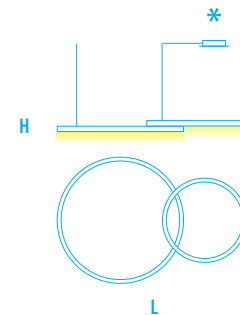

2128/S90-60-1

W 98 - Vac 230

Lm 5.900
M 2.700°K - C 3.000°K
W 4.000°K

H 80 mm
L 1.250x900 mm
L CAVI / CABLES 1.700 mm

DIMMERABILE / DIMMABLE

2128/S90-60-1 - D4
Taglio di fase / Phase Cut

2128/S90-60-1 - D6
1-10V - DALI - PUSH

2128/S90-60-1 - D7
ZigBee

2128/S90-60-1 - D8
CASAMBI

10
Bianco
White



13
Foglia Argento
Silver Leaf



14
Foglia Oro
Gold Leaf



15
Grigio
Grey



19
Nero
Black



21
Grigio tortora
Dove grey



22
Foglia rame
Copper leaf



23
Ruggine
Rust



24
Ferro
Iron



28
Oro
Gold



29
Alluminio Spaz.
Brushed Alum.



30
Gunmetal



31
Rosé Spaz.
Brushed Rosé



32
Bronzo Spaz.
Brush. Bronze



33
Oro Spaz.
Brush. Gold



34
Rosé Verniciato
Painted Rosé



35
Bronzo Verniciato
Bronze Painted



BICOLORE / TWO-TONE
Vai a pagina / Go to page 454

19
Nero
Black
/



24
Ferro
Iron
/



10
Bianco
White
/



14
Foglia Oro
Gold Leaf



13
Foglia Argento
Silver Leaf



22
Foglia rame
Copper leaf



LOOP

LUCE DIRETTA + INDIRETTA
DIRECT + INDIRECT LIGHT

CRI > 80

DIMMERABILE / DIMMABLE

Vai a pagina / Go to page 457

DIFFUSORE / DIFFUSER

Silicone opalino
Opaline-finish Silicone

*** ROSONE / CANOPY**

Informazioni Tecniche vai a pag. 455
Technical info go to page 455



Ø

72 Rosone da incasso
Recessed canopy
Max 3,2 Kg

2146/R35

Ø 45 mm

H 35 mm

Ø 35 mm



Alimentatore Remoto
Remote Power Supply

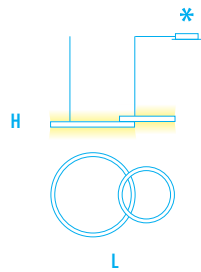

2128/S60-40-2

W 126 - Vac 230

Lm 7.600

M 2.700°K - C 3.000°K

W 4.000°K

H 80 mm

L 850x600 mm

L CAVI / CABLES 1.700 mm

DIMMERABILE / DIMMABLE

2128/S60-40-2 - D4
Taglio di fase / Phase Cut

2128/S60-40-2 - D6
1-10V - DALI - PUSH

2128/S60-40-2 - D7
ZigBee

2128/S60-40-2 - D8
CASAMBI

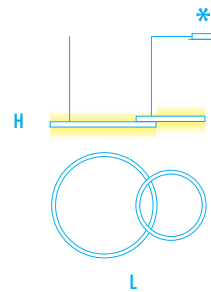

2128/S75-50-2

W 162 - Vac 230

Lm 9.700

M 2.700°K - C 3.000°K

W 4.000°K

H 80 mm

L 1.100x750 mm

L CAVI / CABLES 1.700 mm

DIMMERABILE / DIMMABLE

2128/S75-50-2 - D4
Taglio di fase / Phase Cut

2128/S75-50-2 - D6
1-10V - DALI - PUSH

2128/S75-50-2 - D7
ZigBee

2128/S75-50-2 - D8
CASAMBI

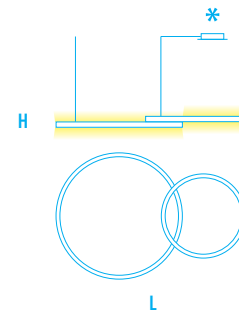

2128/S90-60-2

W 196 - Vac 230

Lm 11.800

M 2.700°K - C 3.000°K

W 4.000°K

H 80 mm

L 1.250x900 mm

L CAVI / CABLES 1.700 mm

DIMMERABILE / DIMMABLE

2128/S90-60-2 - D4
Taglio di fase / Phase Cut

2128/S90-60-2 - D6
1-10V - DALI - PUSH

2128/S90-60-2 - D7
ZigBee

2128/S90-60-2 - D8
CASAMBI

10 Bianco
White



13 Foglia Argento
Silver Leaf



14 Foglia Oro
Gold Leaf



15 Grigio
Grey



19 Nero
Black



21 Grigio tortora
Dove grey



22 Foglia rame
Copper leaf



23 Ruggine
Rust



24 Ferro
Iron



28 Oro
Gold



29 Alluminio Spaz.
Brushed Alum.



30 Gunmetal



31 Rosé Spaz.
Brushed Rosé



32 Bronzo Spaz.
Brush. Bronze



33 Oro Spaz.
Brush. Gold



34 Rosé Verniciato
Painted Rosé



35 Bronzo Verniciato
Bronze Painted



BICOLORE / TWO-TONE

Vai a pagina / Go to page 454

19 Nero
Black

/

14 Foglia Oro
Gold Leaf



24 Ferro
Iron

/

13 Foglia Argento
Silver Leaf



10 Bianco
White

/

22 Foglia rame
Copper leaf







74

LOOP

LUCE DIRETTA + INDIRETTA
DIRECT + INDIRECT LIGHT

CRI > 80

DIMMERABILE / DIMMABLE

Vai a pagina / Go to page 457

DIFFUSORE / DIFFUSER

Silicone opalino
Opaline-finish Silicone

*** ROSONE / CANOPY**

Informazioni Tecniche vai a pag. 455
Technical info go to page 455

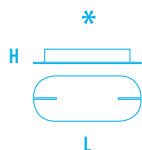

H 45 mm
L 360 x 145 mm

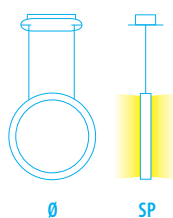

2134/S50-2

W 64 - Vac 230

Lm 3.800

M 2.700°K - C 3.000°K

W 4.000°K

SP 40 mm

L CAVI / CABLES 1.700 mm

Ø 500 mm

DIMMERABILE / DIMMABLE

2134/S50-2 - D4

Taglio di fase / Phase Cut

2134/S50-2 - D6

1-10V - DALI - PUSH

2134/S50-2 - D7

ZigBee

2134/S50-2 - D8

CASAMBI

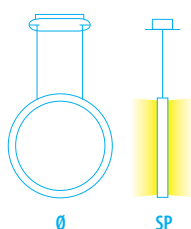

2134/S60-2

W 76 - Vac 230

Lm 4.600

M 2.700°K - C 3.000°K

W 4.000°K

SP 40 mm

L CAVI / CABLES 1.700 mm

Ø 600 mm

DIMMERABILE / DIMMABLE

2134/S60-2 - D4

Taglio di fase / Phase Cut

2134/S60-2 - D6

1-10V - DALI - PUSH

2134/S60-2 - D7

ZigBee

2134/S60-2 - D8

CASAMBI

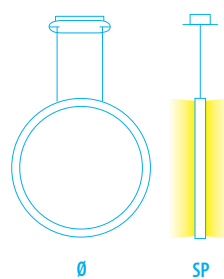

2134/S75-2

W 98 - Vac 230

Lm 5.900

M 2.700°K - C 3.000°K

W 4.000°K

SP 40 mm

L CAVI / CABLES 1.700 mm

Ø 750 mm

DIMMERABILE / DIMMABLE

2134/S75-2 - D4

Taglio di fase / Phase Cut

2134/S75-2 - D6

1-10V - DALI - PUSH

2134/S75-2 - D7

ZigBee

2134/S75-2 - D8

CASAMBI

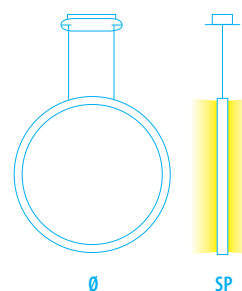

2134/S90-2

W 120 - Vac 230

Lm 7.200

M 2.700°K - C 3.000°K

W 4.000°K

SP 40 mm

L CAVI / CABLES 1.700 mm

Ø 900 mm

DIMMERABILE / DIMMABLE

2134/S90-2 - D4

Taglio di fase / Phase Cut

2134/S90-2 - D6

1-10V - DALI - PUSH

2134/S90-2 - D7

ZigBee

2134/S90-2 - D8

CASAMBI

75

10
Bianco
White



13
Foglia Argento
Silver Leaf



14
Foglia Oro
Gold Leaf



15
Grigio
Grey



19
Nero
Black



21
Grigio tortora
Dove grey



22
Foglia rame
Copper leaf



23
Ruggine
Rust



24
Ferro
Iron



28
Oro
Gold



29
Alluminio Spaz.
Brushed Alum.



30
Gunmetal



31
Rosé Spaz.
Brushed Rosé



32
Bronzo Spaz.
Brush. Bronze



33
Oro Spaz.
Brush. Gold



34
Rosé Verniciato
Painted Rosé



35
Bronzo Verniciato
Bronze Painted



BICOLORE / TWO-TONE

Vai a pagina / Go to page 454

19
Nero
Black



24
Ferro
Iron



10
Bianco
White



14
Foglia Oro
Gold Leaf



13
Foglia Argento
Silver Leaf



22
Foglia rame
Copper leaf



LOOP

SOLO LUCE DIRETTA
ONLY DIRECT LIGHT

CRI > 80

DIMMERABILE / DIMMABLE

Vai a pagina / Go to page 457

DIFFUSORE / DIFFUSER

Silicone opalino
Opaline-finish Silicone

*** ROSONE / CANOPY**

Informazioni Tecniche vai a pag. 455
Technical info go to page 455

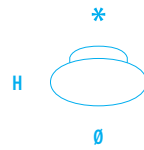

2133/R

Rosone con Alimentatore 75W
Base whit Power Supply 75W

H 30 mm
Ø 220 mm + Ø 190 mm

DIMMERABILE / DIMMABLE

2133/R - D4

Taglio di fase / Phase Cut

2133/R - D6

1-10V - DALI - PUSH

2133/R - D8

CASAMBI

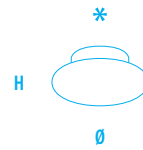

2129/R220-0-150

Rosone con Alimentatore 150W
Base whit Power Supply 150W

H 45 mm
Ø 280 mm + Ø 220 mm

DIMMERABILE / DIMMABLE

2129/R220-0-150 - D4

Taglio di fase / Phase Cut

2129/R220-0-150 - D6

1-10V - DALI - PUSH

2129/R220-0-150 - D8

CASAMBI

76

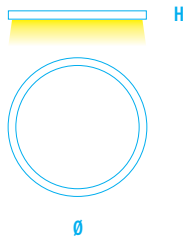

2129/TR90

W 60 - Vdc 24

Lm 3.600
M 2.700°K
C 3.000°K - W 4.000°K

H 45 mm
Ø 900 mm

ALIMENTATORE REMOTO
REMOTE POWER SUPPLY

ON/OFF
AL. 100-24

DIMMERABILE / DIMMABLE

AL.75-24 - D4

Taglio di fase / Phase Cut

AL.100-24 - D6

1-10V - DALI - PUSH

AL.100-24 - D7

ZigBee

AL.100-24 - D8

CASAMBI

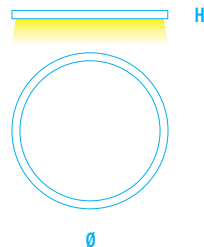

2129/TR120

W 79 - Vdc 24

Lm 4.750
M 2.700°K
C 3.000°K - W 4.000°K

H 45 mm
Ø 1200 mm

ALIMENTATORE REMOTO
REMOTE POWER SUPPLY

ON/OFF
AL. 100-24

DIMMERABILE / DIMMABLE

AL.100-24 - D4

Taglio di fase / Phase Cut

AL.100-24 - D6

1-10V - DALI - PUSH

AL.100-24 - D7

ZigBee

AL.100-24 - D8

CASAMBI

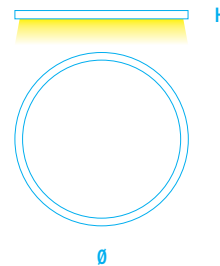

2129/TR150

W 99 - Vdc 24

Lm 5.950
M 2.700°K
C 3.000°K - W 4.000°K

H 45 mm
Ø 1500 mm

ALIMENTATORE REMOTO
REMOTE POWER SUPPLY

ON/OFF
AL. 150-24

DIMMERABILE / DIMMABLE

AL.200-24 - D4

Taglio di fase / Phase Cut

AL.150-24 - D6

1-10V - DALI - PUSH

AL.150-24 - D7

ZigBee

AL.150-24 - D8

CASAMBI

10
Bianco
White



13
Foglia Argento
Silver Leaf



14
Foglia Oro
Gold Leaf



15
Grigio
Grey



19
Nero
Black



21
Grigio tortora
Dove grey



22
Foglia rame
Copper leaf



23
Ruggine
Rust



24
Ferro
Iron



28
Oro
Gold



29
Alluminio Spaz.
Brushed Alum.



30
Gunmetal



31
Rosé Spaz.
Brushed Rosé



32
Bronzo Spaz.
Brush. Bronze



33
Oro Spaz.
Brush. Gold



34
Rosé Verniciato
Painted Rosé



35
Bronzo Verniciato
Bronze Painted



BICOLORE / TWO-TONE

Vai a pagina / Go to page 454

19
Nero
Black

24
Ferro
Iron



10
Bianco
White

13
Foglia Argento
Silver Leaf



14
Foglia Oro
Gold Leaf

22
Foglia rame
Copper leaf





78

2129/TR75 - TR50 + 2133/R

BRAGA LED

LOOP

SOLO LUCE DIRETTA
ONLY DIRECT LIGHT

CRI > 80

DIMMERABILE / DIMMABLE

Vai a pagina / Go to page 457

DIFFUSORE / DIFFUSER

Silicone opalino
Opaline-finish Silicone

*** ROSONE / CANOPY**

Informazioni Tecniche vai a pag. 455
Technical info go to page 455

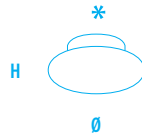

2133/R

Rosone con Alimentatore 75W
Base whit Power Supply 75W

H 30 mm
Ø 220 mm + Ø 190 mm

DIMMERABILE / DIMMABLE

2133/R - D4

Taglio di fase / Phase Cut

2133/R - D6

1-10V - DALI - PUSH

2133/R - D8

CASAMBI

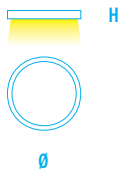

2129/TR40

W 25 - Vdc 24

Lm 1.500
M 2.700°K
C 3.000°K - W 4.000°K

H 45 mm
Ø 400 mm

ALIMENTATORE REMOTO
REMOTE POWER SUPPLY

ON/OFF
AL. 30-24

DIMMERABILE / DIMMABLE

AL. 30-24 - D4

Taglio di fase / Phase Cut

AL. 30-24 - D6

1-10V - DALI - PUSH

AL. 30-24 - D7

ZigBee

AL. 30-24 - D8

CASAMBI



2129/TR50

W 32 - Vdc 24

Lm 1.900
M 2.700°K
C 3.000°K - W 4.000°K

H 45 mm
Ø 500 mm

ALIMENTATORE REMOTO
REMOTE POWER SUPPLY

ON/OFF
AL. 60-24

DIMMERABILE / DIMMABLE

AL. 50-24 - D4

Taglio di fase / Phase Cut

AL. 60-24 - D6

1-10V - DALI - PUSH

AL. 60-24 - D7

ZigBee

AL. 60-24 - D8

CASAMBI

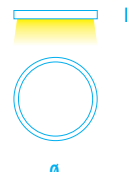

2129/TR60

W 38 - Vdc 24

Lm 2.300
M 2.700°K
C 3.000°K - W 4.000°K

H 45 mm
Ø 600 mm

ALIMENTATORE REMOTO
REMOTE POWER SUPPLY

ON/OFF
AL. 60-24

DIMMERABILE / DIMMABLE

AL. 50-24 - D4

Taglio di fase / Phase Cut

AL. 60-24 - D6

1-10V - DALI - PUSH

AL. 60-24 - D7

ZigBee

AL. 60-24 - D8

CASAMBI

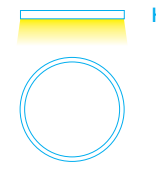

2129/TR75

W 49 - Vdc 24

Lm 2.950
M 2.700°K
C 3.000°K - W 4.000°K

H 45 mm
Ø 750 mm

ALIMENTATORE REMOTO
REMOTE POWER SUPPLY

ON/OFF
AL. 60-24

DIMMERABILE / DIMMABLE

AL. 75-24 - D4

Taglio di fase / Phase Cut

AL. 60-24 - D6

1-10V - DALI - PUSH

AL. 60-24 - D7

ZigBee

AL. 60-24 - D8

CASAMBI

10
Bianco
White



13
Foglia Argento
Silver Leaf



14
Foglia Oro
Gold Leaf



15
Grigio
Grey



19
Nero
Black



21
Grigio tortora
Dove grey



22
Foglia rame
Copper leaf



23
Ruggine
Rust



24
Ferro
Iron



28
Oro
Gold



29
Alluminio Spaz.
Brushed Alum.



30
Gunmetal



31
Rosé Spaz.
Brushed Rosé



32
Bronzo Spaz.
Brush. Bronze



33
Oro Spaz.
Brush. Gold



34
Rosé Verniciato
Painted Rosé



35
Bronzo Verniciato
Bronze Painted



BICOLORE / TWO-TONE

Vai a pagina / Go to page 454

19
Nero
Black



24
Ferro
Iron



10
Bianco
White



14
Foglia Oro
Gold Leaf



13
Foglia Argento
Silver Leaf



22
Foglia rame
Copper leaf





LOOP

SOLO LUCE DIRETTA
ONLY DIRECT LIGHT

CRI > 80

DIMMERABILE / DIMMABLE

Vai a pagina / Go to page 457

DIFFUSORE / DIFFUSER

Silicone opalino
Opaline-finish Silicone

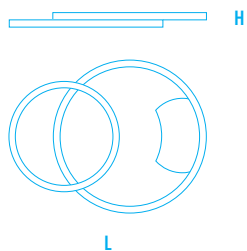

2129/PL2

W 63 - Vac 230

Lm 3.800

M 2.700°K

C 3.000°K - W 4.000°K

L 600 x 750 mm

H 80 mm

DIMMERABILE / DIMMABLE

2129/PL2 - D4

Taglio di fase / Phase Cut

2129/PL2 - D6

1-10V - DALI - PUSH

2129/PL2 - D8

CASAMBI

10

Bianco
White



13

Foglia Argento
Silver Leaf



14

Foglia Oro
Gold Leaf



15

Grigio
Grey



19

Nero
Black



21

Grigio tortora
Dove grey



22

Foglia rame
Copper leaf



23

Ruggine
Rust



24

Ferro
Iron



28

Oro
Gold



34

Rosè Verniciato
Painted Rosè



35

Bronzo Verniciato
Bronze Painted







LOOP

SOLO LUCE DIRETTA
ONLY DIRECT LIGHT

CRI > 80

DIMMERABILE / DIMMABLE

Vai a pagina / Go to page 457

DIFFUSORE / DIFFUSER

Silicone opalino
Opaline-finish Silicone

84

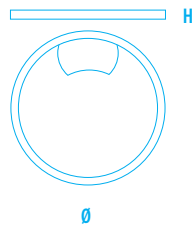

2129/PL60

W 38 - Vac 230

Lm 2.300

M 2.700°K

C 3.000°K - W 4.000°K

Ø 600 mm

H 40 mm

DIMMERABILE / DIMMABLE

2129/PL60 - D4

Taglio di fase / Phase Cut

2129/PL60 - D6

1-10V - DALI - PUSH

2129/PL60 - D8

CASAMBI

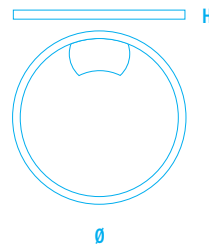

2129/PL75

W 49 - Vac 230

Lm 2.950

M 2.700°K

C 3.000°K - W 4.000°K

Ø 750 mm

H 40 mm

DIMMERABILE / DIMMABLE

2129/PL75 - D4

Taglio di fase / Phase Cut

2129/PL75 - D6

1-10V - DALI - PUSH

2129/PL75 - D8

CASAMBI

10

Bianco
White



13

Foglia Argento
Silver Leaf



14

Foglia Oro
Gold Leaf



15

Grigio
Grey



19

Nero
Black



21

Grigio tortora
Dove grey



22

Foglia rame
Copper leaf



23

Ruggine
Rust



24

Ferro
Iron



28

Oro
Gold



34

Rosè Verniciato
Painted Rosè



35

Bronzo Verniciato
Bronze Painted





LOOP

LUCE DIRETTA + INDIRETTA
DIRECT + INDIRECT LIGHT

CRI > 80

DIMMERABILE / DIMMABLE

Vai a pagina / Go to page 457

DIFFUSORE / DIFFUSER

Silicone opalino
Opaline-finish Silicone

*** ROSONE / CANOPY**

Informazioni Tecniche vai a pag. 455
Technical info go to page 453



86

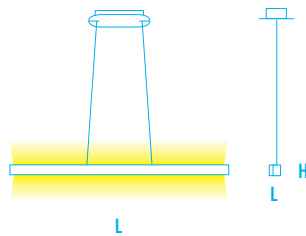

2129/S1

W 57 - Vac 230

Lm 3.400

M 2.700°K

C 3.000°K - W 4.000°K

L 1.360 mm

L 20 mm

H 40 mm

L CAVI / CABLES 1.700 mm

DIMMERABILE / DIMMABLE

2129/S1 - D4

Taglio di fase / Phase Cut

2129/S1 - D6

1-10V - DALI - PUSH

2129/S1 - D7

ZigBee

2129/S1 - D8

CASAMBI

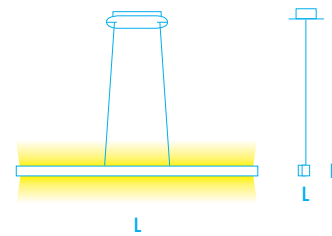

2129/S2

W 65 - Vac 230

Lm 3.900

M 2.700°K

C 3.000°K - W 4.000°K

L 1.610 mm

L 20 mm

H 40 mm

L CAVI / CABLES 1.700 mm

DIMMERABILE / DIMMABLE

2129/S2 - D4

Taglio di fase / Phase Cut

2129/S2 - D6

1-10V - DALI - PUSH

2129/S2 - D7

ZigBee

2129/S2 - D8

CASAMBI

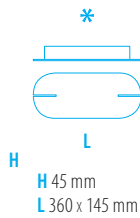

10

Bianco
White



13

Foglia Argento
Silver Leaf



14

Foglia Oro
Gold Leaf



15

Grigio
Grey



19

Nero
Black



21

Grigio tortora
Dove grey



22

Foglia rame
Copper leaf



23

Ruggine
Rust



24

Ferro
Iron



28

Oro
Gold



29

Alluminio Spaz.
Brushed Alum.



30

Gunmetal



31

Rosè Spaz.
Brushed Rosè



32

Bronzo Spaz.
Brush. Bronze



33

Oro Spaz.
Brush. Gold



34

Rosè Verniciato
Painted Rosè



35

Bronzo Verniciato
Bronze Painted





LOOP

CRI > 80

DIFFUSORE / DIFFUSER

Silicone opalino
Opaline-finish Silicone

88



2129/T

W 57 - Vac 230

Lm 3.400

M 2.700°K

C 3.000°K - W 4.000°K

H 1.950 mm

L 40 mm

BASE 260 x 260 mm

TOUCH DIMMER

10

Bianco
White



13

Foglia Argento
Silver Leaf



14

Foglia Oro
Gold Leaf



15

Grigio
Grey



19

Nero
Black



21

Grigio tortora
Dove grey



22

Foglia rame
Copper leaf



23

Ruggine
Rust



24

Ferro
Iron



28

Oro
Gold



34

Rosè Verniciato
Painted Rosè



35

Bronzo Verniciato
Bronze Painted







LOOP

CRI > 80

DIMMERABILE / DIMMABLE

Vai a pagina / Go to page 457

DIFFUSORE / DIFFUSER

Silicone opalino
Opaline-finish Silicone

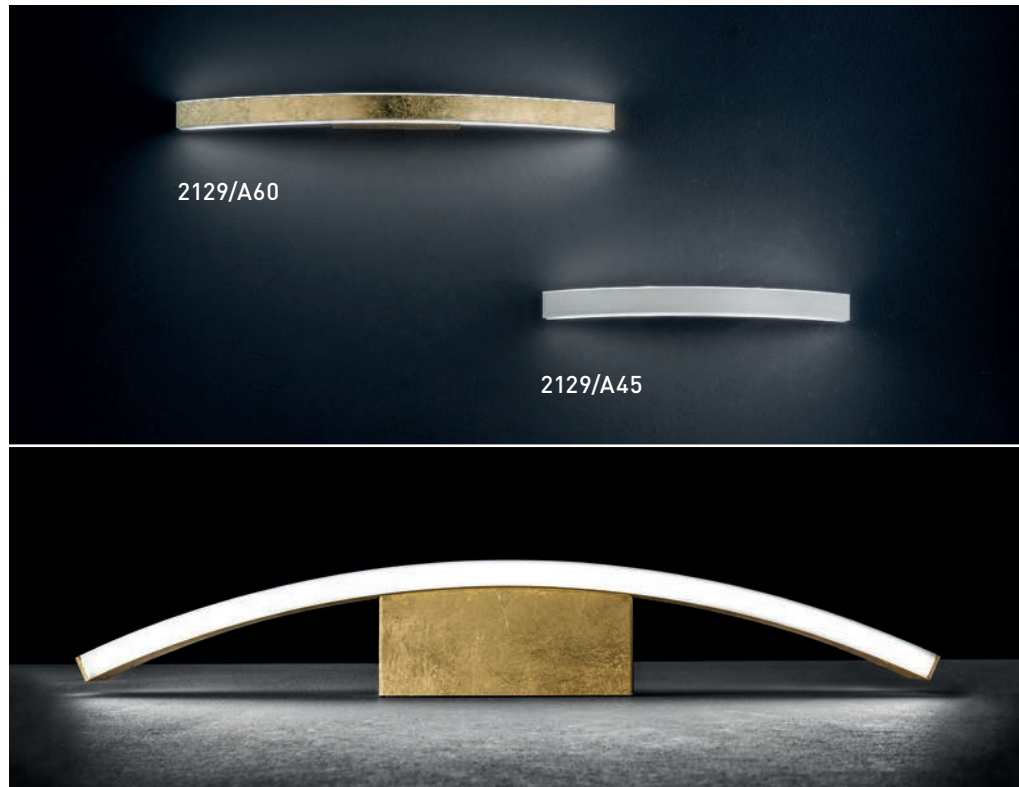

91

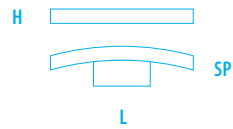

2129/A45

W 27 - Vac 230

Lm 1.600

M 2.700°K

C 3.000°K - W 4.000°K

L 520 mm

H 40 mm

SP 100 mm

DIMMERABILE / DIMMABLE

2129/A45 - D4

Taglio di fase / Phase Cut

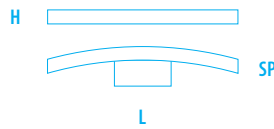

2129/A60

W 40 - Vac 230

Lm 2.400

M 2.700°K

C 3.000°K - W 4.000°K

L 680 mm

H 40 mm

SP 110 mm

DIMMERABILE / DIMMABLE

2129/A60 - D4

Taglio di fase / Phase Cut

10
Bianco
White



13
Foglia Argento
Silver Leaf



14
Foglia Oro
Gold Leaf



15
Grigio
Grey



19
Nero
Black



21
Grigio tortora
Dove grey



22
Foglia rame
Copper leaf



23
Ruggine
Rust



24
Ferro
Iron



28
Oro
Gold



29
Alluminio Spaz.
Brushed Alum.



30
Gunmetal



31
Rosé Spaz.
Brushed Rosé



32
Bronzo Spaz.
Brush. Bronze



33
Oro Spaz.
Brush. Gold



34
Rosé Verniciato
Painted Rosé



35
Bronzo Verniciato
Bronze Painted



Spira

92







SPIRA

CRI > 80

DIMMERABILE / DIMMABLE

Vai a pagina / Go to page 457

DIFFUSORE / DIFFUSER

Silicone opalino
Opaline-finish Silicone

*** ROSONE / CANOPY**

Informazioni Tecniche vai a pag. 455
Technical info go to page 455

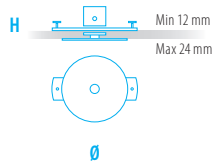

Rosone da incasso
Recessed canopy
Max 3,2 Kg

2146/R35

Ø 45 mm
H 35 mm
Ø 35 mm



Alimentatore Remoto
Remote Power Supply

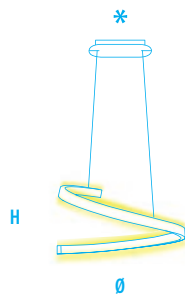

2130/S60

W 79 - Vac 230

Lm 4.750
M 2.700°K
C 3.000°K - W 4.000°K

Ø 600 mm
H 400 mm
L CAVI / CABLES 1.700 mm

DIMMERABILE / DIMMABLE

2130/S60 - D4
Taglio di fase / Phase Cut

2130/S60 - D6
1-10V - DALI - PUSH

2130/S60 - D7
ZigBee

2130/S60 - D8
CASAMBI

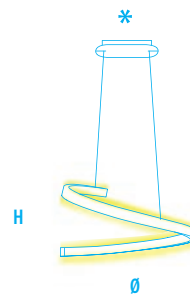

2130/S75

W 101 - Vac 230

Lm 6.050
M 2.700°K
C 3.000°K - W 4.000°K

Ø 750 mm
H 400 mm
L CAVI / CABLES 1.700 mm

DIMMERABILE / DIMMABLE

2130/S75 - D4
Taglio di fase / Phase Cut

2130/S75 - D6
1-10V - DALI - PUSH

2130/S75 - D7
ZigBee

2130/S75 - D8
CASAMBI

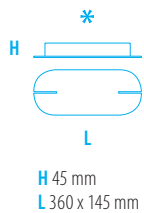

H 45 mm
L 360 x 145 mm

| | | | | | |
|---|--|--------------------------------------|-----------------------------|--|--|
| 10 Bianco White | 13 Foglia Argento Silver Leaf | 14 Foglia Oro Gold Leaf | 15 Grigio Grey | 19 Nero Black | 21 Grigio tortora Dove grey |
| 22 Foglia rame Copper leaf | 23 Ruggine Rust | 24 Ferro Iron | 28 Oro Gold | 34 Rosè Verniciato Painted Rosè | 35 Bronzo Verniciato Bronze Painted |

BICOLORE / TWO-TONE

Vai a pagina / Go to page 454

| | | |
|--------------------------------------|--|---|
| 19 Nero Black / | 24 Ferro Iron / | 10 Bianco White / |
| 14 Foglia Oro Gold Leaf | 13 Foglia Argento Silver Leaf | 22 Foglia rame Copper leaf |

SPIRA

CRI > 80

DIMMERABILE / DIMMABLE

Vai a pagina / Go to page 457

DIFFUSORE / DIFFUSER

Silicone opalino
Opaline-finish Silicone

*** ROSONE / CANOPY**

Informazioni Tecniche vai a pag. 455
Technical info go to page 455

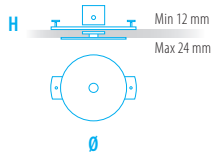

Rosone da incasso
Recessed canopy
Max 3,2 Kg

96

2146/R35

Ø 45 mm

H 35 mm

Ø 35 mm



Alimentatore Remoto
Remote Power Supply

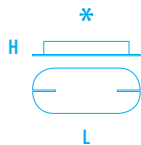

H 45 mm

L 360 x 145 mm

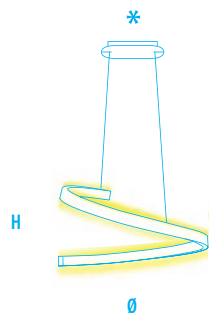

2130/S90

W 123 - Vac 230

Lm 7.400

M 2.700°K

C 3.000°K - W 4.000°K

Ø 900 mm

H 400 mm

L CAVI / CABLES 1.700 mm

DIMMERABILE / DIMMABLE

2130/S90 - D4

Taglio di fase / Phase Cut

2130/S90 - D6

1-10V - DALI - PUSH

2130/S90 - D7

ZigBee

2130/S90 - D8

CASAMBI

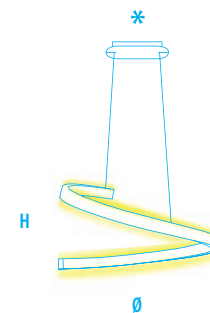

2130/S110

W 159 - Vac 230

Lm 9.500

M 2.700°K

C 3.000°K - W 4.000°K

Ø 1.100 mm

H 400 mm

L CAVI / CABLES 1.700 mm

DIMMERABILE / DIMMABLE

2130/S110 - D4

Taglio di fase / Phase Cut

2130/S110 - D6

1-10V - DALI - PUSH

2130/S110 - D7

ZigBee

2130/S110 - D8

CASAMBI

10
Bianco
White



13
Foglia Argento
Silver Leaf



14
Foglia Oro
Gold Leaf



15
Grigio
Grey



19
Nero
Black



21
Grigio tortora
Dove grey



22
Foglia rame
Copper leaf



23
Ruggine
Rust



24
Ferro
Iron



28
Oro
Gold



34
Rosè Verniciato
Painted Rosè



35
Bronzo Verniciato
Bronze Painted



BICOLORE / TWO-TONE

Vai a pagina / Go to page 454

19
Nero
Black
/

14
Foglia Oro
Gold Leaf



24
Ferro
Iron
/

13
Foglia Argento
Silver Leaf



10
Bianco
White
/

22
Foglia rame
Copper leaf



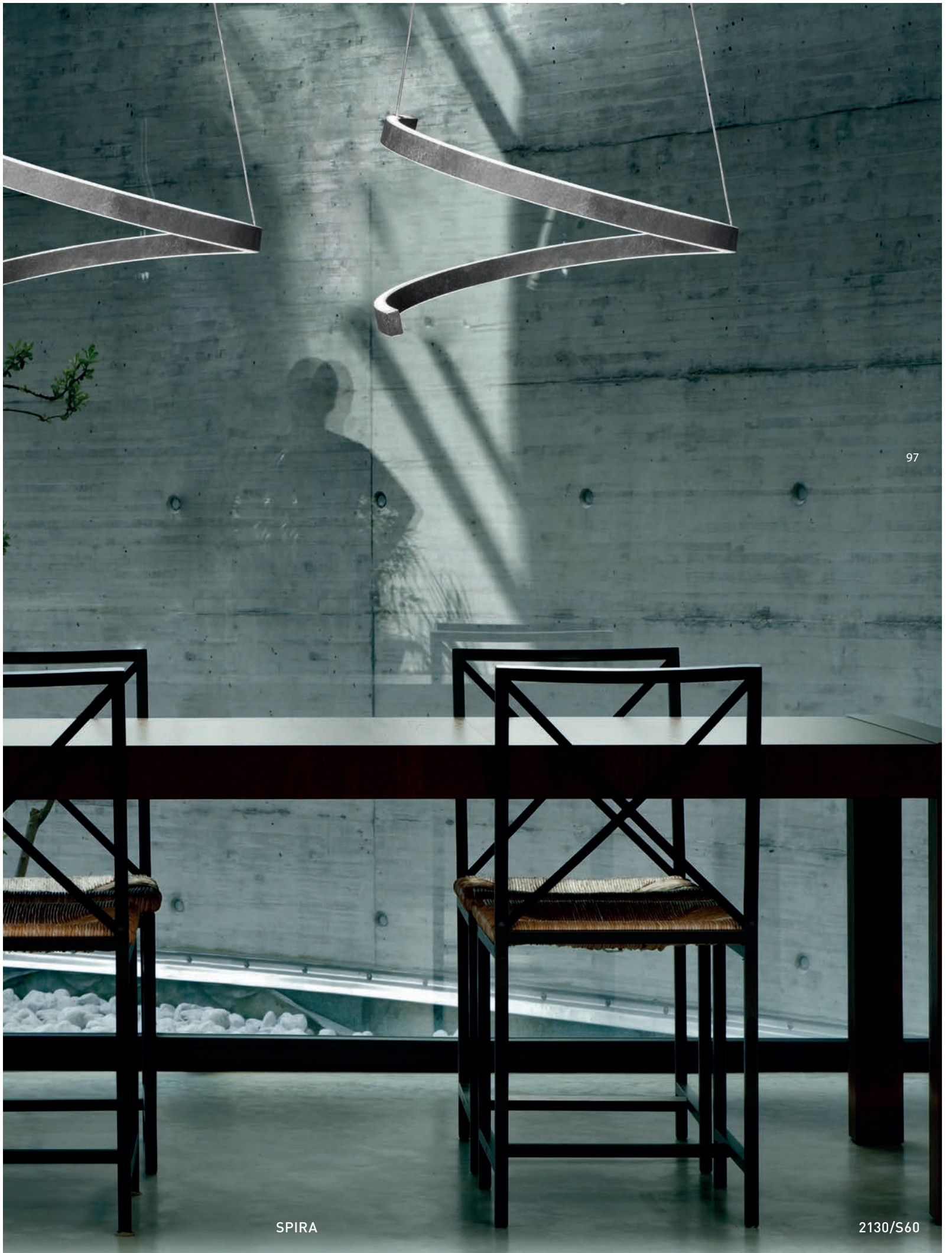

SPIRA

CRI > 80

DIMMERABILE / DIMMABLE

Vai a pagina / Go to page 457

DIFFUSORE / DIFFUSER

Silicone opalino
Opaline-finish Silicone

*** ROSONE / CANOPY**

Informazioni Tecniche vai a pag. 455
Technical info go to page 455

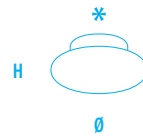

2133/R

Rosone con Alimentatore 75W
Base whit Power Supply 75W

H 30 mm
Ø 220 mm + Ø 190 mm

DIMMERABILE / DIMMABLE

2133/R - D4

Taglio di fase / Phase Cut

2133/R - D6

1-10V - DALI - PUSH

2133/R - D8

CASAMBI

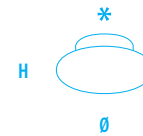

2129/R220-0-150

Rosone con Alimentatore 150W
Base whit Power Supply 150W

H 45 mm
Ø 280 mm + Ø 220 mm

DIMMERABILE / DIMMABLE

2129/R220-0-150 - D4

Taglio di fase / Phase Cut

2129/R220-0-150 - D6

1-10V - DALI - PUSH

2129/R220-0-150 - D8

CASAMBI

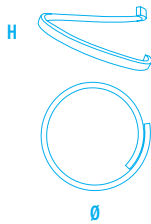

2130/TR60

W 57 - Vdc 24

Lm 3.450
M 2.700°K
C 3.000°K - W 4.000°K

Ø 600 mm
H 400 mm

ALIMENTATORE REMOTO
REMOTE POWER SUPPLY

ON/OFF
AL.100-24

DIMMERABILE / DIMMABLE

AL.75-24 - D4

Taglio di fase / Phase Cut

AL.100-24 - D6

1-10V - DALI - PUSH

AL.100-24 - D7

ZigBee

AL.100-24 - D8

CASAMBI

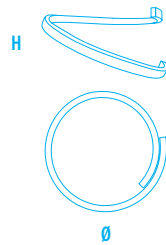

2130/TR75

W 71 - Vdc 24

Lm 4.250
M 2.700°K
C 3.000°K - W 4.000°K

Ø 750 mm
H 400 mm

ALIMENTATORE REMOTO
REMOTE POWER SUPPLY

ON/OFF
AL.100-24

DIMMERABILE / DIMMABLE

AL.75-24 - D4

Taglio di fase / Phase Cut

AL.100-24 - D6

1-10V - DALI - PUSH

AL.100-24 - D7

ZigBee

AL.100-24 - D8

CASAMBI



2130/TR90

W 88 - Vdc 24

Lm 5.250
M 2.700°K
C 3.000°K - W 4.000°K

Ø 900 mm
H 400 mm

ALIMENTATORE REMOTO
REMOTE POWER SUPPLY

ON/OFF
AL.100-24

DIMMERABILE / DIMMABLE

AL.100-24 - D4

Taglio di fase / Phase Cut

AL.100-24 - D6

1-10V - DALI - PUSH

AL.100-24 - D7

ZigBee

AL.100-24 - D8

CASAMBI



2130/TR110

W 115 - Vdc 24

Lm 6.900
M 2.700°K
C 3.000°K - W 4.000°K

Ø 1.100 mm
H 400 mm

ALIMENTATORE REMOTO
REMOTE POWER SUPPLY

ON/OFF
AL.150-24

DIMMERABILE / DIMMABLE

AL.200-24 - D4

Taglio di fase / Phase Cut

AL.150-24 - D6

1-10V - DALI - PUSH

AL.150-24 - D7

ZigBee

AL.150-24 - D8

CASAMBI

98

10
Bianco
White



13
Foglia Argento
Silver Leaf



14
Foglia Oro
Gold Leaf



15
Grigio
Grey



19
Nero
Black



21
Grigio tortora
Dove grey



22
Foglia rame
Copper leaf



23
Ruggine
Rust



24
Ferro
Iron



28
Oro
Gold



34
Rosè Verniciato
Painted Rosè



35
Bronzo Verniciato
Bronze Painted



BICOLORE / TWO-TONE

Vai a pagina / Go to page 454

19
Nero
Black



24
Ferro
Iron



10
Bianco
White



14
Foglia Oro
Gold Leaf



13
Foglia Argento
Silver Leaf



22
Foglia rame
Copper leaf







100

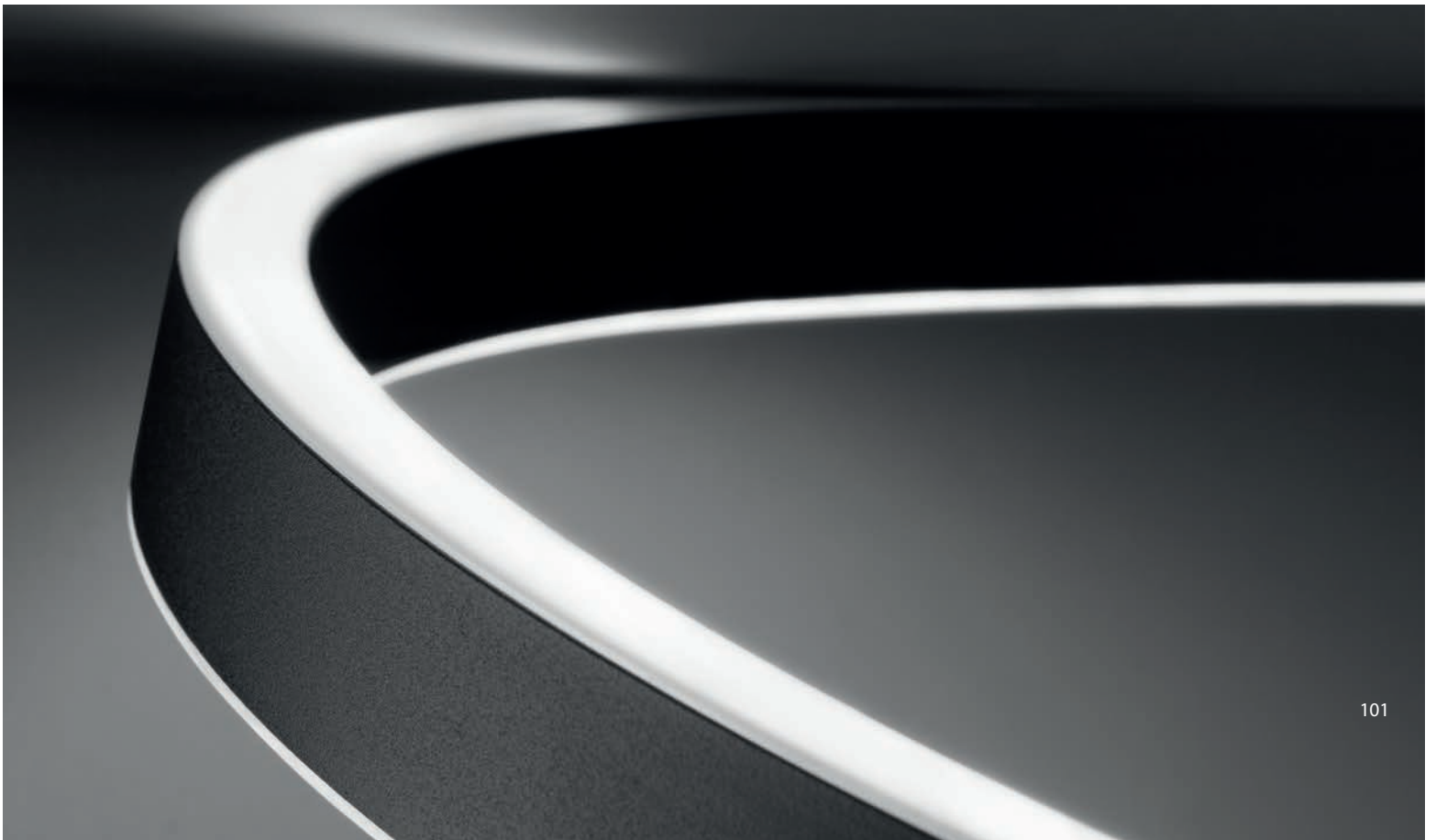

DIMMERABILE / DIMMABLE

Vai a pagina / Go to page 457

DIFFUSORE / DIFFUSER

Silicone opalino
Opaline-finish Silicone

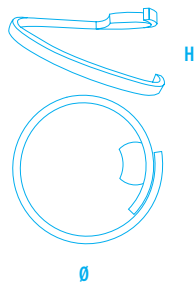

2130/PL60

W 57 - Vac 230

Lm 3.450
M 2.700°K
C 3.000°K - W 4.000°K

Ø 600 mm
H 400 mm

DIMMERABILE / DIMMABLE

2130/PL60 - D4

Taglio di fase / Phase Cut

2130/PL60 - D6

1-10V - DALI - PUSH

2130/PL60 - D8
CASAMBI

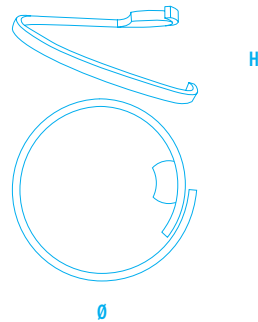

2130/PL75

W 71 - Vac 230

Lm 4.250
M 2.700°K
C 3.000°K - W 4.000°K

Ø 750 mm
H 400 mm

DIMMERABILE / DIMMABLE

2130/PL75 - D4

Taglio di fase / Phase Cut

2130/PL75 - D6

1-10V - DALI - PUSH

2130/PL75 - D8
CASAMBI

10

Bianco
White



13

Foglia Argento
Silver Leaf



14

Foglia Oro
Gold Leaf



15

Grigio
Grey



19

Nero
Black



21

Grigio tortora
Dove grey



22

Foglia rame
Copper leaf



23

Ruggine
Rust



24

Ferro
Iron



28

Oro
Gold



34

Rosè Verniciato
Painted Rosè



35

Bronzo Verniciato
Bronze Painted



BICOLORE / TWO-TONE

Vai a pagina / Go to page 454

19

Nero
Black

/

14

Foglia Oro
Gold Leaf



24

Ferro
Iron

/

13

Foglia Argento
Silver Leaf



10

Bianco
White

/

22

Foglia rame
Copper leaf



Round

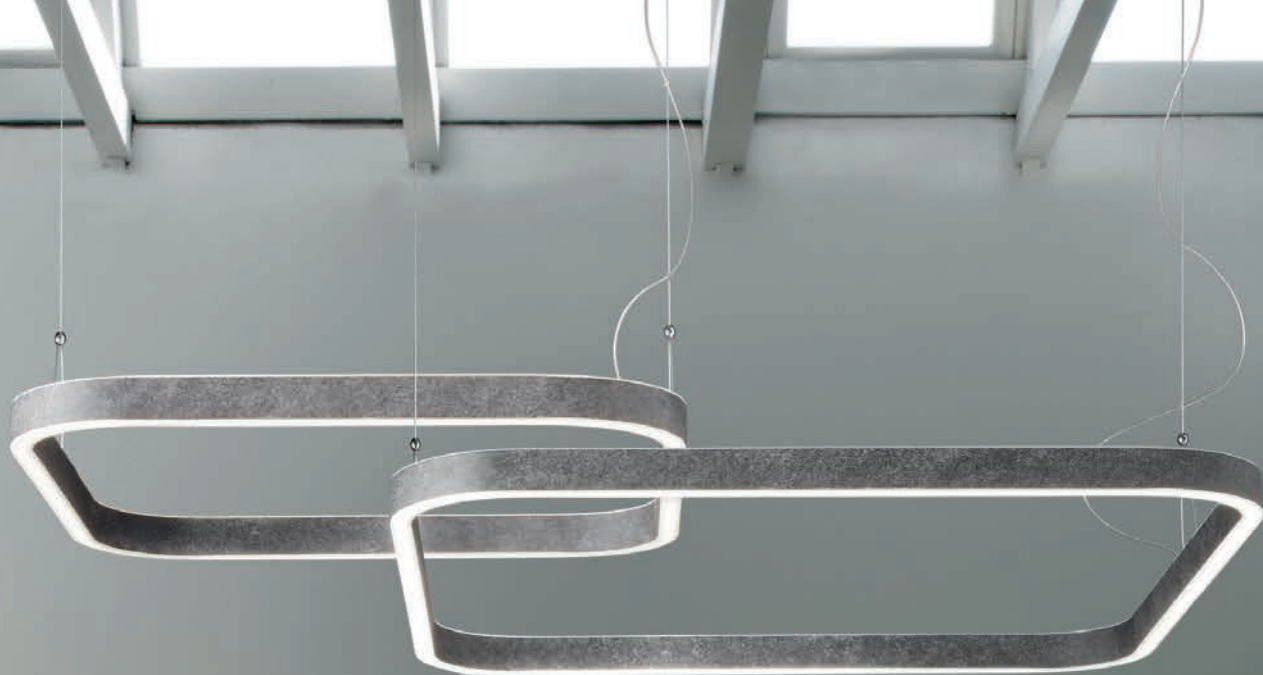

102

2131/S60 + 2131/S80

BRAGA LED



ROUND

CRI > 80

DIMMERABILE / DIMMABLE

Vai a pagina / Go to page 457

DIFFUSORE / DIFFUSER

Silicone opalino
Opaline-finish Silicone

*** ROSONE / CANOPY**

Informazioni Tecniche vai a pag. 455
Technical info go to page 455

104

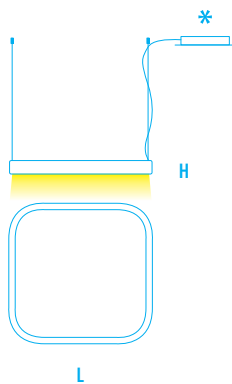

2131/S60-1

W 45 - Vac 230

Lm 2.700
M 2.700°K
C 3.000°K - W 4.000°K

L 600 mm
H 40 mm
L CAVI / CABLES 2.000 mm

DIMMERABILE / DIMMABLE

2131/S60-1 - D4
Taglio di fase / Phase Cut

2131/S60-1 - D6
1-10V - DALI - PUSH

2131/S60-1 - D7
ZigBee

2131/S60-1 - D8
CASAMBI

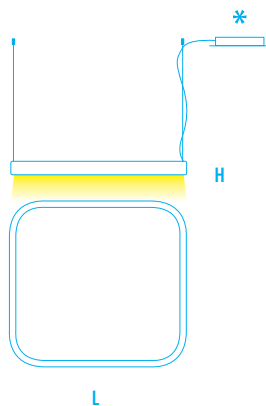

2131/S80-1

W 63 - Vac 230

Lm 3.800
M 2.700°K
C 3.000°K - W 4.000°K

L 800 mm
H 40 mm
L CAVI / CABLES 2.000 mm

DIMMERABILE / DIMMABLE

2131/S80-1 - D4
Taglio di fase / Phase Cut

2131/S80-1 - D6
1-10V - DALI - PUSH

2131/S80-1 - D7
ZigBee

2131/S80-1 - D8
CASAMBI

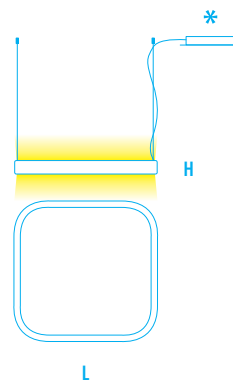

2131/S60-2

W 90 - Vac 230

Lm 5.400
M 2.700°K
C 3.000°K - W 4.000°K

L 600 mm
H 40 mm
L CAVI / CABLES 2.000 mm

DIMMERABILE / DIMMABLE

2131/S60-2 - D4
Taglio di fase / Phase Cut

2131/S60-2 - D6
1-10V - DALI - PUSH

2131/S60-2 - D7
ZigBee

2131/S60-2 - D8
CASAMBI

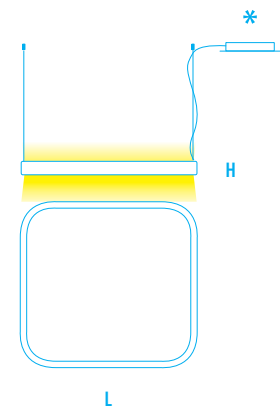

2131/S80-2

W 126 - Vac 230

Lm 7.600
M 2.700°K
C 3.000°K - W 4.000°K

L 800 mm
H 40 mm
L CAVI / CABLES 2.000 mm

DIMMERABILE / DIMMABLE

2131/S80-2 - D4
Taglio di fase / Phase Cut

2131/S80-2 - D6
1-10V - DALI - PUSH

2131/S80-2 - D7
ZigBee

2131/S80-2 - D8
CASAMBI

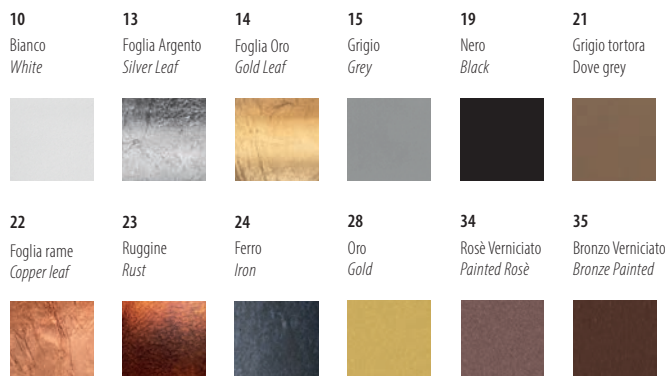

BICOLORE / TWO-TONE

Vai a pagina / Go to page 454



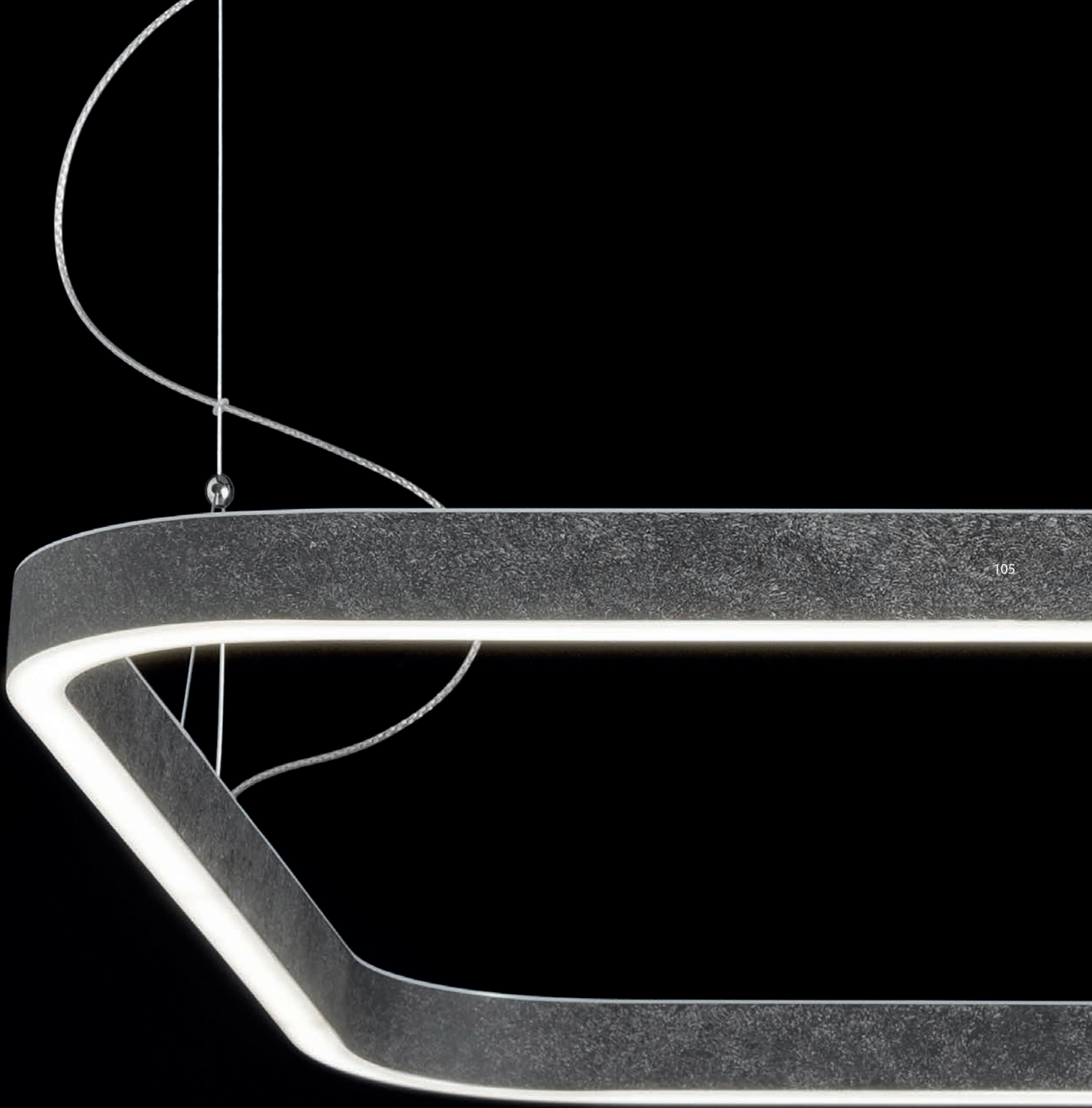



ROUND

CRI > 80

DIMMERABILE / DIMMABLE

Vai a pagina / Go to page 457

DIFFUSORE / DIFFUSER

Silicone opalino
Opaline-finish Silicone

*** ROSONE / CANOPY**

Informazioni Tecniche vai a pag. 455
Technical info go to page 455

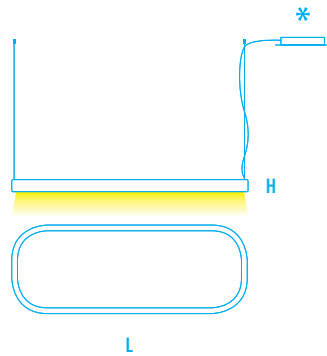

2132/S125-1

W 63 - Vac 230

Lm 3.800
M 2.700°K
C 3.000°K - W 4.000°K

L 1.250 x 370 mm
H 40 mm
L CAVI / CABLES 2.000 mm

DIMMERABILE / DIMMABLE

- 2132/S125-1 - D4
Taglio di fase / Phase Cut
- 2132/S125-1 - D6
1-10V - DALI - PUSH
- 2131/S125-1 - D7
ZigBee
- 2131/S125-1 - D8
CASAMBI

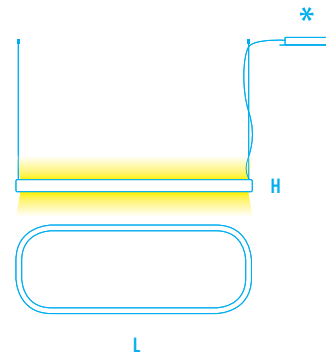

2132/S125-2













W 126 - Vac 230

Lm 7.600
M 2.700°K
C 3.000°K - W 4.000°K

L 1.250 x 370 mm
H 40 mm
L CAVI / CABLES 2.000 mm

DIMMERABILE / DIMMABLE

- 2132/S125-2 - D4
Taglio di fase / Phase Cut
- 2132/S125-2 - D6
1-10V - DALI - PUSH
- 2131/S125-2 - D7
ZigBee
- 2131/S125-2 - D8
CASAMBI

| | | | | | |
|--|---|---|--|--|---|
| <p>10 Bianco White</p>  | <p>13 Foglia Argento Silver Leaf</p>  | <p>14 Foglia Oro Gold Leaf</p>  | <p>15 Grigio Grey</p>  | <p>19 Nero Black</p>  | <p>21 Grigio tortora Dove grey</p>  |
| <p>22 Foglia rame Copper leaf</p>  | <p>23 Ruggine Rust</p>  | <p>24 Ferro Iron</p>  | <p>28 Oro Gold</p>  | <p>34 Rosè Verniciato Painted Rosè</p>  | <p>35 Bronzo Verniciato Bronze Painted</p>  |

BICOLORE / TWO-TONE

Vai a pagina / Go to page 454

| | | |
|---|---|--|
| <p>19 Nero Black /</p>  | <p>24 Ferro Iron /</p>  | <p>10 Bianco White /</p>  |
| <p>14 Foglia Oro Gold Leaf</p>  | <p>13 Foglia Argento Silver Leaf</p>  | <p>22 Foglia rame Copper leaf</p>  |



108



2131/TR80

BRAGA LED

ROUND

CRI > 80

DIMMERABILE / DIMMABLE

Vai a pagina / Go to page 457

DIFFUSORE / DIFFUSER

Silicone opalino
Opaline-finish Silicone

*** ROSONE / CANOPY**

Informazioni Tecniche vai a pag. 455
Technical info go to page 455

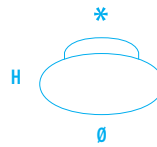

2133/R

ROSONE CON ALIMENTATORE 75W
BASE WITH POWER SUPPLY 75W

H 30 mm
Ø 220 mm + Ø 190 mm

DIMMERABILE / DIMMABLE

2133/R - D4

Taglio di fase / Phase Cut

2133/R - D6

1-10V - DALI - PUSH

2133/R - D8

CASAMBI

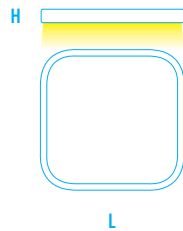

2131/TR60

W 45 - Vdc 24

Lm 2.700
M 2.700°K
C 3.000°K - W 4.000°K

L 600 mm
H 40 mm

ALIMENTATORE REMOTO
REMOTE POWER SUPPLY

ON/OFF

AL.60-24

DIMMERABILE / DIMMABLE

AL.50-24 - D4

Taglio di fase / Phase Cut

AL.60-24 - D6

1-10V - DALI - PUSH

AL.60-24 - D7

ZigBee

AL.60-24 - D8

CASAMBI

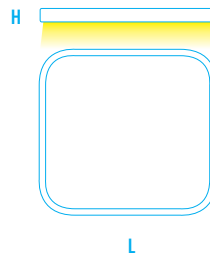

2131/TR80

W 63 - Vdc 24

Lm 3.800
M 2.700°K
C 3.000°K - W 4.000°K

L 800 mm
H 40 mm

ALIMENTATORE REMOTO
REMOTE POWER SUPPLY

ON/OFF

AL.100-24

DIMMERABILE / DIMMABLE

AL.75-24 - D4

Taglio di fase / Phase Cut

AL.100-24 - D6

1-10V - DALI - PUSH

AL.100-24 - D7

ZigBee

AL.100-24 - D8

CASAMBI

10

Bianco
White



13

Foglia Argento
Silver Leaf



14

Foglia Oro
Gold Leaf



15

Grigio
Grey



19

Nero
Black



21

Grigio tortora
Dove grey



22

Foglia rame
Copper leaf



23

Ruggine
Rust



24

Ferro
Iron



28

Oro
Gold



34

Rosè Verniciato
Painted Rosè



35

Bronzo Verniciato
Bronze Painted



BICOLORE / TWO-TONE

Vai a pagina / Go to page 454

19

Nero
Black

/

14

Foglia Oro
Gold Leaf



24

Ferro
Iron

/

13

Foglia Argento
Silver Leaf



10

Bianco
White

/

22

Foglia rame
Copper leaf







CRI > 80

DIMMERABILE / DIMMABLE

Vai a pagina / Go to page 457

DIFFUSORE / DIFFUSER

Silicone opalino
Opaline-finish Silicone

*** ROSONE / CANOPY**

Informazioni Tecniche vai a pag. 455
Technical info go to page 455

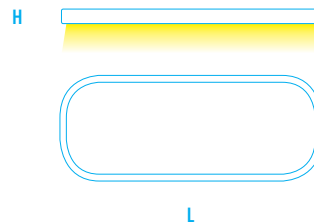

2132/TR125

W 63 - Vdc 24

Lm 3.800

M 2.700°K

C 3.000°K - W 4.000°K

L 1.250 x 370 mm

H 40 mm

ALIMENTATORE REMOTO
REMOTE POWER SUPPLY

ON/OF

AL.100-24

DIMMERABILE / DIMMABLE

AL.75-24 - D4

Taglio di fase / Phase Cut

AL.100-24 - D6

1-10V - DALI - PUSH

AL.100-24 - D7

ZigBee

AL.100-24 - D8

CASAMBI

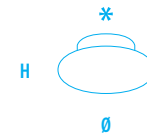

2133/R

Rosone con Alimentatore 75W
Base whit Power Supply 75W

H 30 mm

Ø 220 mm + Ø 190 mm

DIMMERABILE / DIMMABLE

2133/R - D4

Taglio di fase / Phase Cut

2133/R - D6

1-10V - DALI - PUSH

2133/R - D8

CASAMBI

10

Bianco
White



13

Foglia Argento
Silver Leaf



14

Foglia Oro
Gold Leaf



15

Grigio
Grey



19

Nero
Black



21

Grigio tortora
Dove grey



22

Foglia rame
Copper leaf



23

Ruggine
Rust



24

Ferro
Iron



28

Oro
Gold



34

Rosè Verniciato
Painted Rosè



35

Bronzo Verniciato
Bronze Painted



BICOLORE / TWO-TONE

Vai a pagina / Go to page 454

19

Nero
Black

/

/

14

Foglia Oro
Gold Leaf

/

/

/

/

/

/

/

24

Ferro
Iron

/

/

13

Foglia Argento
Silver Leaf

/

/

/

/

/

/

/

10

Bianco
White

/

/

22

Foglia rame
Copper leaf

/

/

/

/

/

/

/



ROUND

CRI > 80

DIMMERABILE / DIMMABLE

Vai a pagina / Go to page 457

DIFFUSORE / DIFFUSER

Silicone opalino

Opaline-finish Silicone

112

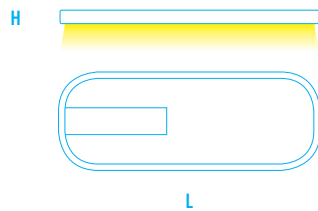

2132/PL125

W 63 - Vac 230

Lm 3.800

M 2.700°K

C 3.000°K - W 4.000°K

L 1.250 x 370 mm

H 40 mm

DIMMERABILE / DIMMABLE

2132/PL125 - D4

Taglio di fase / Phase Cut

2132/PL125 - D6

1-10V - DALI - PUSH

2132/PL125 - D7

ZigBee

2132/PL125 - D8

CASAMBI

| | | | | | |
|---|--|--------------------------------------|-----------------------------|--|--|
| 10 Bianco White | 13 Foglia Argento Silver Leaf | 14 Foglia Oro Gold Leaf | 15 Grigio Grey | 19 Nero Black | 21 Grigio tortora Dove grey |
| | | | | | |
| 22 Foglia rame Copper leaf | 23 Ruggine Rust | 24 Ferro Iron | 28 Oro Gold | 34 Rosè Verniciato Painted Rosè | 35 Bronzo Verniciato Bronze Painted |
| | | | | | |

BICOLORE / TWO-TONE

Vai a pagina / Go to page 454

| | | |
|--------------------------------------|--|---|
| 19 Nero Black / | 24 Ferro Iron / | 10 Bianco White / |
| 14 Foglia Oro Gold Leaf | 13 Foglia Argento Silver Leaf | 22 Foglia rame Copper leaf |
| | | |
| | | |



ROUND

2132/PL125

Clock

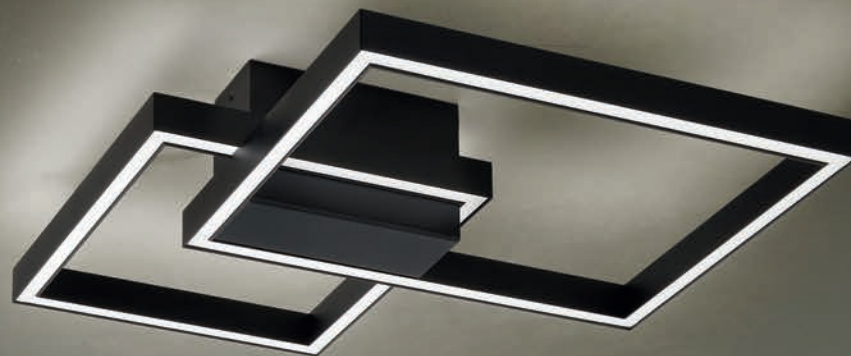

114



2160/PL80-2

BRAGA LED



CLOCK

2160/PL60-1



CLOCK

CRI > 80

DIMMERABILE / DIMMABLE

Vai a pagina / Go to page 457

DIFFUSORE / DIFFUSER

Metacrilato opalino

Opaline-finish methacrylate

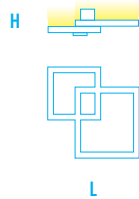

2160/PL50-1

W 58 - Vac 230

Lm 3.350
M 2.700°K
C 3.000°K - W 4.000°K

L 500x350 mm
H 160 mm

DIMMERABILE / DIMMABLE

2160/PL50-1 - D4
Taglio di fase / Phase Cut

2160/PL50-1 - D6
1-10V - DALI - PUSH

2160/PL50-1 - D7
ZigBee

2160/PL50-1 - D8
CASAMBI

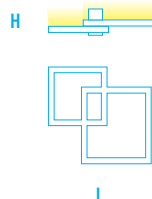

2160/PL60-1

W 67 - Vac 230

Lm 3.850
M 2.700°K
C 3.000°K - W 4.000°K

L 600x400 mm
H 160 mm

DIMMERABILE / DIMMABLE

2160/PL60-1 - D4
Taglio di fase / Phase Cut

2160/PL60-1 - D6
1-10V - DALI - PUSH

2160/PL60-1 - D7
ZigBee

2160/PL60-1 - D8
CASAMBI

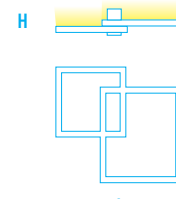

2160/PL80-1

W 84 - Vac 230

Lm 4.850
M 2.700°K
C 3.000°K - W 4.000°K

L 800x500 mm
H 160 mm

DIMMERABILE / DIMMABLE

2160/PL80-1 - D4
Taglio di fase / Phase Cut

2160/PL80-1 - D6
1-10V - DALI - PUSH

2160/PL80-1 - D7
ZigBee

2160/PL80-1 - D8
CASAMBI



2160/PL50-2

W 94 - Vac 230

Lm 5.950
M 2.700°K
C 3.000°K - W 4.000°K

L 500x350 mm
H 160 mm

DIMMERABILE / DIMMABLE

2160/PL50-2 - D4
Taglio di fase / Phase Cut

2160/PL50-2 - D6
1-10V - DALI - PUSH

2160/PL50-2 - D7
ZigBee

2160/PL50-2 - D8
CASAMBI

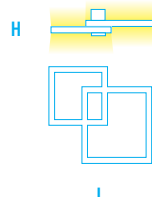

2160/PL60-2

W 108 - Vac 230

Lm 6.850
M 2.700°K
C 3.000°K - W 4.000°K

L 600x400 mm
H 160 mm

DIMMERABILE / DIMMABLE

2160/PL60-2 - D4
Taglio di fase / Phase Cut

2160/PL60-2 - D6
1-10V - DALI - PUSH

2160/PL60-2 - D7
ZigBee

2160/PL60-2 - D8
CASAMBI

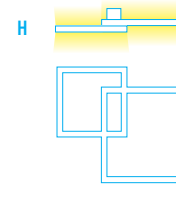

2160/PL80-2

W 136 - Vac 230

Lm 8.550
M 2.700°K
C 3.000°K - W 4.000°K

L 800x500 mm
H 160 mm

DIMMERABILE / DIMMABLE

2160/PL80-2 - D4
Taglio di fase / Phase Cut

2160/PL80-2 - D6
1-10V - DALI - PUSH

2160/PL80-2 - D7
ZigBee

2160/PL80-2 - D8
CASAMBI

10
Bianco
White

15
Grigio
Grey

19
Nero
Black

21
Grigio tortora
Dove grey

28
Oro
Gold

34
Rosè Verniciato
Painted Rosè

35
Bronzo Verniciato
Painted Bronze



Flat

118



2137/S55 + 2137/S75 + 2137/S90 + 2137/S120

BRAGA LED

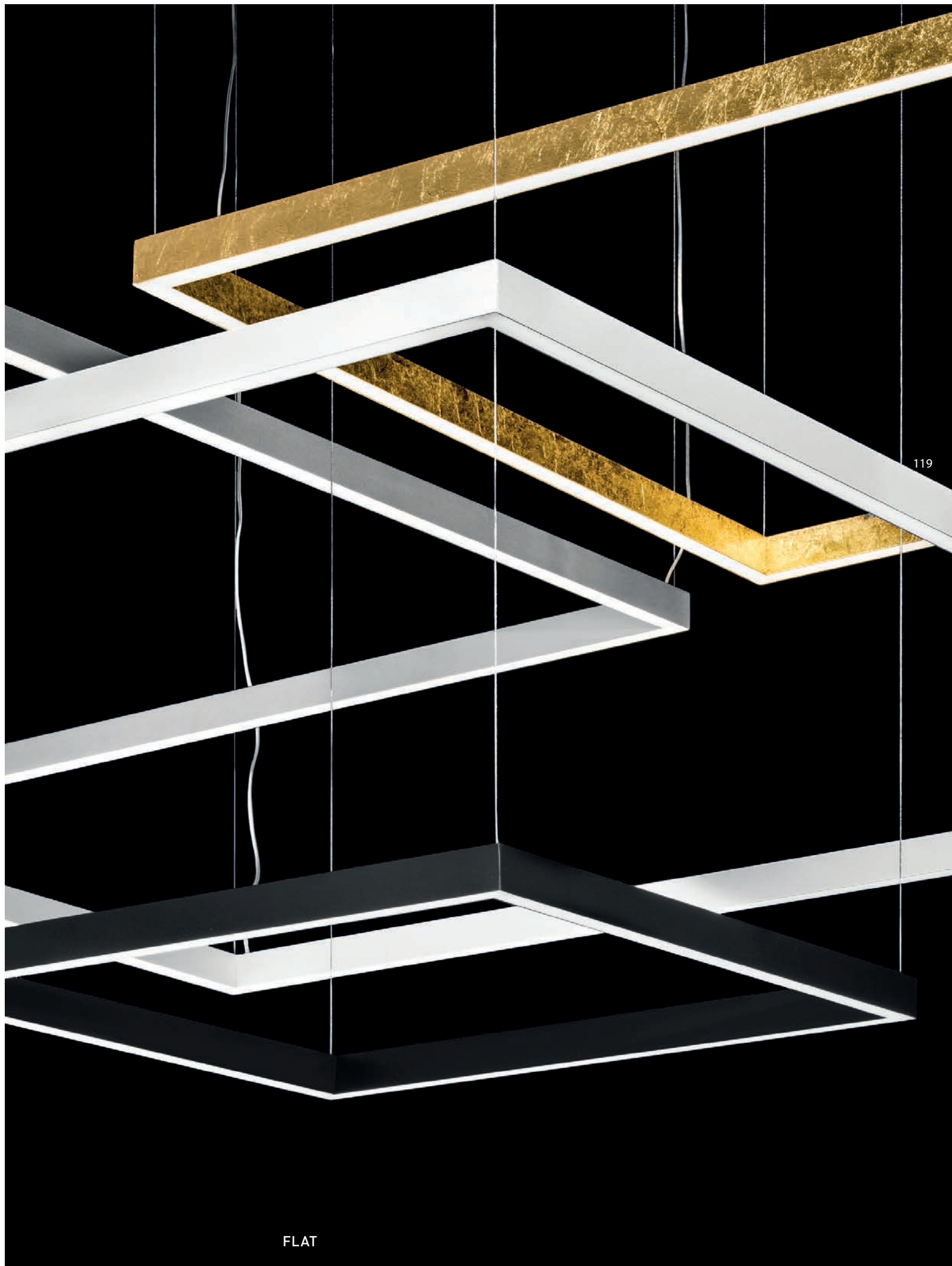

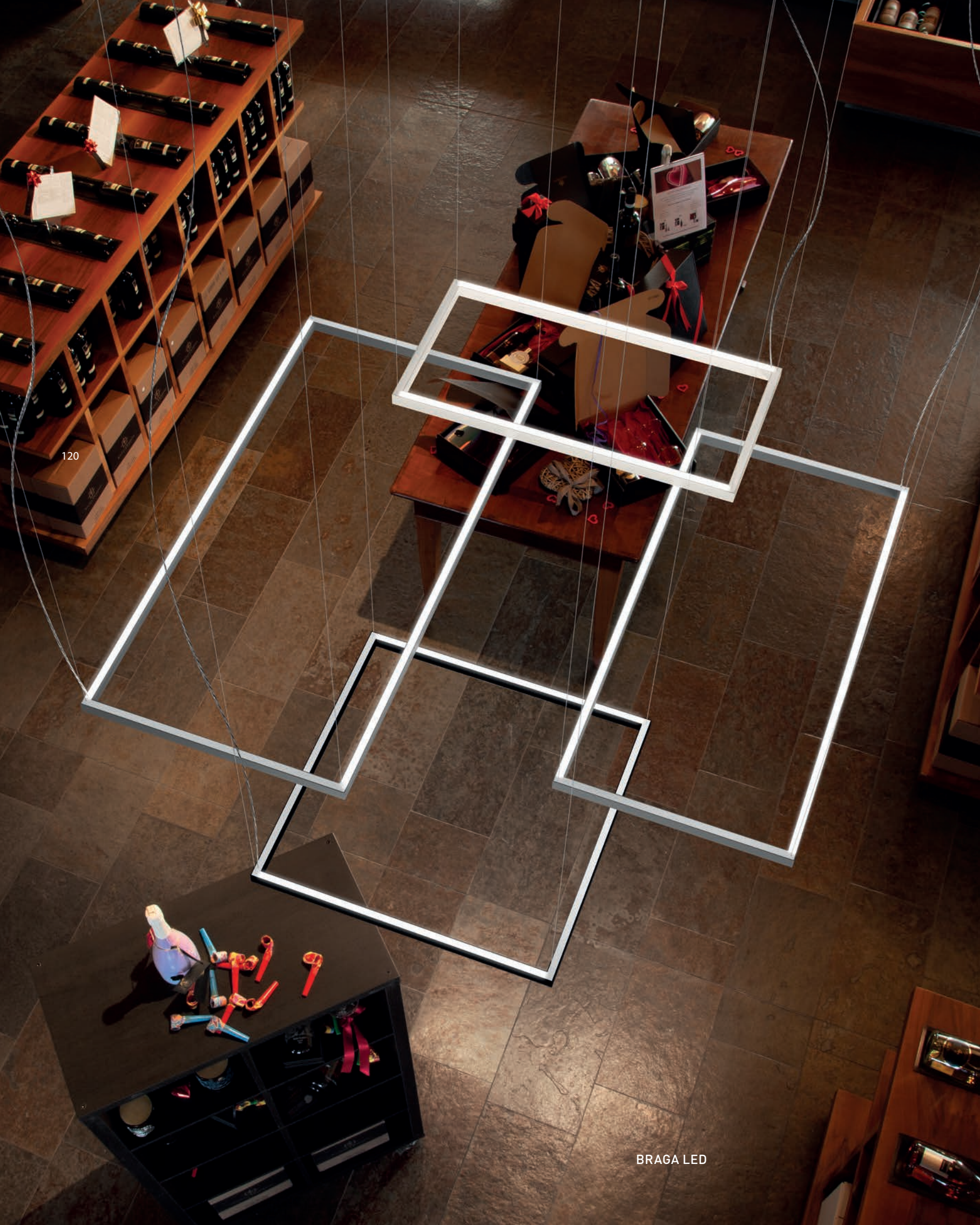

120

BRAGA LED

FLAT

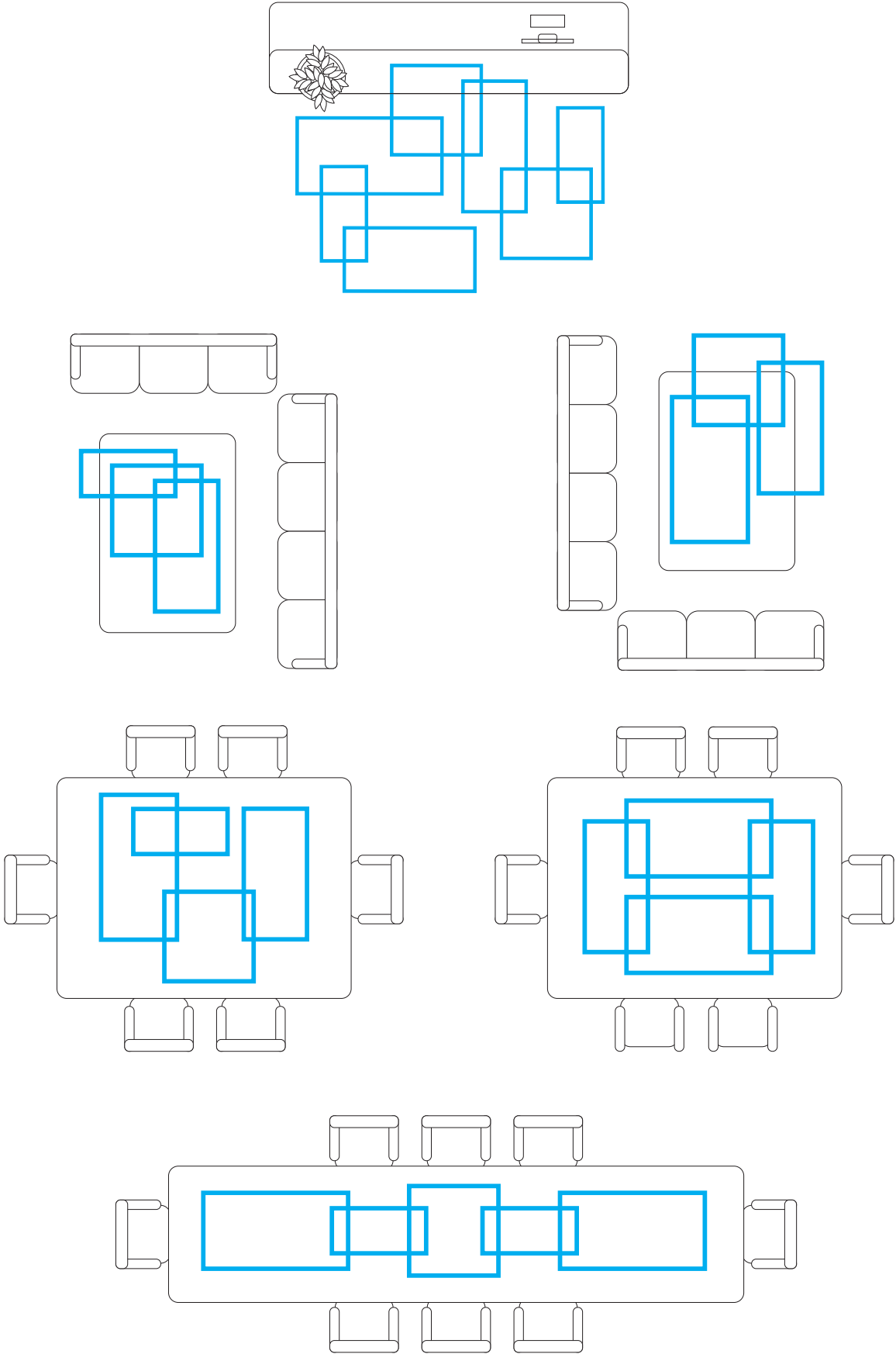

FLAT

CRI > 80

DIMMERABILE / DIMMABLE

Vai a pagina / Go to page 457

DIFFUSORE / DIFFUSER

Metacrilato opalino

Opaline-finish methacrylate

*** ROSONE / CANOPY**

Informazioni Tecniche vai a pag. 453

Technical info go to page 453

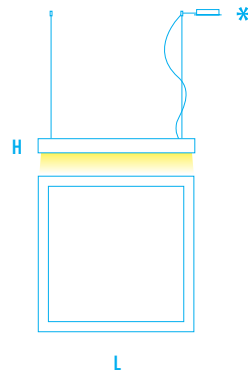

2137/S55-1

W 36 - **Vac** 230

Lm 2.300

M 2.700°K

C 3.000°K - **W** 4.000°K

L 550 x 550 mm

H 35 mm

L CAVI / CABLES 2.000 mm

DIMMERABILE / DIMMABLE

2137/S55-1 - D4

Taglio di fase / Phase Cut

2137/S55-1 - D6

1-10V - DALI - PUSH

2137/S55-1 - D7

ZigBee

2137/S55-1 - D8

CASAMBI

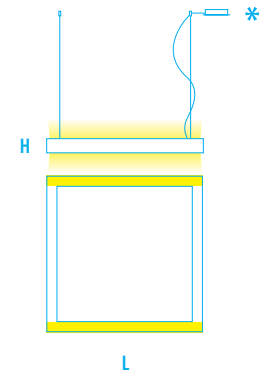

2137/S55-2

W 53 - **Vac** 230

Lm 2.300 (down) 1.000 (up)

M 2.700°K

C 3.000°K - **W** 4.000°K

L 550 x 550 mm

H 35 mm

L CAVI / CABLES 2.000 mm

DIMMERABILE / DIMMABLE

2137/S55-2 - D4

Taglio di fase / Phase Cut

2137/S55-2 - D6

1-10V - DALI - PUSH

2137/S55-2 - D7

ZigBee

2137/S55-2 - D8

CASAMBI

122

10

Bianco
White



13

Foglia Argento
Silver Leaf



14

Foglia Oro
Gold Leaf



15

Grigio
Grey



19

Nero
Black



21

Grigio tortora
Dove grey



22

Foglia rame
Copper leaf



23

Ruggine
Rust



24

Ferro
Iron



28

Oro
Gold



34

Rosè Verniciato
Painted Rosè



35

Bronzo Verniciato
Bronze Painted



BICOLORE / TWO-TONE

Vai a pagina / Go to page 454

19

Nero
Black



24

Ferro
Iron



10

Bianco
White



14

Foglia Oro
Gold Leaf



13

Foglia Argento
Silver Leaf



22

Foglia rame
Copper leaf

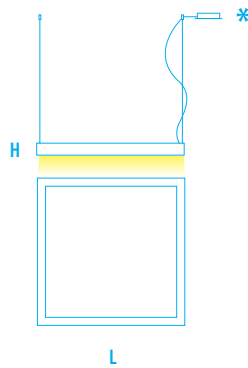

2137/S75-1

W 51 - **Vac** 230

Lm 3.200

M 2.700°K

C 3.000°K - **W** 4.000°K

L 750 x 750 mm

H 35 mm

L CAVI / CABLES 2.000 mm

DIMMERABILE / DIMMABLE

2137/S75-1 - D4

Taglio di fase / Phase Cut

2137/S75-1 - D6

1-10V - DALI - PUSH

2137/S75-1 - D7

ZigBee

2137/S75-1 - D8

CASAMBI

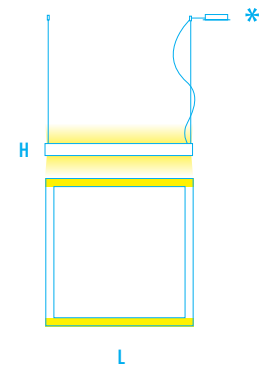

2137/S75-2

W 76 - **Vac** 230

Lm 3.200 (down) 1.600 (up)

M 2.700°K

C 3.000°K - **W** 4.000°K

L 750 x 750 mm

H 35 mm

L CAVI / CABLES 2.000 mm

DIMMERABILE / DIMMABLE

2137/S75-2 - D4

Taglio di fase / Phase Cut

2137/S75-2 - D6

1-10V - DALI - PUSH

2137/S75-2 - D7

ZigBee

2137/S75-2 - D8

CASAMBI



FLAT

CRI > 80

DIMMERABILE / DIMMABLE

Vai a pagina / Go to page 457

DIFFUSORE / DIFFUSER

Metacrilato opalino
Opaline-finish methacrylate

* ROSONE / CANOPY

Informazioni Tecniche vai a pag. 455
Technical info go to page 455

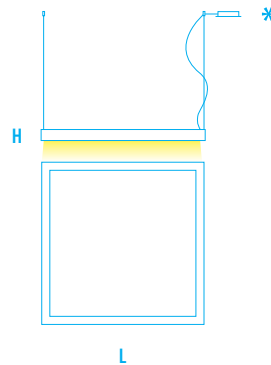

2137/S90-1

W 62 - Vac 230

Lm 3.900

M 2.700°K

C 3.000°K - W 4.000°K

L 900 x 900 mm

H 35 mm

L CAVI / CABLES 2.000 mm

DIMMERABILE / DIMMABLE

2137/S90-1 - D4

Taglio di fase / Phase Cut

2137/S90-1 - D6

1-10V - DALI - PUSH

2137/S90-1 - D7

ZigBee

2137/S90-1 - D8

CASAMBI

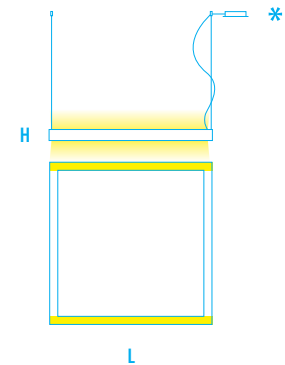

2137/S90-2

W 89 - Vac 230

Lm 3.900 (down) 1.700 (up)

M 2.700°K

C 3.000°K - W 4.000°K

L 900 x 900 mm

H 35 mm

L CAVI / CABLES 2.000 mm

DIMMERABILE / DIMMABLE

2137/S90-2 - D4

Taglio di fase / Phase Cut

2137/S90-2 - D6

1-10V - DALI - PUSH

2137/S90-2 - D7

ZigBee

2137/S90-2 - D8

CASAMBI

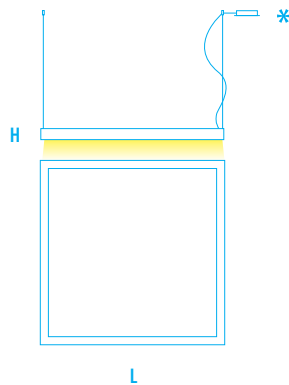

2137/S120-1

W 82 - Vac 230

Lm 5.200

M 2.700°K

C 3.000°K - W 4.000°K

L 1200 x 1200 mm

H 35 mm

L CAVI / CABLES 2.000 mm

DIMMERABILE / DIMMABLE

2137/S120-1 - D4

Taglio di fase / Phase Cut

2137/S120-1 - D6

1-10V - DALI - PUSH

2137/S120-1 - D7

ZigBee

2137/S120-1 - D8

CASAMBI

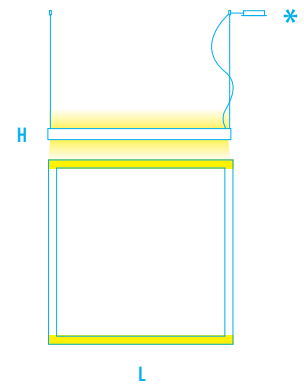

2137/S120-2

W 123 - Vac 230

Lm 5.200 (down) 2.600 (up)

M 2.700°K

C 3.000°K - W 4.000°K

L 1200 x 1200 mm

H 35 mm

L CAVI / CABLES 2.000 mm

DIMMERABILE / DIMMABLE

2137/S120-2 - D4

Taglio di fase / Phase Cut

2137/S120-2 - D6

1-10V - DALI - PUSH

2137/S120-2 - D7

ZigBee

2137/S120-2 - D8

CASAMBI

124

10

Bianco
White



13

Foglia Argento
Silver Leaf



14

Foglia Oro
Gold Leaf



15

Grigio
Grey



19

Nero
Black



21

Grigio tortora
Dove grey



22

Foglia rame
Copper leaf



23

Ruggine
Rust



24

Ferro
Iron



28

Oro
Gold



34

Rosè Verniciato
Painted Rosè



35

Bronzo Verniciato
Bronze Painted



BICOLORE / TWO-TONE

Vai a pagina / Go to page 454

19

Nero
Black
/



24

Ferro
Iron
/



10

Bianco
White
/



14

Foglia Oro
Gold Leaf



13

Foglia Argento
Silver Leaf



22

Foglia rame
Copper leaf



FLAT

CRI > 80

DIMMERABILE / DIMMABLE

Vai a pagina / Go to page 457

DIFFUSORE / DIFFUSER

Metacrilato opalino
Opaline-finish methacrylate

* ROSONE / CANOPY

Informazioni Tecniche vai a pag. 455
Technical info go to page 455



BICOLORE / TWO-TONE

Vai a pagina / Go to page 454

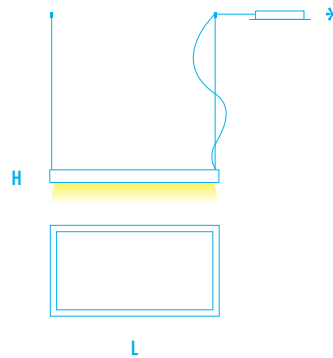

2138/S79-1

W 38 - Vac 230

Lm 2.400

M 2.700°K

C 3.000°K - W 4.000°K

L 790 x 390 mm

H 35 mm

L CAVI / CABLES 2.000 mm

DIMMERABILE / DIMMABLE

2138/S79-1 - D4

Taglio di fase / Phase Cut

2138/S79-1 - D6

1-10V - DALI - PUSH

2138/S79-1 - D7

ZigBee

2138/S79-1 - D8

CASAMBI

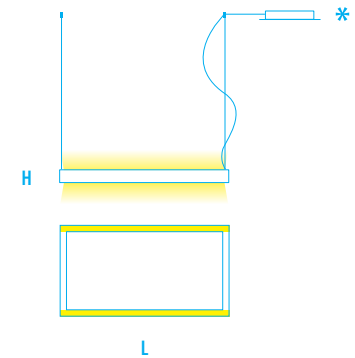

2138/S79-2

W 65 - Vac 230

Lm 2.400 (down) 1.700 (up)

M 2.700°K

C 3.000°K - W 4.000°K

L 790 x 390 mm

H 35 mm

L CAVI / CABLES 2.000 mm

DIMMERABILE / DIMMABLE

2138/S79-2 - D4

Taglio di fase / Phase Cut

2138/S79-2 - D6

1-10V - DALI - PUSH

2138/S79-2 - D7

ZigBee

2138/S79-2 - D8

CASAMBI

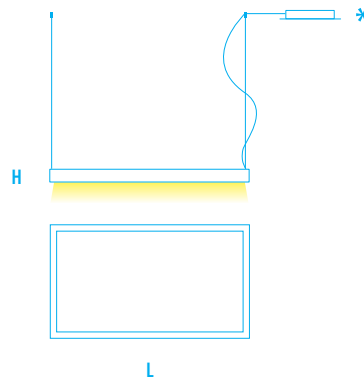

2138/S109-1

W 55 - Vac 230

Lm 3.450

M 2.700°K

C 3.000°K - W 4.000°K

L 1.090 x 540 mm

H 35 mm

L CAVI / CABLES 2.000 mm

DIMMERABILE / DIMMABLE

2138/S109-1 - D4

Taglio di fase / Phase Cut

2138/S109-1 - D6

1-10V - DALI - PUSH

2138/S109-1 - D7

ZigBee

2138/S109-1 - D8

CASAMBI

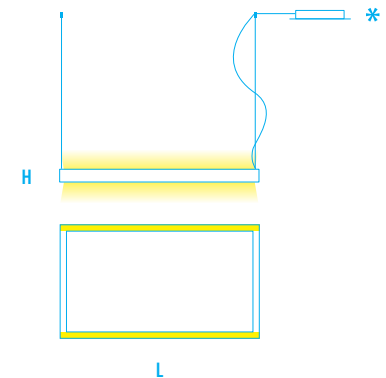

2138/S109-2

W 91 - Vac 230

Lm 3.450 (down) 2.250 (up)

M 2.700°K

C 3.000°K - W 4.000°K

L 1.090 x 540 mm

H 35 mm

L CAVI / CABLES 2.000 mm

DIMMERABILE / DIMMABLE

2138/S109-2 - D4

Taglio di fase / Phase Cut

2138/S109-2 - D6

1-10V - DALI - PUSH

2138/S109-2 - D7

ZigBee

2138/S109-2 - D8

CASAMBI



FLAT

CRI > 80

DIMMERABILE / DIMMABLE

Vai a pagina / Go to page 457

DIFFUSORE / DIFFUSER

Metacrilato opalino
Opaline-finish methacrylate

* ROSONE / CANOPY

Informazioni Tecniche vai a pag. 455
Technical info go to page 455

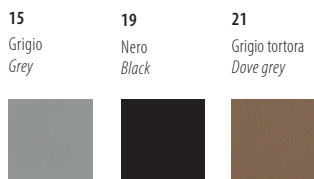

BICOLORE / TWO-TONE

Vai a pagina / Go to page 454

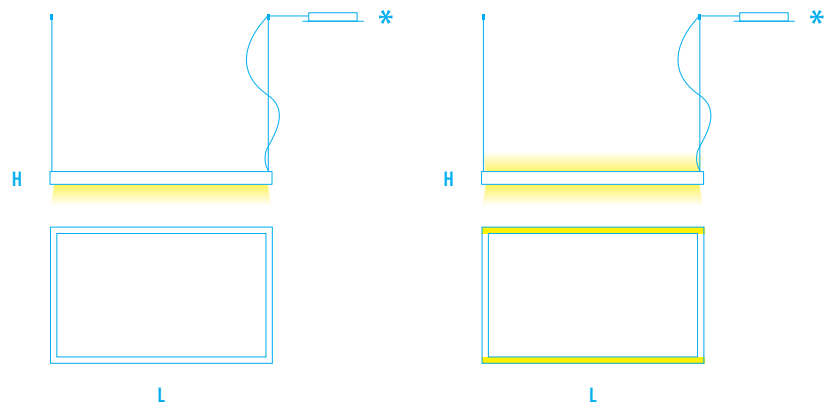

2138/S129-1

W 65 - Vac 230

Lm 4.150
M 2.700°K
C 3.000°K - W 4.000°K

L 1.290 x 640 mm
H 35 mm
L CAVI / CABLES 2.000 mm

DIMMERABILE / DIMMABLE

2138/S129-1 - D4
Taglio di fase / Phase Cut

2138/S129-1 - D6
1-10V - DALI - PUSH

2138/S129-1 - D7
ZigBee

2138/S129-1 - D8
CASAMBI

2138/S129-2

W 108 - Vac 230

Lm 4.150 (down) 2.700 (up)
M 2.700°K
C 3.000°K - W 4.000°K

L 1.290 x 640 mm
H 35 mm
L CAVI / CABLES 2.000 mm

DIMMERABILE / DIMMABLE

2138/S129-2 - D4
Taglio di fase / Phase Cut

2138/S129-2 - D6
1-10V - DALI - PUSH

2138/S129-2 - D7
ZigBee

2138/S129-2 - D8
CASAMBI

FLAT

CRI > 80

DIMMERABILE / DIMMABLE

Vai a pagina / Go to page 457

DIFFUSORE / DIFFUSER

Metacrilato opalino
Opaline-finish methacrylate

* ROSONE / CANOPY

Informazioni Tecniche vai a pag. 455
Technical info go to page 455

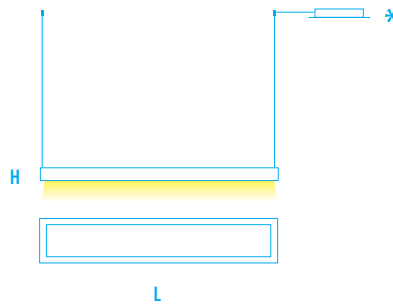

2137/S140-1

W 53 - Vac 230

Lm 3.400

M 2.700°K

C 3.000°K - W 4.000°K

L 1400 x 165 mm

H 35 mm

L CAVI / CABLES 1.800 mm

DIMMERABILE / DIMMABLE

2137/S140-1 - D4

Taglio di fase / Phase Cut

2137/S140-1 - D6

1-10V - DALI - PUSH

2137/S140-1 - D7

ZigBee

2137/S140-1 - D8

CASAMBI

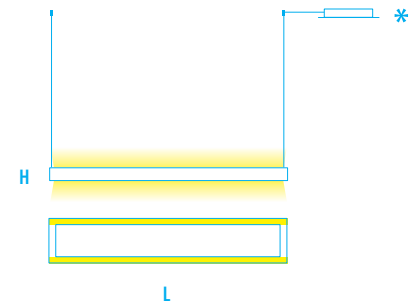

2137/S140-2

W 98 - Vac 230

Lm 3.400 (down) 2.800 (up)

M 2.700°K

C 3.000°K - W 4.000°K

L 1400 x 165 mm

H 35 mm

L CAVI / CABLES 1.800 mm

DIMMERABILE / DIMMABLE

2137/S140-2 - D4

Taglio di fase / Phase Cut

2137/S140-2 - D6

1-10V - DALI - PUSH

2137/S140-2 - D7

ZigBee

2137/S140-2 - D8

CASAMBI

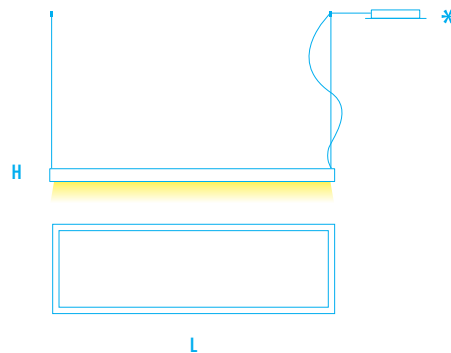

2138/S141-1

W 57 - Vac 230

Lm 3.600

M 2.700°K

C 3.000°K - W 4.000°K

L 1.410 x 290 mm

H 35 mm

L CAVI / CABLES 2.000 mm

DIMMERABILE / DIMMABLE

2138/S141-1 - D4

Taglio di fase / Phase Cut

2138/S141-1 - D6

1-10V - DALI - PUSH

2138/S141-1 - D7

ZigBee

2138/S141-1 - D8

CASAMBI

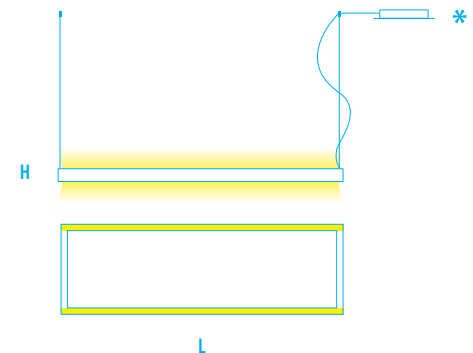

2138/S141-2

W 99 - Vac 230

Lm 3.600 (down) 2.650 (up)

M 2.700°K

C 3.000°K - W 4.000°K

L 1.410 x 290 mm

H 35 mm

L CAVI / CABLES 2.000 mm

DIMMERABILE / DIMMABLE

2138/S141-2 - D4

Taglio di fase / Phase Cut

2138/S141-2 - D6

1-10V - DALI - PUSH

2138/S141-2 - D7

ZigBee

2138/S141-2 - D8

CASAMBI

128

10
Bianco
White



13
Foglia Argento
Silver Leaf



14
Foglia Oro
Gold Leaf



15
Grigio
Grey



19
Nero
Black



21
Grigio tortora
Dove grey



22
Foglia rame
Copper leaf



23
Ruggine
Rust



24
Ferro
Iron



28
Oro
Gold



34
Rosè Verniciato
Painted Rosè



35
Bronzo Verniciato
Bronze Painted



BICOLORE / TWO-TONE

Vai a pagina / Go to page 454

19
Nero
Black
/



24
Ferro
Iron
/



10
Bianco
White
/



14
Foglia Oro
Gold Leaf



13
Foglia Argento
Silver Leaf



22
Foglia rame
Copper leaf







FLAT

CRI > 80

DIMMERABILE / DIMMABLE

Vai a pagina / Go to page 457

DIFFUSORE / DIFFUSER

Metacrilato opalino

Opaline-finish methacrylate

10 Bianco
White



13 Foglia Argento
Silver Leaf



14 Foglia Oro
Gold Leaf



15 Grigio
Grey



19 Nero
Black



21 Grigio tortora
Dove grey



22 Foglia rame
Copper leaf



23 Ruggine
Rust



24 Ferro
Iron



28 Oro
Gold



34 Rosè Verniciato
Painted Rosè



35 Bronzo Verniciato
Bronze Painted



BICOLORE / TWO-TONE

Vai a pagina / Go to page 454

19 Nero
Black



24 Ferro
Iron



10 Bianco
White



14 Foglia Oro
Gold Leaf



13 Foglia Argento
Silver Leaf



22 Foglia rame
Copper leaf

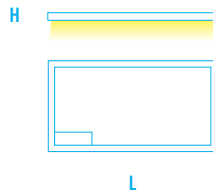

2138/PL-79

W 38 - Vac 230

Lm 2.400

M 2.700°K

C 3.000°K - W 4.000°K

L 790 x 390 mm

H 35 mm

DIMMERABILE / DIMMABLE

2138/PL-79 - D4

Taglio di fase / Phase Cut

2138/PL-79 - D6

1-10V - DALI - PUSH

2138/PL-79 - D7

ZigBee

2138/PL-79 - D8

CASAMBI

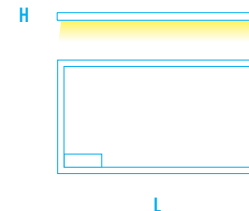

2138/PL-109

W 55 - Vac 230

Lm 3.450

M 2.700°K

C 3.000°K - W 4.000°K

L 1.090 x 540 mm

H 35 mm

DIMMERABILE / DIMMABLE

2138/PL-109 - D4

Taglio di fase / Phase Cut

2138/PL-109 - D6

1-10V - DALI - PUSH

2138/PL-109 - D7

ZigBee

2138/PL-109 - D8

CASAMBI

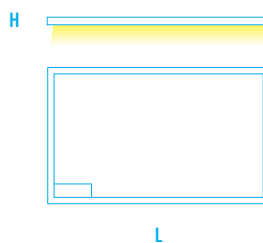

2138/PL-129

W 65 - Vac 230

Lm 4.100

M 2.700°K

C 3.000°K - W 4.000°K

L 1.290 x 640 mm

H 35 mm

DIMMERABILE / DIMMABLE

2138/PL-129 - D4

Taglio di fase / Phase Cut

2138/PL-129 - D6

1-10V - DALI - PUSH

2138/PL-129 - D7

ZigBee

2138/PL-129 - D8

CASAMBI

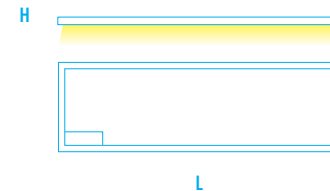

2138/PL-141

W 57 - Vac 230

Lm 3.600

M 2.700°K

C 3.000°K - W 4.000°K

L 1.410 x 290 mm

H 35 mm

DIMMERABILE / DIMMABLE

2138/PL-141 - D4

Taglio di fase / Phase Cut

2138/PL-141 - D6

1-10V - DALI - PUSH

2138/PL-141 - D7

ZigBee

2138/PL-141 - D8

CASAMBI

FLAT

CRI > 80

DIMMERABILE / DIMMABLE

Vai a pagina / Go to page 457

DIFFUSORE / DIFFUSER

Metacrilato opalino

Opaline-finish methacrylate



2136/R1-60

Rosone con alimentatore 60W
Base with power supply 60W

BASE 320 x 100 mm
L 360 x 140 mm
H 45 mm

DIMMERABILE / DIMMABLE

2136/R1-60 - D4

Taglio di fase / Phase Cut

2136/R1-60 - D6

1-10V - DALI - PUSH

2136/R1-60 - D7

ZigBee

2136/R1-60 - D8

CASAMBI



2136/R1-100

Rosone con alimentatore 100W
Base with power supply 100W

BASE 320 x 100 mm
L 360 x 140 mm
H 45 mm

DIMMERABILE / DIMMABLE

2136/R1-100 - D4

Taglio di fase / Phase Cut

2136/R1-100 - D6

1-10V - DALI - PUSH

2136/R1-100 - D7

ZigBee

2136/R1-100 - D8

CASAMBI

132

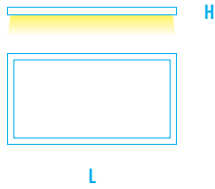

2138/TR-79

W 38 - **Vdc** 24

Lm 3.700

M 2.700°K

C 3.000°K - **W** 4.000°K

L 790 x 390 mm

H 35 mm

ALIMENTATORE REMOTO
REMOTE POWER SUPPLY

ON/OFF

AL. 60-24

DIMMERABILE / DIMMABLE

AL.50-24 - D4

Taglio di fase / Phase Cut

AL.60-24 - D6

1-10V - DALI - PUSH

AL.60-24 - D7

ZigBee

AL.60-24 - D8

CASAMBI

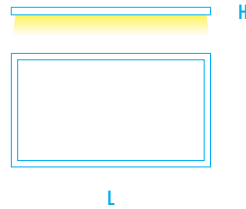

2138/TR-109

W 55 - **Vdc** 24

Lm 3.450

M 2.700°K

C 3.000°K - **W** 4.000°K

L 1.090 x 540 mm

H 35 mm

ALIMENTATORE REMOTO
REMOTE POWER SUPPLY

ON/OFF

AL. 60-24

DIMMERABILE / DIMMABLE

AL.75-24 - D4

Taglio di fase / Phase Cut

AL.60-24 - D6

1-10V - DALI - PUSH

AL.60-24 - D7

ZigBee

AL.60-24 - D8

CASAMBI

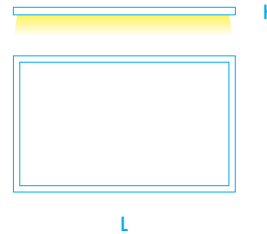

2138/TR-129

W 65 - **Vdc** 24

Lm 4.100

M 2.700°K

C 3.000°K - **W** 4.000°K

L 1.290 x 640 mm

H 35 mm

ALIMENTATORE REMOTO
REMOTE POWER SUPPLY

ON/OFF

AL. 100-24

DIMMERABILE / DIMMABLE

AL.75-24 - D4

Taglio di fase / Phase Cut

AL.100-24 - D6

1-10V - DALI - PUSH

AL.100-24 - D7

ZigBee

AL.100-24 - D8

CASAMBI

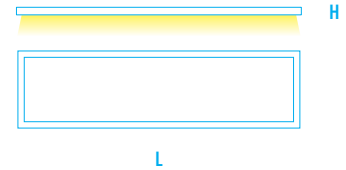

2138/TR-141

W 57 - **Vdc** 24

Lm 3.600

M 2.700°K

C 3.000°K - **W** 4.000°K

L 1.410 x 290 mm

H 35 mm

ALIMENTATORE REMOTO
REMOTE POWER SUPPLY

ON/OFF

AL. 60-24

DIMMERABILE / DIMMABLE

AL.75-24 - D4

Taglio di fase / Phase Cut

AL.60-24 - D6

1-10V - DALI - PUSH

AL.60-24 - D7

ZigBee

AL.60-24 - D8

CASAMBI

10

Bianco
White



13

Foglia Argento
Silver Leaf



14

Foglia Oro
Gold Leaf



15

Grigio
Grey



19

Nero
Black



21

Grigio tortora
Dove grey



28

Oro
Gold



22

Foglia rame
Copper leaf



23

Ruggine
Rust



24

Ferro
Iron



34

Rosè Verniciato
Painted Rosè



35

Bronzo Verniciato
Bronze Painted



BICOLORE / TWO-TONE

Vai a pagina / Go to page 454

19

Nero
Black

/

14

Foglia Oro
Gold Leaf



24

Ferro
Iron

/

13

Foglia Argento
Silver Leaf



10

Bianco
White

/

22

Foglia rame
Copper leaf





FLAT



FLAT

CRI > 80

DIMMERABILE / DIMMABLE

Vai a pagina / Go to page 457

DIFFUSORE / DIFFUSER

Metacrilato opalino
Opaline-finish methacrylate



2136/R1-60

Rosone con alimentatore 60W
Base with power supply 60W

BASE 320 x 100 mm
L 360 x 140 mm
H 45 mm

DIMMERABILE / DIMMABLE

2136/R1-60 - D4
Taglio di fase / Phase Cut

2136/R1-60 - D6
1-10V - DALI - PUSH

2136/R1-60 - D7
ZigBee

2136/R1-60 - D8
CASAMBI



2136/R1-100

Rosone con alimentatore 100W
Base with power supply 100W

BASE 320 x 100 mm
L 360 x 140 mm
H 45 mm

DIMMERABILE / DIMMABLE

2136/R1-100 - D4
Taglio di fase / Phase Cut

2136/R1-100 - D6
1-10V - DALI - PUSH

2136/R1-100 - D7
ZigBee

2136/R1-100 - D8
CASAMBI

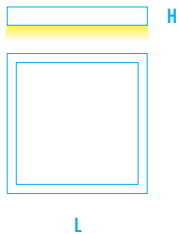

2137/TR55

W 36 - Vdc 24

Lm 2.300
M 2.700°K
C 3.000°K - W 4.000°K

L 550 x 550 mm
H 35 mm

ALIMENTATORE REMOTO
REMOTE POWER SUPPLY

ON-OFF
AL.60-24

DIMMERABILE / DIMMABLE

AL.50-24 - D4
Taglio di fase / Phase Cut

AL.60-24 - D6
1-10V - DALI - PUSH

AL.60-24 - D7
ZigBee

AL.60-24 - D8
CASAMBI

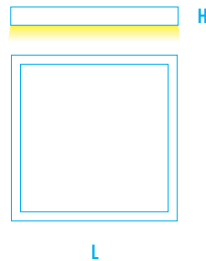

2137/TR75

W 51 - Vdc 24

Lm 3.200
M 2.700°K
C 3.000°K - W 4.000°K

L 750 x 750 mm
H 35 mm

ALIMENTATORE REMOTO
REMOTE POWER SUPPLY

ON-OFF
AL.60-24

DIMMERABILE / DIMMABLE

AL.75-24 - D4
Taglio di fase / Phase Cut

AL.60-24 - D6
1-10V - DALI - PUSH

AL.60-24 - D7
ZigBee

AL.60-24 - D8
CASAMBI

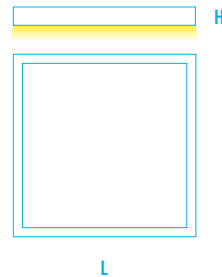

2137/TR90

W 62 - Vdc 24

Lm 3.900
M 2.700°K
C 3.000°K - W 4.000°K

L 900 x 900 mm
H 35 mm

ALIMENTATORE REMOTO
REMOTE POWER SUPPLY

ON-OFF
AL.100-24

DIMMERABILE / DIMMABLE

AL.75-24 - D4
Taglio di fase / Phase Cut

AL.100-24 - D6
1-10V - DALI - PUSH

AL.100-24 - D7
ZigBee

AL.100-24 - D8
CASAMBI

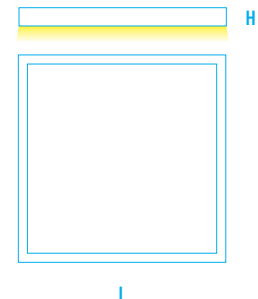

2137/TR120

W 82 - Vdc 24

Lm 5.200
M 2.700°K
C 3.000°K - W 4.000°K

L 1200 x 1200 mm
H 35 mm

ALIMENTATORE REMOTO
REMOTE POWER SUPPLY

ON-OFF
AL.100-24

DIMMERABILE / DIMMABLE

AL.100-24 - D4
Taglio di fase / Phase Cut

AL.100-24 - D6
1-10V - DALI - PUSH

AL.100-24 - D7
ZigBee

AL.100-24 - D8
CASAMBI

| | | | | | |
|------------------------------|--|--------------------------------------|-----------------------------|--|--|
| 10 Bianco White | 13 Foglia Argento Silver Leaf | 14 Foglia Oro Gold Leaf | 15 Grigio Grey | 19 Nero Black | 21 Grigio tortora Dove grey |
| | | | | | |
| 28 Oro Gold | 22 Foglia rame Copper leaf | 23 Ruggine Rust | 24 Ferro Iron | 34 Rosè Verniciato Painted Rosè | 35 Bronzo Verniciato Bronze Painted |
| | | | | | |

BICOLORE / TWO-TONE
Vai a pagina / Go to page 454

| | | |
|--------------------------------------|--|---|
| 19 Nero Black | 24 Ferro Iron | 10 Bianco White |
| | | |
| 14 Foglia Oro Gold Leaf | 13 Foglia Argento Silver Leaf | 22 Foglia rame Copper leaf |
| | | |





FLAT

2136/S110

FLAT

CRI > 80

DIMMERABILE / DIMMABLE

Vai a pagina / Go to page 457

DIFFUSORE / DIFFUSER

Metacrilato opalino
Opaline-finish methacrylate

* ROSONE / CANOPY

Informazioni Tecniche vai a pag. 455
Technical info go to page 455

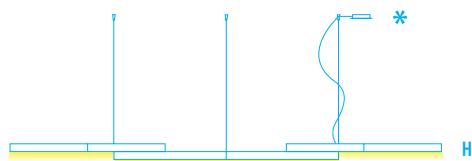

L2

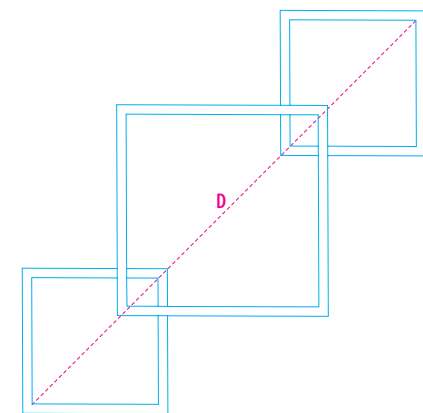
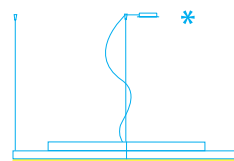

L2

2136/S110-1

W 85 - Vac 230

Lm 5.300

M 2.700°K

C 3.000°K - W 4.000°K

L1 1100 mm

L2 1100 mm

D 1480 mm

H 65 mm

L CAVI / CABLES 2000 mm

DIMMERABILE / DIMMABLE

2136/S110-1 - D4

Taglio di fase / Phase Cut

2136/S110-1 - D6

1-10V - DALI - PUSH

2136/S110-1 - D7

ZigBee

2136/S110-1 - D8

CASAMBI

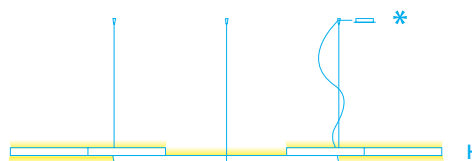

L

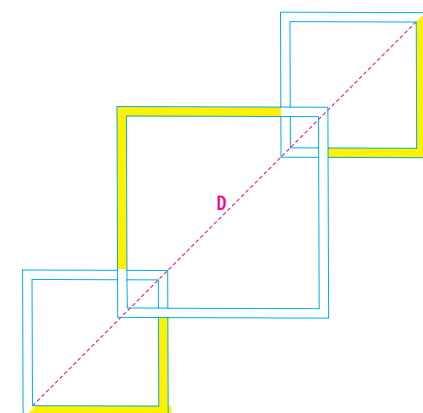
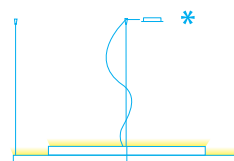

L2

2136/S110-2

W 119 - Vac 230

Lm 5.300 (down) 2.100 (up)

M 2.700°K

C 3.000°K - W 4.000°K

L1 1100 mm

L2 1100 mm

D 1480 mm

H 65 mm

L CAVI / CABLES 2000 mm

DIMMERABILE / DIMMABLE

2136/S110-2 - D4

Taglio di fase / Phase Cut

2136/S110-2 - D6

1-10V - DALI - PUSH

2136/S110-2 - D7

ZigBee

2136/S110-2 - D8

CASAMBI

10

Bianco
White



13

Foglia Argento
Silver Leaf



14

Foglia Oro
Gold Leaf



15

Grigio
Grey



19

Nero
Black



21

Grigio tortora
Dove grey



28

Oro
Gold



22

Foglia rame
Copper leaf



23

Ruggine
Rust



24

Ferro
Iron



34

Rosè Verniciato
Painted Rosè



35

Bronzo Verniciato
Bronze Painted



BICOLORE / TWO-TONE

Vai a pagina / Go to page 454

19

Nero
Black



24

Ferro
Iron



10

Bianco
White



14

Foglia Oro
Gold Leaf



13

Foglia Argento
Silver Leaf



22

Foglia rame
Copper leaf



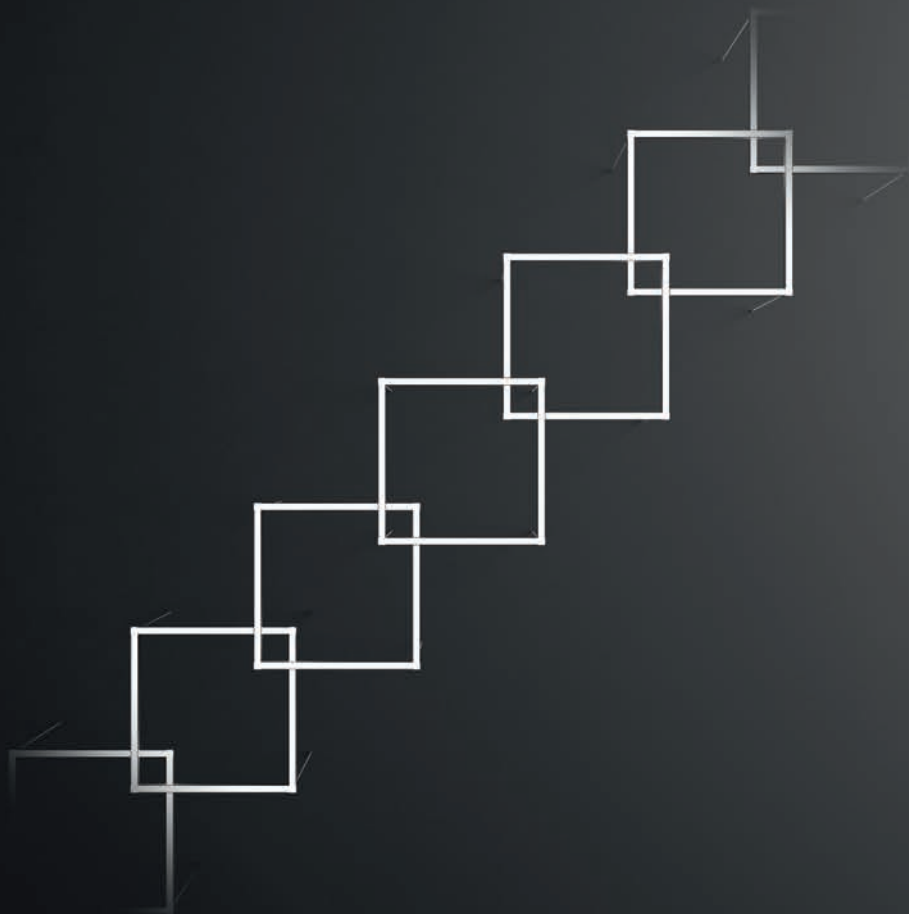
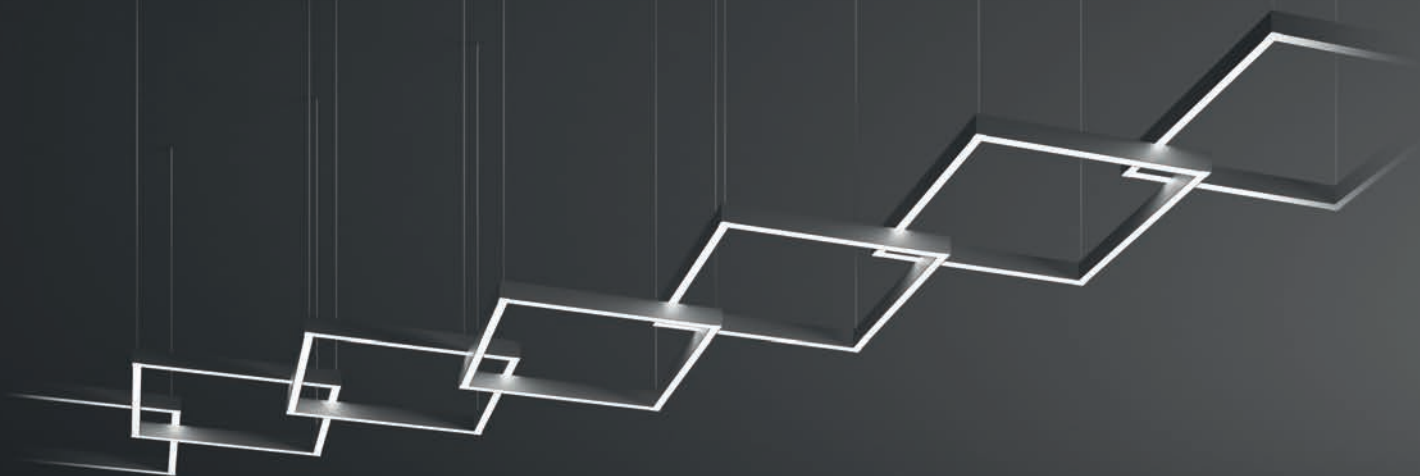

140

SU RICHIESTA COMPOSIZIONI SPECIALI / ON REQUEST SPECIAL COMPOSITIONS
Misure disponibili / Available sizes: 300x300 - 400x400 - 550x550 - 750x750 - 900x900 - 1.200x1.200

FLAT

CRI > 80

DIMMERABILE / DIMMABLE

Vai a pagina / Go to page 457

DIFFUSORE / DIFFUSER

Metacrilato opalino

Opaline-finish methacrylate

*** ROSONE / CANOPY**

Informazioni Tecniche vai a pag. 455

Technical info go to page 455

10
Bianco
White



13
Foglia Argento
Silver Leaf



14
Foglia Oro
Gold Leaf



15
Grigio
Grey



19
Nero
Black



21
Grigio tortora
Dove grey



28
Oro
Gold



22
Foglia rame
Copper leaf



23
Ruggine
Rust



24
Ferro
Iron



34
Rosè Verniciato
Painted Rosè



35
Bronzo Verniciato
Bronze Painted



BICOLORE / TWO-TONE

Vai a pagina / Go to page 454

19
Nero
Black
/



24
Ferro
Iron
/



10
Bianco
White
/



14
Foglia Oro
Gold Leaf



13
Foglia Argento
Silver Leaf



22
Foglia rame
Copper leaf

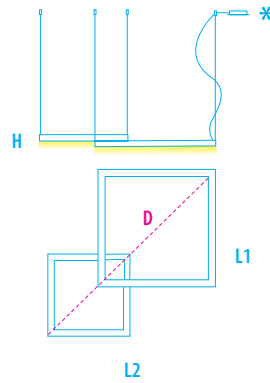

2136/S65-1

W 50 - Vac 230

Lm 3.150

M 2.700°K

C 3.000°K - W 4.000°K

L1 650 mm

L2 650 mm

D 900 mm

H 65 mm

L CAVI / CABLES 2000 mm

DIMMERABILE / DIMMABLE

2136/S65-1 - D4

Taglio di fase / Phase Cut

2136/S65-1 - D6

1-10V - DALI - PUSH

2136/S65-1 - D7

ZigBee

2136/S65-1 - D8

CASAMBI

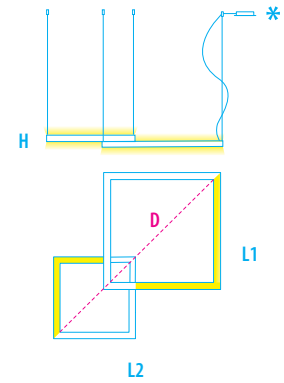

2136/S65-2

W 70 - Vac 230

Lm 3.150 (down) 1.250 (up)

M 2.700°K

C 3.000°K - W 4.000°K

L1 650 mm

L2 650 mm

D 900 mm

H 65 mm

L CAVI / CABLES 2000 mm

DIMMERABILE / DIMMABLE

2136/S65-2 - D4

Taglio di fase / Phase Cut

2136/S65-2 - D6

1-10V - DALI - PUSH

2136/S65-2 - D7

ZigBee

2136/S65-2 - D8

CASAMBI

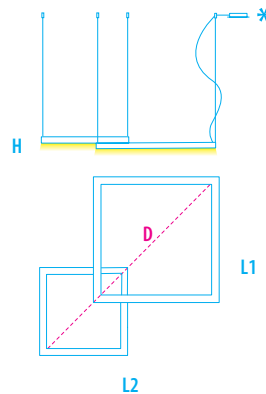

2136/S80-1

W 60 - Vac 230

Lm 3.800

M 2.700°K

C 3.000°K - W 4.000°K

L1 800 mm

L2 800 mm

D 1160 mm

H 65 mm

L CAVI / CABLES 2000 mm

DIMMERABILE / DIMMABLE

2136/S80-1 - D4

Taglio di fase / Phase Cut

2136/S80-1 - D6

1-10V - DALI - PUSH

2136/S80-1 - D7

ZigBee

2136/S80-1 - D8

CASAMBI

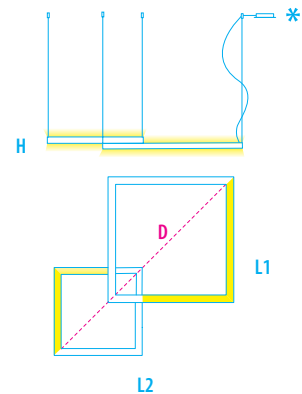

2136/S80-2

W 85 - Vac 230

Lm 3.800 (down) 1.600 (up)

M 2.700°K

C 3.000°K - W 4.000°K

L1 800 mm

L2 800 mm

D 1160 mm

H 65 mm

L CAVI / CABLES 2000 mm

DIMMERABILE / DIMMABLE

2136/S80-2 - D4

Taglio di fase / Phase Cut

2136/S80-2 - D6

1-10V - DALI - PUSH

2136/S80-2 - D7

ZigBee

2136/S80-2 - D8

CASAMBI



142



2136/TR110

BRAGA LED

FLAT

CRI > 80

DIMMERABILE / DIMMABLE

Vai a pagina / Go to page 457

DIFFUSORE / DIFFUSER

Metacrilato opalino

Opaline-finish methacrylate

*** ROSONE / CANOPY**

Informazioni Tecniche vai a pag. 455

Technical info go to page 455

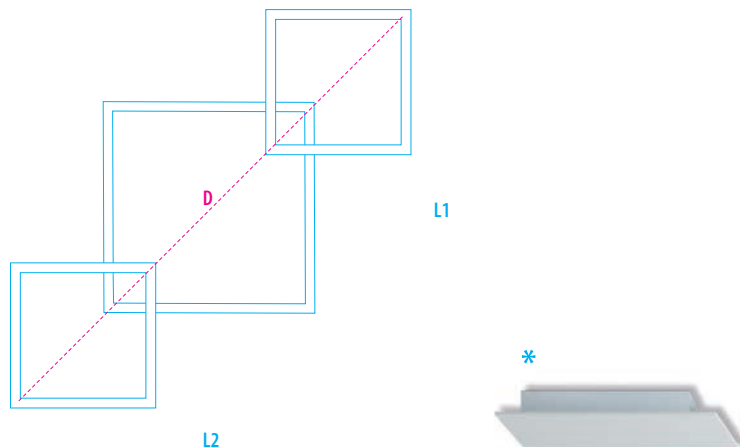

2136/TR110

W 85 - Vdc 24

Lm 5.300

M 2.700°K

C 3.000°K - W 4.000°K

L1 1100 mm

L2 1100 mm

D 1480 mm

H 65 mm

ALIMENTATORE REMOTO
REMOTE POWER SUPPLY

ON/OFF

AL. 100-24

DIMMERABILE / DIMMABLE

AL.100-24 - D4

Taglio di fase / Phase Cut

AL.100-24 - D6

1-10V - DALI - PUSH

AL.100-24 - D7

ZigBee

AL.100-24 - D8

CASAMBI

2136/R1-100

Rosone con alimentatore 100W

Base with power supply 100W

BASE 320 x 100 mm

L 360 x 140 mm

H 45 mm

DIMMERABILE / DIMMABLE

2136/R1-100 - D4

Taglio di fase / Phase Cut

2136/R1-100 - D6

1-10V - DALI - PUSH

2136/R1-100 - D7

ZigBee

2136/R1-100 - D8

CASAMBI

| | | | | | |
|------------------------------|--|--------------------------------------|-----------------------------|--|--|
| 10 Bianco White | 13 Foglia Argento Silver Leaf | 14 Foglia Oro Gold Leaf | 15 Grigio Grey | 19 Nero Black | 21 Grigio tortora Dove grey |
| | | | | | |
| 28 Oro Gold | 22 Foglia rame Copper leaf | 23 Ruggine Rust | 24 Ferro Iron | 34 Rosè Verniciato Painted Rosè | 35 Bronzo Verniciato Bronze Painted |
| | | | | | |

BICOLORE / TWO-TONE

Vai a pagina / Go to page 454

| | | |
|--------------------------------------|--|---|
| 19 Nero Black / | 24 Ferro Iron / | 10 Bianco White / |
| | | |
| 14 Foglia Oro Gold Leaf | 13 Foglia Argento Silver Leaf | 22 Foglia rame Copper leaf |
| | | |



144

2136/PL60

BRAGA LED



145

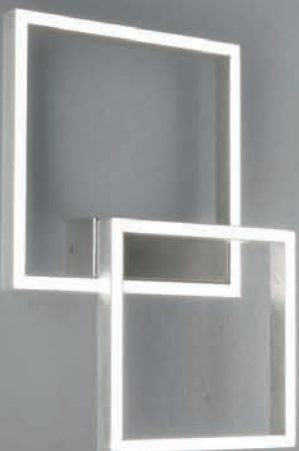

FLAT

2136/PL75

FLAT

CRI > 80

DIMMERABILE / DIMMABLE

Vai a pagina / Go to page 457

DIFFUSORE / DIFFUSER

Metacrilato opalino

Opaline-finish methacrylate

146

10 Bianco
White



13 Foglia Argento
Silver Leaf



14 Foglia Oro
Gold Leaf



15 Grigio
Grey



19 Nero
Black



21 Grigio tortora
Dove grey



28 Oro
Gold



22 Foglia rame
Copper leaf



23 Ruggine
Rust



24 Ferro
Iron



34 Rosè Verniciato
Painted Rosè



35 Bronzo Verniciato
Bronze Painted



BICOLORE / TWO-TONE

Vai a pagina / Go to page 454

19 Nero
Black
/



24 Ferro
Iron
/



10 Bianco
White
/



14 Foglia Oro
Gold Leaf



13 Foglia Argento
Silver Leaf



22 Foglia rame
Copper leaf

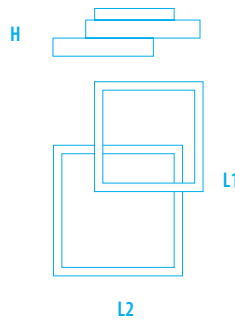

2136/PL50

W 40 - Vac 230

Lm 2.500

M 2.700°K

C 3.000°K - W 4.000°K

L1 540 mm

L2 410 mm

H 100 mm

DIMMERABILE / DIMMABLE

2136/PL50 - D4

Taglio di fase / Phase Cut

2136/PL50 - D6

1-10V - DALI - PUSH

2136/PL50 - D7 ZigBee

2136/PL50 - D8 CASAMBI

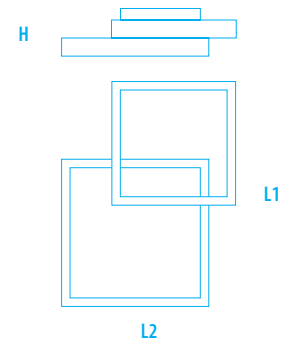

2136/PL60

W 45 - Vac 230

Lm 2.800

M 2.700°K

C 3.000°K - W 4.000°K

L1 600 mm

L2 500 mm

H 100 mm

DIMMERABILE / DIMMABLE

2136/PL60 - D4

Taglio di fase / Phase Cut

2136/PL60 - D6

1-10V - DALI - PUSH

2136/PL60 - D7 ZigBee

2136/PL60 - D8 CASAMBI

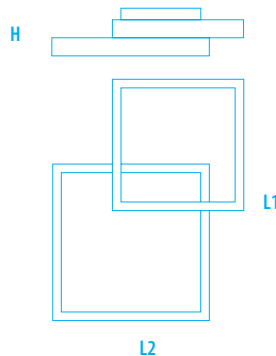

2136/PL75

W 55 - Vac 230

Lm 3.450

M 2.700°K

C 3.000°K - W 4.000°K

L1 750 mm

L2 650 mm

H 100 mm

DIMMERABILE / DIMMABLE

2136/PL75 - D4

Taglio di fase / Phase Cut

2136/PL75 - D6

1-10V - DALI - PUSH

2136/PL75 - D7 ZigBee

2136/PL75 - D8 CASAMBI

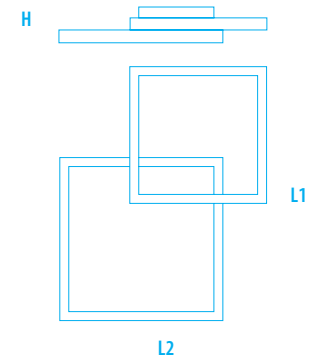

2136/PL90

W 66 - Vac 230

Lm 4.200

M 2.700°K

C 3.000°K - W 4.000°K

L1 900 mm

L2 800 mm

H 100 mm

DIMMERABILE / DIMMABLE

2136/PL90 - D4

Taglio di fase / Phase Cut

2136/PL90 - D6

1-10V - DALI - PUSH

2136/PL90 - D7 ZigBee

2136/PL90 - D8 CASAMBI



GRANDE MIGRAZIONE
La fotografia in cento immagini
Signs

GEORGE PLATTON
THE TIMES



150



2136/A25

BRAGA LED

FLAT

CRI > 80

DIMMERABILE / DIMMABLE

Vai a pagina / Go to page 457

DIFFUSORE / DIFFUSER

Metacrilato opalino

Opaline-finish methacrylate

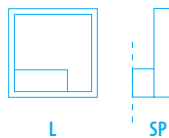

2137/AP20

W 12 - Vac 230

Lm 750

M 2.700°K

C 3.000°K - W 4.000°K

L 200 x 200 mm

SP 85 mm

DIMMERABILE / DIMMABLE

2137/AP20 - D6

1-10V - DALI - PUSH

2137/AP20 - D8

CASAMBI

151

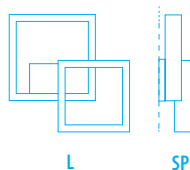

2136/A25

W 19 - Vac 230

Lm 1.200

M 2.700°K

C 3.000°K - W 4.000°K

L 250 x 250 mm

SP 80 mm

DIMMERABILE / DIMMABLE

2136/A25 - D6

1-10V - DALI - PUSH

2136/A25 - D8

CASAMBI

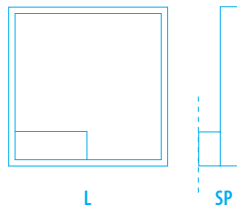

2137/AP45

W 31 - Vac 230

Lm 1.900

M 2.700°K

C 3.000°K - W 4.000°K

L 450 x 450 mm

SP 75 mm

DIMMERABILE / DIMMABLE

2137/AP45 - D4

Taglio di fase / Phase Cut

2137/AP45 - D6

1-10V - DALI - PUSH

2137/AP45 - D7

ZigBee

2137/AP45 - D8

CASAMBI

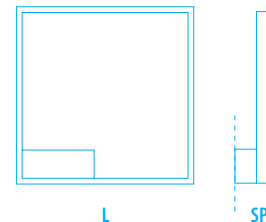

2137/AP54

W 36 - Vac 230

Lm 2.300

M 2.700°K

C 3.000°K - W 4.000°K

L 540 x 540 mm

SP 75 mm

DIMMERABILE / DIMMABLE

2137/AP54 - D4

Taglio di fase / Phase Cut

2137/AP54 - D6

1-10V - DALI - PUSH

2137/AP54 - D7

ZigBee

2137/AP54 - D8

CASAMBI

10

Bianco
White



13

Foglia Argento
Silver Leaf



14

Foglia Oro
Gold Leaf



15

Grigio
Grey



19

Nero
Black



21

Grigio tortora
Dove grey



28

Oro
Gold



22

Foglia rame
Copper leaf



23

Ruggine
Rust



24

Ferro
Iron



34

Rosè Verniciato
Painted Rosè



35

Bronzo Verniciato
Bronze Painted



BICOLORE / TWO-TONE

Vai a pagina / Go to page 454

19

Nero
Black

/

/

14

Foglia Oro
Gold Leaf



24

Ferro
Iron

/

/

13

Foglia Argento
Silver Leaf



10

Bianco
White

/

/

22

Foglia rame
Copper leaf



152



2136/T

BRAGA LED

FLAT

CRI > 80

DIFFUSORE / DIFFUSER

Metacrilato opalino

Opaline-finish methacrylate

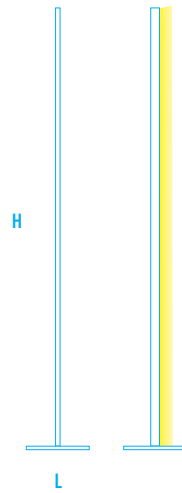
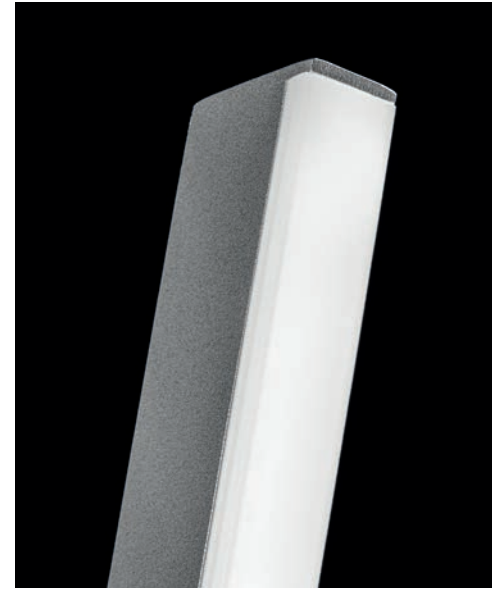

2136/T

W 34 - Vac 230

Lm 2.200

M 2.700°K

C 3.000°K - W 4.000°K

L 20 x 40 mm

H 1.950 mm

BASE 210 x 210 mm

TOUCH DIMMER

| | | | | | |
|-------------------------------------|---|---|------------------------------------|---|---|
| 10 Bianco <i>White</i> | 13 Foglia Argento <i>Silver Leaf</i> | 14 Foglia Oro <i>Gold Leaf</i> | 15 Grigio <i>Grey</i> | 19 Nero <i>Black</i> | 21 Grigio tortora <i>Dove grey</i> |
| | | | | | |
| 28 Oro <i>Gold</i> | 22 Foglia rame <i>Copper leaf</i> | 23 Ruggine <i>Rust</i> | 24 Ferro <i>Iron</i> | 34 Rosè Verniciato <i>Painted Rosè</i> | 35 Bronzo Verniciato <i>Bronze Painted</i> |
| | | | | | |

FLAT

CRI > 80

DIFFUSORE / DIFFUSER

Metacrilato opalino

Opaline-finish methacrylate

154

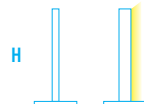

L

2136/L

W 4 - Vac 230

Lm 250

M 2.700°K

C 3.000°K - W 4.000°K

L 20 x 40 mm

H 250 mm

BASE 80 x 80 mm

10

Bianco
White



13

Foglia Argento
Silver Leaf



14

Foglia Oro
Gold Leaf



15

Grigio
Grey



19

Nero
Black



21

Grigio tortora
Dove grey



28

Oro
Gold



22

Foglia rame
Copper leaf



23

Ruggine
Rust



24

Ferro
Iron



34

Rosè Verniciato
Painted Rosè



35

Bronzo Verniciato
Bronze Painted





Charme

156



2156/S + 2146/PL5

BRAGA LED





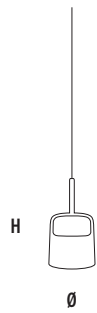

2156/S

1 x max 10W GX53 LED 

Ø 155 mm

H 320 mm

L CAVO / CABLE 3.000 mm

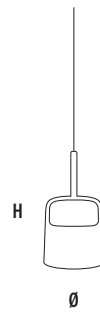

2156/S2

1 x max 10W GX53 LED 

Ø 210 mm

H 400 mm

L CAVO / CABLE 3.000 mm

V5
Cromo
Chrome

V6
Bronzo
Bronze

V7
Viola
Purple

V9
Oro
Gold

V10
Rame
Copper



V4
Trasparente
Transparent





2147/150

L 1.500
L2 30 mm
H 47 mm

Numero di fori per sospensioni su richiesta / Number of holes for pendants on request



2147/50

L 500 mm
L2 30 mm
H 47 mm

2147/100

L 1.000 mm
L2 30 mm
H 47 mm

2147/200

L 2.000 mm
L2 30 mm
H 47 mm

2147/250

L 2.500 mm
L2 30 mm
H 47 mm

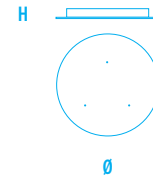

2146/PL30

Ø 300 mm
H 37 mm

160

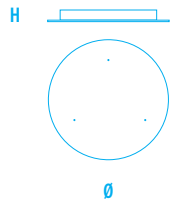

2146/PL3

Ø 440 mm
H 60 mm

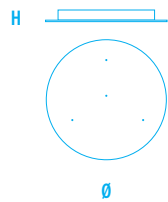

2146/PL4

Ø 440 mm
H 60 mm

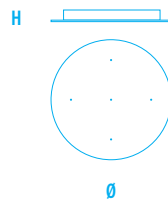

2146/PL5

Ø 440 mm
H 60 mm

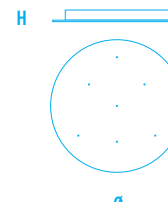

2146/PL7

Ø 560 mm
H 60 mm

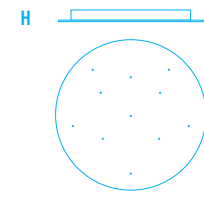

2146/PL11

Ø 700 mm
H 60 mm



2146/N

Ø 20 mm
H 15 mm

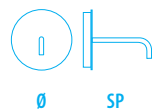

2146/A

Ø 120 mm
SP 150 mm

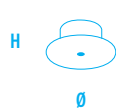

2146/R1

Ø 105 mm
H 30 mm

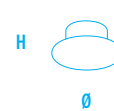

2146/R6

Ø 140 mm
H 30 mm

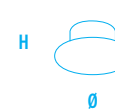

2146/R12

Ø 175 mm
H 30 mm

Rosone per collegamento da 2 a 6
Canopy for connection from 2 to 6

Rosone per collegamento da 2 a 12
Canopy for connection from 2 to 12



Ø

Rosone da incasso
Recessed canopy
Max 3,2 Kg

2146/R35

Ø 45 mm
H 35 mm
Ø 35 mm

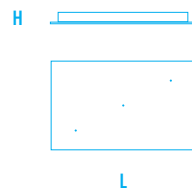

2145/PL50/3

L 530 x 300 mm
H 45 mm

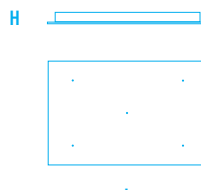

2145/PL80/5

L 800 x 500 mm
H 45 mm

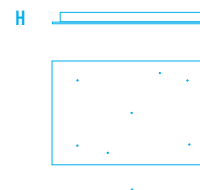

2145/PL80/7

L 800 x 500 mm
H 45 mm

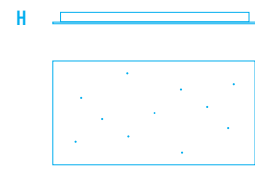

2145/PL110/11

L 1.100 x 500 mm
H 45 mm

10
Bianco
White





Eclettica

162



BRAGA LED





164

2144/S2 + 2144/S3 + 2144/S4 + N°3 2144/S1 + 2145/PL80/7

BRAGA LED



ECLETTICA

2144/S1 + 2144/S2 + 2144/S3 + 2144/S4 + 2146/PL4



BRAGA LED

ECLETTICA

CRI > 80

DIMMERABILE / DIMMABLE

Vai a pagina / Go to page 462

DIFFUSORE / DIFFUSER

Vetro / Glass

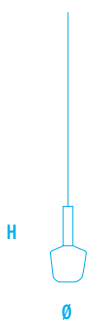

2144/S1

W 1.0 - Vac 230

Lm 900

M 2.700°K

C 3.000°K

Ø 130 mm

H 290 mm

L CAVO / CABLE 3.000 mm

DIMMERABILE / DIMMABLE
TAGLIO DI FASE / PHASE CUT

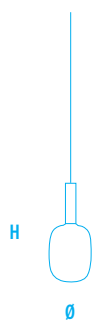

2144/S2

W 1.0 - Vac 230

Lm 900

M 2.700°K

C 3.000°K

Ø 155 mm

H 345 mm

L CAVO / CABLE 3.000 mm

DIMMERABILE / DIMMABLE
TAGLIO DI FASE / PHASE CUT

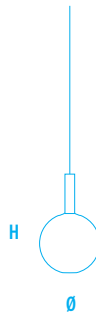

2144/S3

W 1.0 - Vac 230

Lm 900

M 2.700°K

C 3.000°K

Ø 210 mm

H 360 mm

L CAVO / CABLE 3.000 mm

DIMMERABILE / DIMMABLE
TAGLIO DI FASE / PHASE CUT

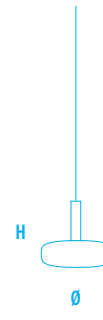

2144/S4

W 1.0 - Vac 230

Lm 900

M 2.700°K

C 3.000°K

Ø 220 mm

H 210 mm

L CAVO / CABLE 3.000 mm

DIMMERABILE / DIMMABLE
TAGLIO DI FASE / PHASE CUT

V4
Trasparente
Transparent

V5
Cromo
Chrome

V6
Bronzo
Bronze

V7
Viola
Purple

V9
Oro
Gold

V10
Rame
Copper



ECLETTICA

DIFFUSORE / DIFFUSER

Vetro / Glass

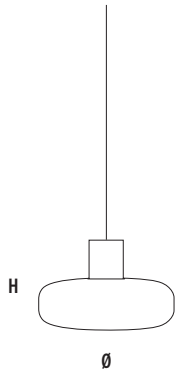

2151/S5

1 x max 70W E27 

o/or
LED

Ø 450 mm
H 260 mm
L CAVO / CABLE 2.000 mm

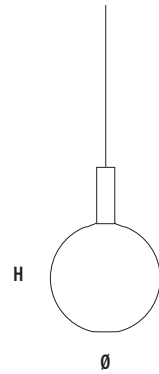

2158/S2

1 x max 70W E27 

o/or
LED

Ø 400 mm
H 550 mm
L CAVO / CABLE 3.000 mm

168



2151/S1

1 x max 42W E14 

o/or
LED

Ø 130 mm
H 290 mm
L CAVO / CABLE 3.000 mm



2151/S2

1 x max 42W E14 

o/or
LED

Ø 155 mm
H 345 mm
L CAVO / CABLE 3.000 mm

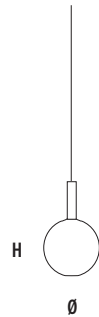

2151/S3

1 x max 42W E14 

o/or
LED

Ø 210 mm
H 360 mm
L CAVO / CABLE 3.000 mm

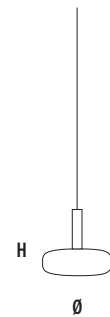

2151/S4

1 x max 42W E14 

o/or
LED

Ø 220 mm
H 210 mm
L CAVO / CABLE 3.000 mm

V4
Trasparente
Transparent

V5
Cromo
Chrome

V6
Bronzo
Bronze

V7
Viola
Purple

V9
Oro
Gold

V10
Rame
Copper









172



2158/S2 + 2146/R1

BRAGA LED



174



2158/T

BRAGA LED

ECLETTICA

DIFFUSORE / DIFFUSER

Vetro / Glass



OFF



ON

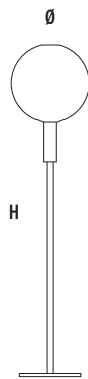

BASE

2158/T

1 x max 70W E27 

o/or

LED

Ø 400 mm

BASE Ø 330 mm

H 1850 mm

V4
Trasparente
Transparent



V5
Cromo
Chrome



V6
Bronzo
Bronze



V7
Viola
Purple



V9
Oro
Gold



V10
Rame
Copper



19
Nero
Black



28
Oro
Gold





2147/150

L 1.500
L2 30 mm
H 47 mm

Numero di fori per sospensioni su richiesta / Number of holes for pendants on request



2147/50

L 500 mm
L2 30 mm
H 47 mm

2147/100

L 1.000 mm
L2 30 mm
H 47 mm

2147/200

L 2.000 mm
L2 30 mm
H 47 mm

2147/250

L 2.500 mm
L2 30 mm
H 47 mm

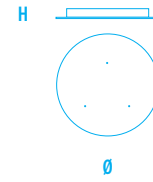

2146/PL30

Ø 300 mm
H 37 mm

176

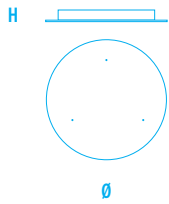

2146/PL3

Ø 440 mm
H 60 mm

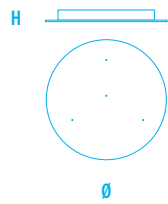

2146/PL4

Ø 440 mm
H 60 mm

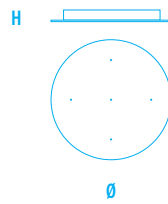

2146/PL5

Ø 440 mm
H 60 mm

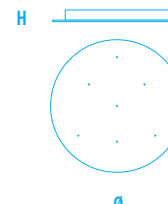

2146/PL7

Ø 560 mm
H 60 mm

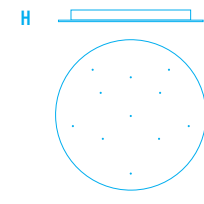

2146/PL11

Ø 700 mm
H 60 mm



2146/N

Ø 20 mm
H 15 mm

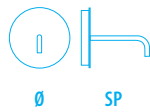

2146/A

Ø 120 mm
SP 150 mm

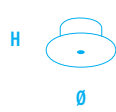

2146/R1

Ø 105 mm
H 30 mm

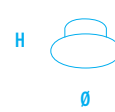

2146/R6

Ø 140 mm
H 30 mm

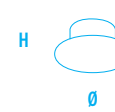

2146/R12

Ø 175 mm
H 30 mm

Rosone per collegamento da 2 a 6
Canopy for connection from 2 to 6

Rosone per collegamento da 2 a 12
Canopy for connection from 2 to 12



Ø

Rosone da incasso
Recessed canopy
Max 3,2 Kg

2146/R35

Ø 45 mm
H 35 mm
Ø 35 mm

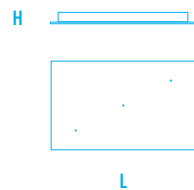

2145/PL50/3

L 530 x 300 mm
H 45 mm

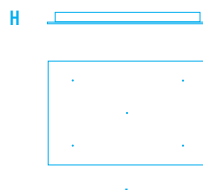

2145/PL80/5

L 800 x 500 mm
H 45 mm

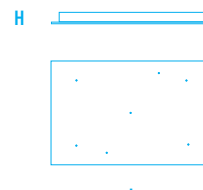

2145/PL80/7

L 800 x 500 mm
H 45 mm

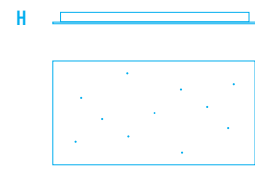

2145/PL110/11

L 1.100 x 500 mm
H 45 mm

10
Bianco
White





178



2151/S1 + 2146/A

BRAGA LED

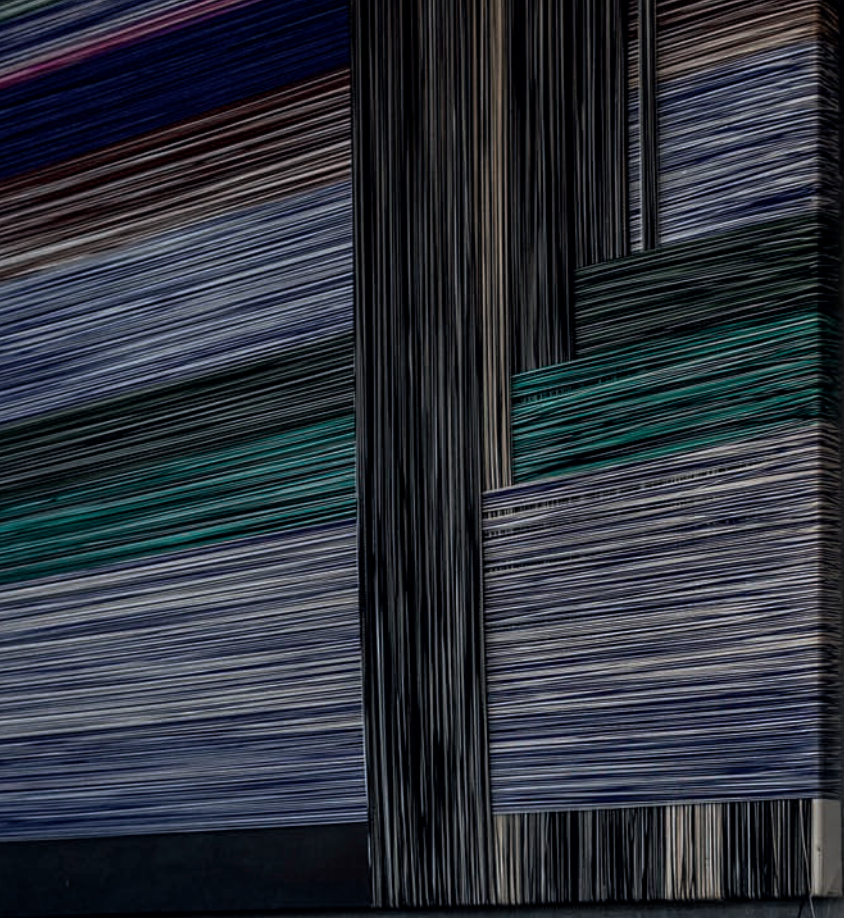

179

Jolie

180



2157/S + 2145/PL80/7

BRAGA LED



182



2157/S + 2147/150

BRAGA LED



JOLIE

DIFFUSORE / DIFFUSER

Vetro / Glass

183

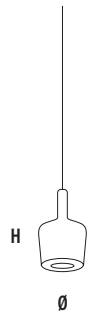

2157/S

1 x max 50W GU10 

o/or

LED

Ø 140 mm

H 260 mm

L CAVO / CABLE 3.000 mm

V11
Bianco
White

V12
Ambra
Amber

V13
Fumè
Fumè

V14
Blu
Blue







2147/150

L 1.500
L2 30 mm
H 47 mm

Numero di fori per sospensioni su richiesta / Number of holes for pendants on request



2147/50

L 500 mm
L2 30 mm
H 47 mm

2147/100

L 1.000 mm
L2 30 mm
H 47 mm

2147/200

L 2.000 mm
L2 30 mm
H 47 mm

2147/250

L 2.500 mm
L2 30 mm
H 47 mm

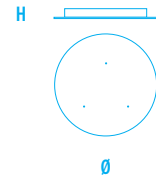

2146/PL30

Ø 300 mm
H 37 mm

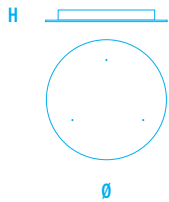

2146/PL3

Ø 440 mm
H 60 mm

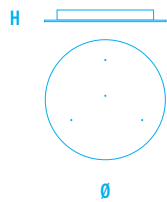

2146/PL4

Ø 440 mm
H 60 mm

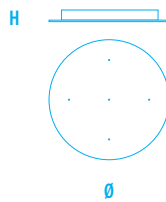

2146/PL5

Ø 440 mm
H 60 mm

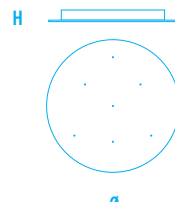

2146/PL7

Ø 560 mm
H 60 mm

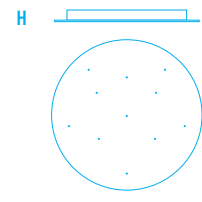

2146/PL11

Ø 700 mm
H 60 mm



2146/N

Ø 20 mm
H 15 mm

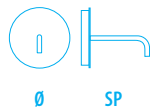

2146/A

Ø 120 mm
SP 150 mm

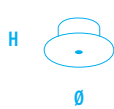

2146/R1

Ø 105 mm
H 30 mm

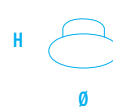

2146/R6

Ø 140 mm
H 30 mm

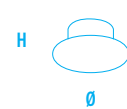

2146/R12

Ø 175 mm
H 30 mm

Rosone per collegamento da 2 a 6
Canopy for connection from 2 to 6

Rosone per collegamento da 2 a 12
Canopy for connection from 2 to 12



Ø

Rosone da incasso
Recessed canopy
Max 3,2 Kg

2146/R35

Ø 45 mm
H 35 mm
Ø 35 mm

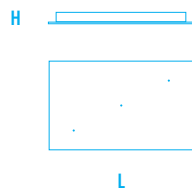

2145/PL50/3

L 530 x 300 mm
H 45 mm

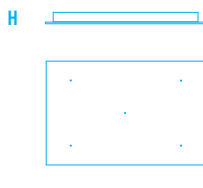

2145/PL80/5

L 800 x 500 mm
H 45 mm

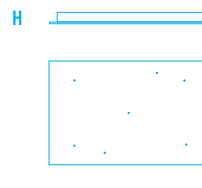

2145/PL80/7

L 800 x 500 mm
H 45 mm

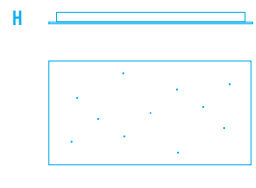

2145/PL110/11

L 1.100 x 500 mm
H 45 mm



Bon ton

186

N°3 2153/1 + 2146/PL3

BRAGA LED





BON TON

DIFFUSORE / DIFFUSER
Vetro / Glass

188

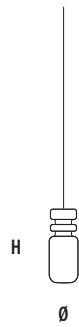

2153/1

1 x max 42W E14 

o/or
LED

Ø 100 mm

H 290 mm

L CAVO / CABLE 3.000 mm



2153/2

1 x max 42W E14 

o/or
LED

Ø 100 mm

H 430 mm

L CAVO / CABLE 3.000 mm

V4
Trasparente
Transparent



V6
Bronzo
Bronze



V7
Viola
Purple



V8
Titanio
Titanium





190



2153/1 + 2146/A

BRAGA LED



2147/150

L 1.500
L2 30 mm
H 47 mm

Numero di fori per sospensioni su richiesta / Number of holes for pendants on request



H
L2

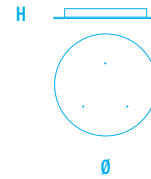

2146/PL30
Ø 300 mm
H 37 mm

2147/50
L 500 mm
L2 30 mm
H 47 mm

2147/100
L 1.000 mm
L2 30 mm
H 47 mm

2147/200
L 2.000 mm
L2 30 mm
H 47 mm

2147/250
L 2.500 mm
L2 30 mm
H 47 mm

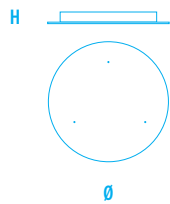

2146/PL3
Ø 440 mm
H 60 mm

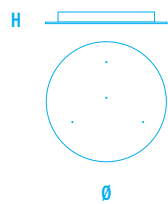

2146/PL4
Ø 440 mm
H 60 mm

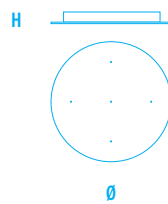

2146/PL5
Ø 440 mm
H 60 mm

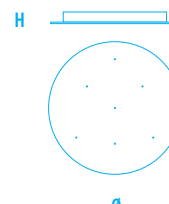

2146/PL7
Ø 560 mm
H 60 mm

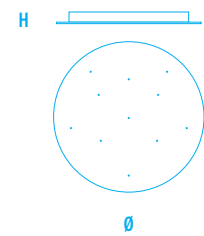

2146/PL11
Ø 700 mm
H 60 mm



2146/N
Ø 20 mm
H 15 mm

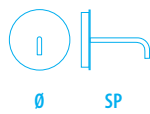

2146/A
Ø 120 mm
SP 150 mm

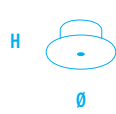

2146/R1
Ø 105 mm
H 30 mm

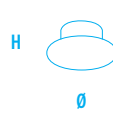

2146/R6
Ø 140 mm
H 30 mm

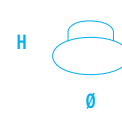

2146/R12
Ø 175 mm
H 30 mm

Rosone per collegamento da 2 a 6
Canopy for connection from 2 to 6

Rosone per collegamento da 2 a 12
Canopy for connection from 2 to 12



Rosone da incasso
Recessed canopy
Max 3,2 Kg

2146/R35
Ø 45 mm
H 35 mm
Ø 35 mm

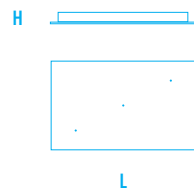

2145/PL50/3
L 530 x 300 mm
H 45 mm

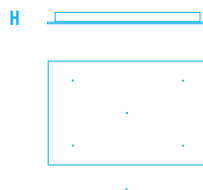

2145/PL80/5
L 800 x 500 mm
H 45 mm

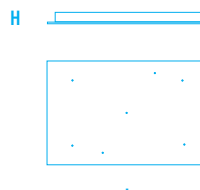

2145/PL80/7
L 800 x 500 mm
H 45 mm

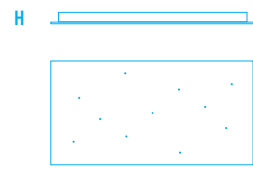

2145/PL110/11
L 1.100 x 500 mm
H 45 mm





192





Syrio

194



2143/S

BRAGA LED

SYRIO

CRI > 80

DIFFUSORE / DIFFUSER

Metacrilato opalino

Opaline-finish methacrylate

* ROSONE / CANOPY

Informazioni Tecniche vai a pag. 455

Technical info go to page 455



195

ROSONE CON CARRUCOLE PER REGOLARE MANUALMENTE L'ALTEZZA DELLA LAMPADA CANOPY WITH ROLLS TO ADJUST MANUALLY PENDANT LAMP HEIGHT

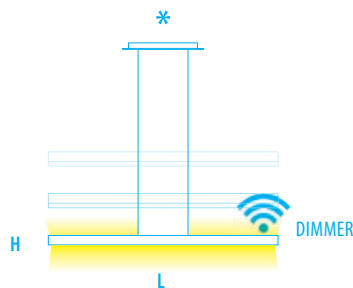

2143/S

W 46 - Vac 230

Lm 1.900 (Down) 1.300 (Up)

M 2.700°K

C 3.000°K - W 4.000°K

L 1.350x24 mm

H 40 mm

L CAVI / CABLES

Min. 700 mm

Max 2.400 mm

**DIMMER OTTICO
OPTICAL DIMMER**

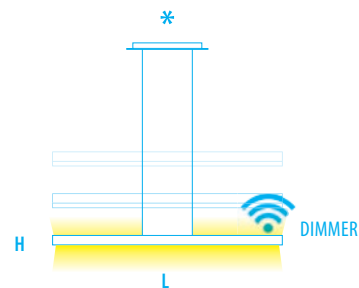

2143/S2

W 56 - Vac 230

Lm 2.300 (Down) 1.700 (Up)

M 2.700°K

C 3.000°K - W 4.000°K

L 1.610x24 mm

H 40 mm

L CAVI / CABLES

Min. 700 mm

Max 2.400 mm

**DIMMER OTTICO
OPTICAL DIMMER**

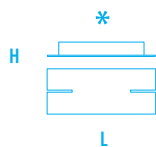

H 45 mm
L 360 x 145 mm

| | | | | | | |
|---|---|---|--|---|---|---|
| 10 Bianco White | 13 Foglia Argento Silver Leaf | 14 Foglia Oro Gold Leaf | 15 Grigio Grey | 19 Nero Black | 22 Foglia rame Copper leaf | 23 Ruggine Rust |
|  |  |  |  |  |  |  |
| 24 Ferro Iron | 27 Ossidato Oxydized | 28 Oro Gold | 30 Gunmetal | 31 Rosé Spaz. Brushed Rosé | 32 Bronzo Spaz. Brush. Bronze | 33 Oro Spaz. Brush. Gold |
|  |  |  |  |  |  |  |

196



2135/S

BRAGA LED

SYRIO

CRI > 80

DIFFUSORE / DIFFUSER

Metacrilato opalino

Opaline-finish methacrylate

* ROSONE / CANOPY

Informazioni Tecniche vai a pag. 455

Technical info go to page 455



Ø

Rosone da incasso

Recessed canopy

Max 3,2 Kg

2146/R35

Ø 45 mm

H 35 mm



Alimentatore Remoto

Remote Power Supply

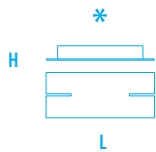

H 45 mm
L 360 x 145 mm

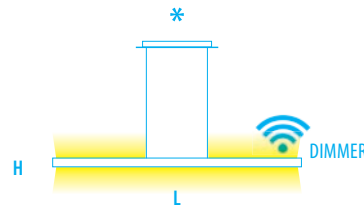

2135/S

W 46 - Vac 230

Lm 1.900 (Down) 1.300 (Up)

M 2.700°K

C 3.000°K - W 4.000°K

L 1.350x24 mm

H 40 mm

L CAVI / CABLES 1.700 mm

**DIMMER OTTICO
OPTICAL DIMMER**

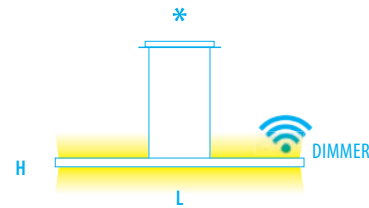

2135/S2

W 56 - Vac 230

Lm 2.300 (Down) 1.700 (Up)

M 2.700°K

C 3.000°K - W 4.000°K

L 1.610x24 mm

H 40 mm

L CAVI / CABLES 1.700 mm

**DIMMER OTTICO
OPTICAL DIMMER**

10

Bianco
White



13

Foglia Argento
Silver Leaf



14

Foglia Oro
Gold Leaf



15

Grigio
Grey



19

Nero
Black



22

Foglia rame
Copper leaf



23

Ruggine
Rust



24

Ferro
Iron



27

Ossidato
Oxydized



28

Oro
Gold



30

Gunmetal



31

Rosé Spaz.
Brushed Rosé



32

Bronzo Spaz.
Brush. Bronze



33

Oro Spaz.
Brush. Gold



Link

198

BRAGA LED



LINK

CRI > 80

DIMMERABILE / DIMMABLE

Vai a pagina / Go to page 457

DIFFUSORE / DIFFUSER

Silicone opalino

Opaline-finish Silicone

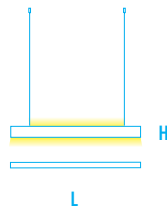

2139/S70

W 19 - Vdc 24

Lm 1050 (down) 400 (up)

M 2.700°K

C 3.000°K - W 4.000°K

L 700 x 20 mm

H 35 mm

L CAVI / CABLES 2.000 mm

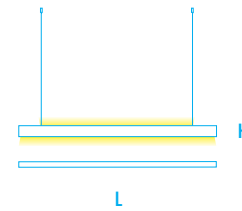

2139/S110

W 34 - Vdc 24

Lm 1.700 (down) 800 (up)

M 2.700°K

C 3.000°K - W 4.000°K

L 1.100 x 20 mm

H 35 mm

L CAVI / CABLES 2.000 mm

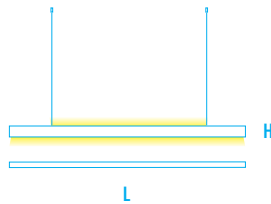

2139/S170

W 52 - Vdc 24

Lm 2.600 (down) 1.200 (up)

M 2.700°K

C 3.000°K - W 4.000°K

L 1.700 x 20 mm

H 35 mm

L CAVI / CABLES 2.000 mm

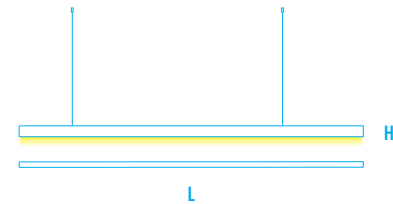

2139/S245

W 52 - Vdc 24

Lm 3.800

M 2.700°K

C 3.000°K - W 4.000°K

L 2.450 x 20 mm

H 35 mm

L CAVI / CABLES 2.000 mm

199

ESEMPI D'ORDINE / EXEMPLE OF ORDER

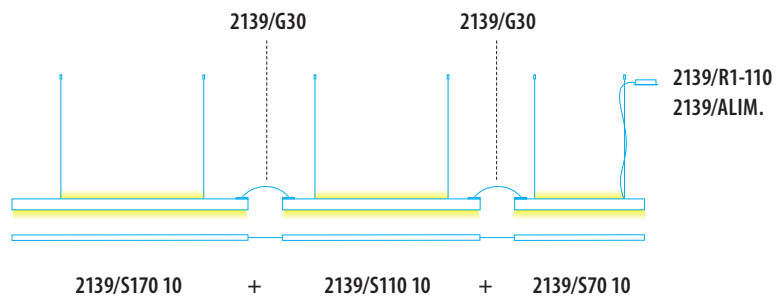

10
Bianco
White

15
Grigio
Grey

19
Nero
Black



200

2139/S70 + 2139/S110 + 2139/S170

BRAGA LED



LINK

accessori / accessories



2136/R1-60
Rosone con alimentatore 60W
Base with power supply 60W

BASE 320 x 100 mm
L 360 x 140 mm
H 45 mm

DIMMERABILE / DIMMABLE

2136/R1-60 - D4
Taglio di fase / Phase Cut

2136/R1-60 - D6
1-10V - DALI - PUSH

2136/R1-60 - D7
ZigBee

2136/R1-60 - D8
CASAMBI



2136/R1-110
Rosone con alimentatore 110W
Base with power supply 110W

BASE 320 x 100 mm
L 360 x 140 mm
H 45 mm

DIMMERABILE / DIMMABLE

2136/R1-110 - D4
Taglio di fase / Phase Cut

2136/R1-110 - D6
1-10V - DALI - PUSH

2136/R1-110 - D7
ZigBee

2136/R1-110 - D8
CASAMBI



2139/R140
Rosone senza alimentatore
Base with out power supply

Ø 140 mm
H 25 mm

201



AL.60-24
Alimentatore remoto
Remote power supply

DIMMERABILE / DIMMABLE

AL.60-24 - D4
Taglio di fase / Phase Cut

AL.60-24 - D6
1-10V - DALI - PUSH

AL.60-24 - D7
ZigBee

AL.60-24 - D8
CASAMBI



AL.110-24
Alimentatore remoto
Remote power supply

DIMMERABILE / DIMMABLE

AL.110-24 - D4
Taglio di fase / Phase Cut

AL.110-24 - D6
1-10V - DALI - PUSH

AL.110-24 - D7
ZigBee

AL.110-24 - D8
CASAMBI



2139/CAB
Alimentatore a spina 60W
con touch dimmer.
Wall mounted adaptor 60W
with 2 pole euro plug.



2139/ALIM.
Cavo alimentazione elettrica.
Power supply cable.
L 2.500 mm



2139/G30
Giunto elettrico
Electrical joint
L 300 mm



2139/G60
Giunto elettrico
Electrical joint
L 600 mm



2139/MC100
Modulo cieco cablato
Empty module wired
L 1.000 mm

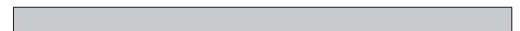

2139/MC200
Modulo cieco cablato
Empty module wired
L 2.000 mm

LINK

CRI > 80

DIMMERABILE / DIMMABLE

Vai a pagina / Go to page 457

DIFFUSORE / DIFFUSER

Silicone opalino

Opaline-finish Silicone

202



2139/P-S140

W 26 - Vdc 24

Lm 1.850

M 2.700°K

C 3.000°K - W 4.000°K

L 1.400 x 20 mm

H 35 mm



2139/P-S200

W 40 - Vdc 24

Lm 2.850

M 2.700°K

C 3.000°K - W 4.000°K

L 2.000 x 20 mm

H 35 mm

10
Bianco
White

15
Grigio
Grey

19
Nero
Black



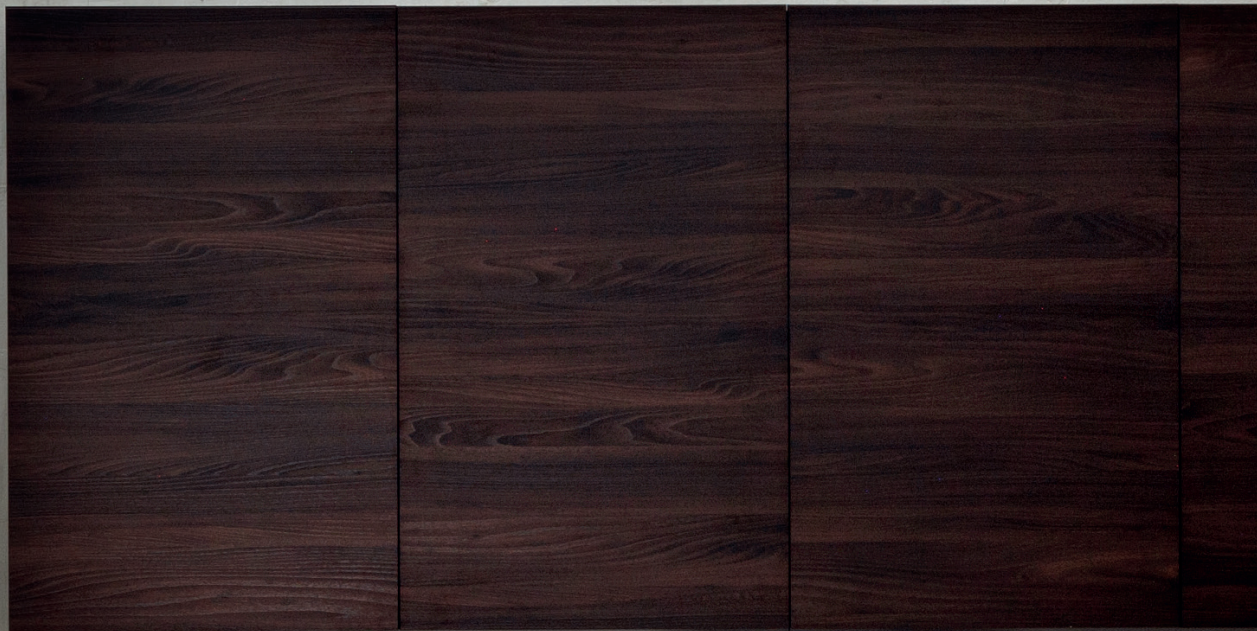

LINK

2139/CAB+2139/P-S200 + 2139/P-S140

LINK

CRI > 80

DIMMERABILE / DIMMABLE

Vai a pagina / Go to page 457

DIFFUSORE / DIFFUSER

Silicone opalino

Opaline-finish Silicone

204



2139/A70

W 19 - Vdc 24

Lm 1050 (down) 400 (up)

M 2.700°K

C 3.000°K - W 4.000°K

L 700 x 20 mm

H 35 mm



2139/A110

W 34 - Vdc 24

Lm 1.700 (down) 800 (up)

M 2.700°K

C 3.000°K - W 4.000°K

L 1.100 x 20 mm

H 35 mm



2139/A170

W 52 - Vdc 24

Lm 2.600 (DOWN) 1.200 (UP)

M 2.700°K

C 3.000°K - W 4.000°K

L 1.700 x 20 mm

H 35 mm



2139/A245

W 52 - Vdc 24

Lm 3.800

M 2.700°K

C 3.000°K - W 4.000°K

L 2.450 x 20 mm

H 35 mm

10
Bianco
White

15
Grigio
Grey

19
Nero
Black





205

LINK

2139/A70 + 2139/A110 + 2139/A170+ 2139/A245

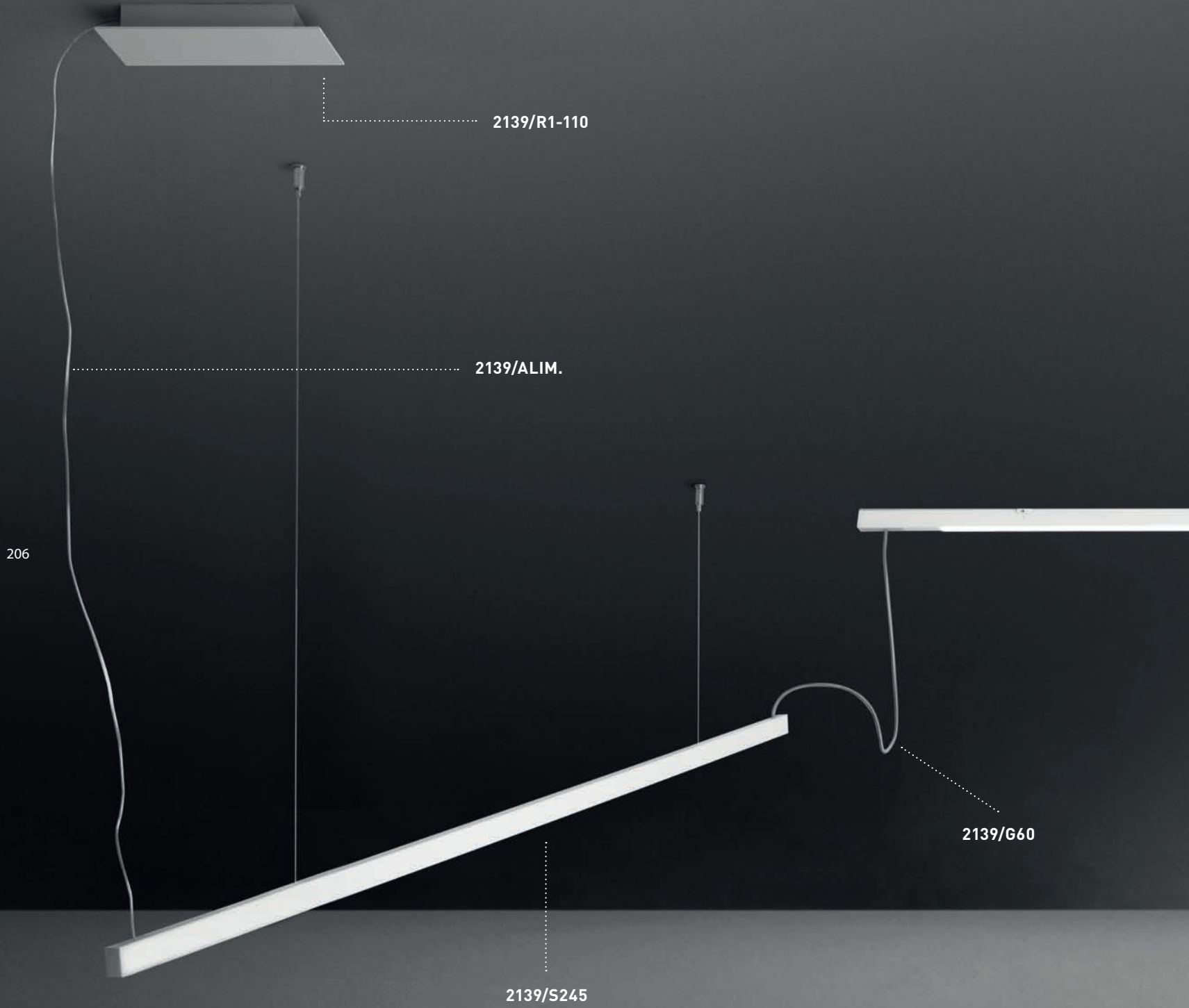

2139/R1-110

2139/ALIM.

206

2139/G60

2139/S245

2139/P-S200
L 2.000 mm

207

2139/G30

2139/MC100

2139/A70

LINK



LINK

CRI > 80

DIMMERABILE / DIMMABLE

Vai a pagina / Go to page 457

DIFFUSORE / DIFFUSER

Metacrilato opalino

Opaline-finish methacrylate

*** ROSONE / CANOPY**

Informazioni Tecniche vai a pag. 455

Technical info go to page 455



Rosone da incasso
Recessed canopy
Max 3,2 Kg

2146/R35

Ø 45 mm

H 35 mm



Ø 35 mm

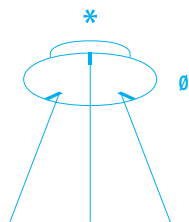

2141/R440-150

H 50 mm

Ø 500 x 440 mm

DIMMERABILE / DIMMABLE

2141/R440-150 - D4

Taglio di fase / Phase Cut

2141/R440-150 - D6

1-10V - DALI - PUSH

2141/R440-150 - D7

ZigBee

2141/R440-150 - D8

CASAMBI

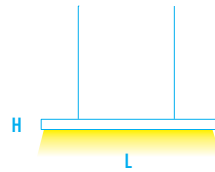

2141/70

W 14 - Vdc 24

Lm 1.050

M 2.700°K

C 3.000°K - W 4.000°K

L 700 x 20 mm

H 35 mm

L CAVI / CABLES 2.000 mm

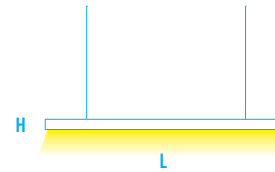

2141/110

W 23 - Vdc 24

Lm 1.700

M 2.700°K

C 3.000°K - W 4.000°K

L 1.100 x 20 mm

H 35 mm

L CAVI / CABLES 2.000 mm

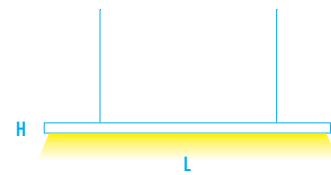

2141/170

W 36 - Vdc 24

Lm 2.600

M 2.700°K

C 3.000°K - W 4.000°K

L 1.700 x 20 mm

H 35 mm

L CAVI / CABLES 2.000 mm

ESEMPI DI COMPOSIZIONE / ESEMPI DI COMPOSIZIONE

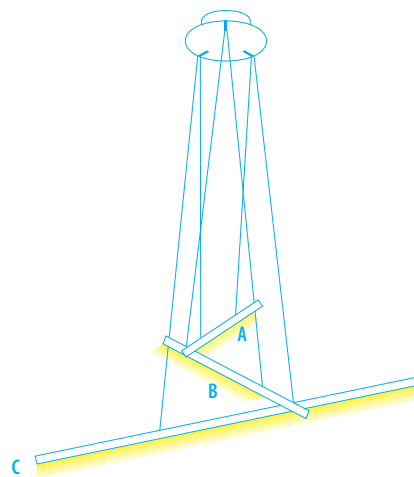

A
2141/70

B
2141/110

C
2141/170

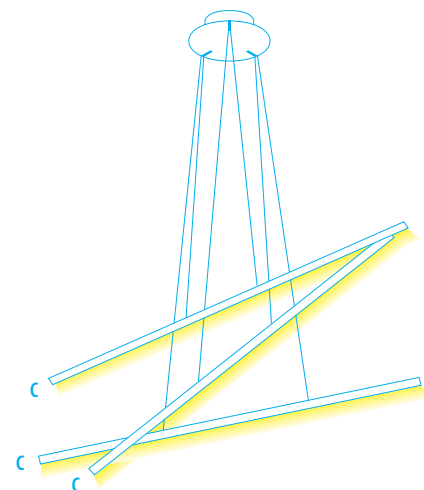

10
Bianco
White

15
Grigio
Grey

19
Nero
Black







211



212

2089/PL110

BRAGA LED

ELLE

CRI > 80

DIFFUSORE / DIFFUSER

Metacrilato opalino

Opaline-finish methacrylate

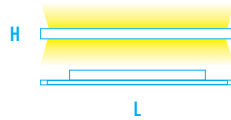
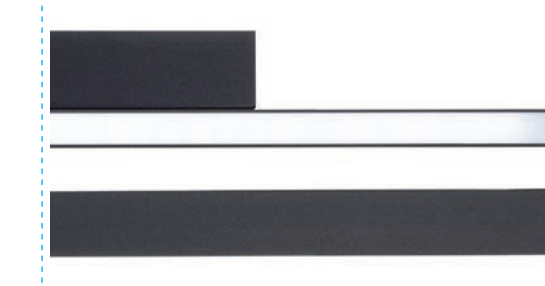

2089/A 70

W 25 - Vac 230

Lm 1.800

M 2.700°K - C 3.000°K - W 4.000°K

L 665 - SP 55 mm

H 30 mm

DIMMERABILE / DIMMABLE

2089/A70 - D4

Taglio di fase / Phase Cut

2089/A70 - D6

1-10V - DALI - PUSH

2089/A70-D8 CASAMBI

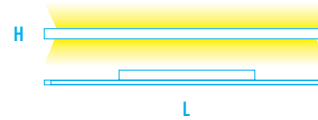

2089/A 110

W 42 - Vac 230

Lm 3.000

M 2.700°K - C 3.000°K - W 4.000°K

L 1085 - SP 55 mm

H 30 mm

DIMMERABILE / DIMMABLE

2089/A110 - D4

Taglio di fase / Phase Cut

2089/A110 - D6

1-10V - DALI - PUSH

2089/A110-D8 CASAMBI

213

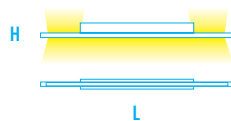
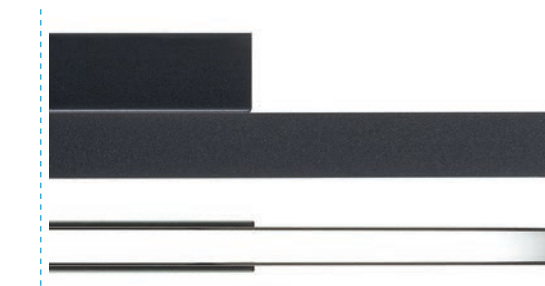

2089/PL 70

W 17 - Vac 230

Lm 1.200

M 2.700°K - C 3.000°K - W 4.000°K

L 665 - SP 70 mm

H 70 mm

DIMMERABILE / DIMMABLE

2089/PL70 - D4

Taglio di fase / Phase Cut

2089/PL70 - D6

1-10V - DALI - PUSH

2089/PL70-D8 CASAMBI

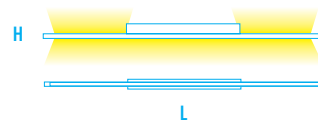

2089/PL110

W 34 - Vac 230

Lm 2.450

M 2.700°K - C 3.000°K - W 4.000°K

L 1085 - SP 70 mm

H 70 mm

DIMMERABILE / DIMMABLE

2089/PL110 - D4

Taglio di fase / Phase Cut

2089/PL110 - D6

1-10V - DALI - PUSH

2089/PL110-D8 CASAMBI

10

Bianco
White



13

Foglia Argento
Silver Leaf



14

Foglia Oro
Gold Leaf



15

Grigio
Grey



19

Nero
Black



21

Grigio tortora
Dove grey



22

Foglia rame
Copper leaf finish



23

Ruggine
Rust



24

Ferro
Iron



28

Oro
Gold



34

Rosè Verniciato
Painted Rosè



35

Bronzo Verniciato
Bronze Painted





214



216

2089/T

BRAGA LED





217



ELLE



2089/T

218

2089/S2

BRAGA LED

ELLE

CRI > 80

DIFFUSORE / DIFFUSER

Metacrilato opalino
Opaline-finish methacrylate

* ROSONE / CANOPY

Informazioni Tecniche vai a pag. 455
Technical info go to page 455

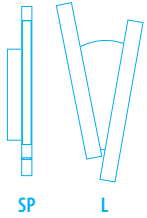

2089/A2

W 21 - Vac 230

Lm 1.500

M 2.700°K - C 3.000°K - W 4.000°K

L 190 x 380 mm

SP 45 mm

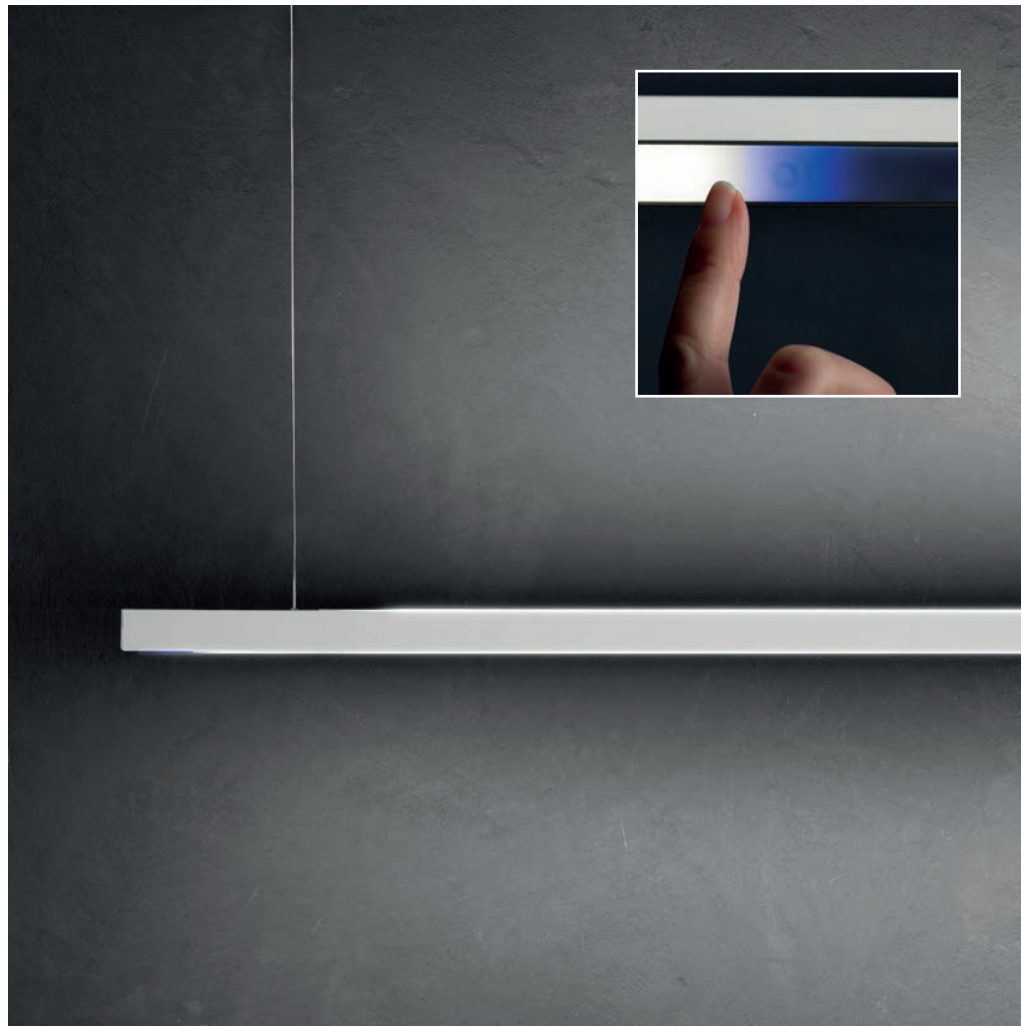

219

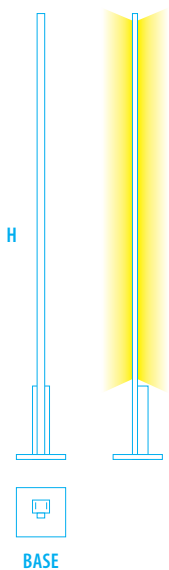

BASE

2089/T

W 60 - Vac 230

Lm 4.300

M 2.700°K - C 3.000°K - W 4.000°K

H 1.950

BASE 250 x 250 mm

TOUCH DIMMER

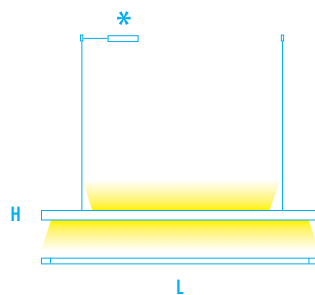

2089/S

W 47 - Vac 230

Lm 1.950 (Down) 1.450 (Up)

M 2.700°K - C 3.000°K - W 4.000°K

L 1.330 x 20 - H 30 mm

L CAVI / CABLES 1.800 mm

TOUCH DIMMER

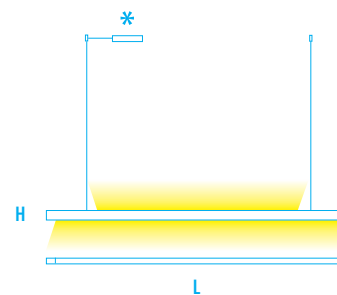

2089/S2

W 56 - Vac 230

Lm 2.350 (Down) 1.700 (Up)

M 2.700°K - C 3.000°K - W 4.000°K

L 1.630 x 20 - H 30 mm

L CAVI / CABLES 1.800 mm

TOUCH DIMMER

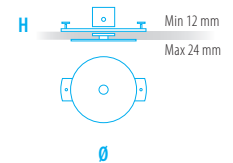

Rosone da incasso
Recessed canopy
Max 3,2 Kg

2146/R35

Ø 45 mm

H 35 mm

Ø 35 mm



Solo / Only

2089/S - 2089/S2

Alimentatore Remoto

Remote Power Supply



Scia

220



2127/S3

BRAGA LED



221

SCIA

2127/PL



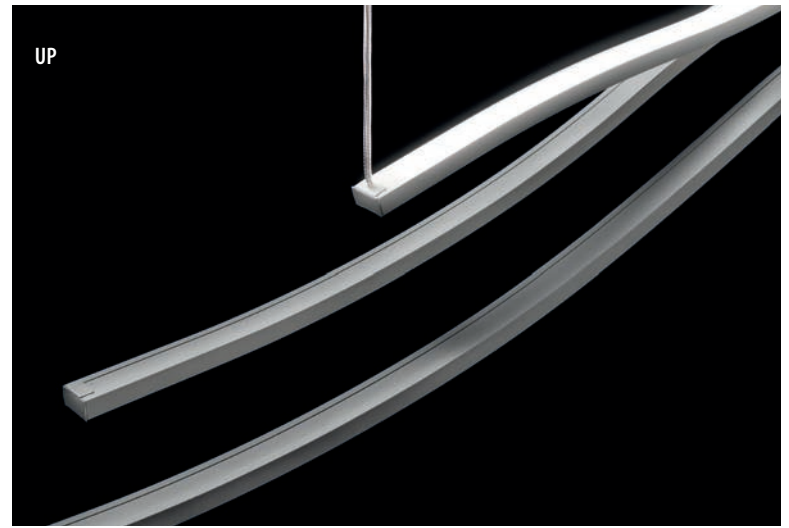

CRI > 80

DIMMERABILE / DIMMABLE

Vai a pagina / Go to page 457

DIFFUSORE / DIFFUSER

Metacrilato opalino

Opaline-finish methacrylate

*** ROSONE / CANOPY**

Informazioni Tecniche vai a pag. 455

Technical info go to page 455

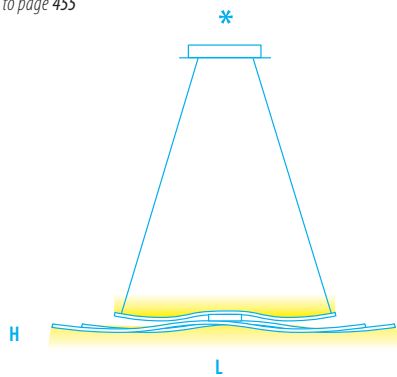

2127/S

W 49 - Vac 230

Lm 3.000 (down) 1.000 (up)

M 2.700°K - C 3.000°K - W 4.000°K

L 1200 mm

H 10 mm

L CAVI / CABLES 1700mm

DIMMERABILE / DIMMABLE

2127/S - D4

Taglio di fase / Phase Cut

2127/S - D6

1-10V - DALI - PUSH

2127/S - D7

ZigBee

2127/S - D8

CASAMBI

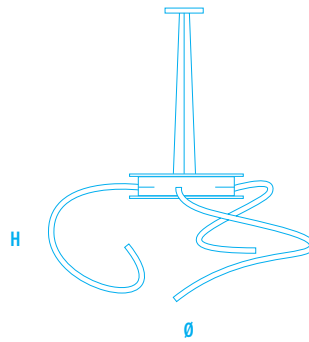

2127/S3

W 53 - Vac 230

Lm 4.000

M 2.700°K - C 3.000°K - W 4.000°K

Ø 700 mm

H 250 mm

L CAVI / CABLES 2000 mm

DIMMERABILE / DIMMABLE

2127/S - D4

Taglio di fase / Phase Cut

2127/S3 - D6

1-10V - DALI - PUSH

2127/S3 - D7

ZigBee

2127/S3 - D8

CASAMBI

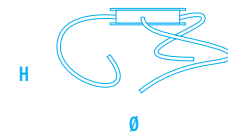

2127/PL

W 53 - Vac 230

Lm 4.000

M 2.700°K - C 3.000°K - W 4.000°K

Ø 700 mm

H 250 mm

DIMMERABILE / DIMMABLE

2127/PL - D4

Taglio di fase / Phase Cut

2127/PL - D6

1-10V - DALI - PUSH

2127/PL - D7

ZigBee

2127/PL - D8

CASAMBI

10

Bianco
White



14

Foglia Oro
Gold Leaf



15

Grigio
Grey



19

Nero
Black



28

Oro
Gold



224



2127/PL50

BRAGA LED













230



2127/L

BRAGA LED



232



SCIA

CRI > 80

DIMMERABILE / DIMMABLE

Vai a pagina / Go to page 457

DIFFUSORE / DIFFUSER

Metacrilato opalino

Opaline-finish methacrylate



H

BASE

2127/L

W 4 - **Vac** 230

Lm 350

M 2.700°K - **C** 3.000°K - **W** 4.000°K

H 350 mm

BASE 100 x 100 mm

TOUCH DIMMER

233

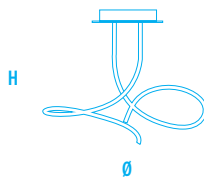

H

Ø

2127/PL50

W 42 - **Vac** 230

Lm 3.300

M 2.700°K - **C** 3.000°K - **W** 4.000°K

Ø 550 mm

H 600 mm

DIMMERABILE / DIMMABLE

2127/PL50 - D4

Taglio di fase / Phase Cut

2127/PL50 - D6

1-10V - DALI - PUSH

2127/PL50 - D7

ZigBee

2127/PL50 - D8

CASAMBI



H

Ø

2127/PL60

W 49 - **Vac** 230

Lm 3.700

M 2.700°K - **C** 3.000°K - **W** 4.000°K

Ø 520 mm

H 600 mm

DIMMERABILE / DIMMABLE

2127/PL60 - D4

Taglio di fase / Phase Cut

2127/PL60 - D6

1-10V - DALI - PUSH

2127/PL60 - D7

ZigBee

2127/PL60 - D8

CASAMBI

10
Bianco
White



14
Foglia Oro
Gold Leaf



15
Grigio
Grey



19
Nero
Black



28
Oro
Gold



234



2127/A2

BRAGA LED



SCIA

CRI > 80

DIMMERABILE / DIMMABLE

Vai a pagina / Go to page 457

DIFFUSORE / DIFFUSER

Metacrilato opalino

Opaline-finish methacrylate

235

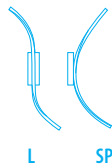

2127/A1

W 10 - Vac 230

Lm 800

M 2.700°K - C 3.000°K - W 4.000°K

L 510 mm x 55 mm

SP 160 mm

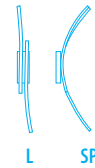

2127/A2

W 14 - Vac 230

Lm 1.100

M 2.700°K - C 3.000°K - W 4.000°K

L 540 mm x 55 mm

SP 150 mm

10
Bianco
White



14
Foglia Oro
Gold Leaf



15
Grigio
Grey



19
Nero
Black



28
Oro
Gold



SCIA

CRI > 80

DIMMERABILE / DIMMABLE

Vai a pagina / Go to page 457

DIFFUSORE / DIFFUSER

Metacrilato opalino

Opaline-finish methacrylate

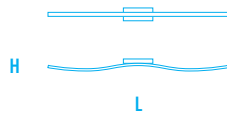

2127/PL1

W 17 - Vac 230

Lm 1.350

M 2.700°K - C 3.000°K - W 4.000°K

L 1.000 mm x 100 mm

H 50 mm

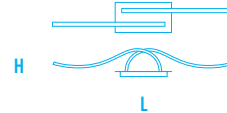

2127/PL2

W 23 - Vac 230

Lm 1.800

M 2.700°K - C 3.000°K - W 4.000°K

L 1.000 mm x 145 mm

H 70 mm

DIMMERABILE / DIMMABLE

2127/PL2 - D4

Taglio di fase / Phase Cut

2127/PL2 - D6

1-10V - DALI - PUSH - Bluetooth

2127/PL2 - D7

ZigBee

2127/PL2 - D8

CASAMBI

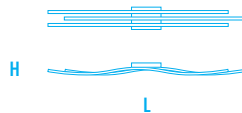

2127/PL3

W 51 - Vac 230

Lm 4.100

M 2.700°K - C 3.000°K - W 4.000°K

L 1.130 mm x 145 mm

H 70 mm

DIMMERABILE / DIMMABLE

2127/PL3 - D4

Taglio di fase / Phase Cut

2127/PL3 - D6

1-10V - DALI - PUSH

2127/PL3 - D7

ZigBee

2127/PL3 - D8

CASAMBI

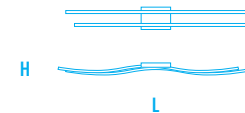

2127/PL110-2

W 34 - Vac 230

Lm 2.750

M 2.700°K - C 3.000°K - W 4.000°K

L 1.130 mm x 145 mm

H 70 mm

DIMMERABILE / DIMMABLE

2127/PL110-2 - D4

Taglio di fase / Phase Cut

2127/PL110-2 - D6

1-10V - DALI - PUSH

2127/PL110-2 - D7

ZigBee

2127/PL110-2 - D8

CASAMBI

10
Bianco
White



14
Foglia Oro
Gold Leaf



15
Grigio
Grey



19
Nero
Black



28
Oro
Gold





Tape

238



2133/PLS-7

BRAGA LED

TAPE

CRI > 80

DIMMERABILE / DIMMABLE

Vai a pagina / Go to page 457

DIFFUSORE / DIFFUSER

Metacrilato opalino

Opaline-finish methacrylate

239

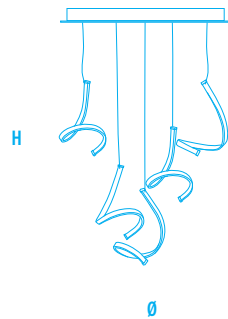

2133/PLS-5

W 45 - Vac 230

Lm 3.750

M 2.700°K - C 3.000°K - W 4.000°K

Ø 440 mm

H 45 mm

L CAVI/CABLES 1.700 mm

DIMMERABILE / DIMMABLE

2133/PLS-5 - D4

Taglio di fase / Phase Cut

2133/PLS-5 - D6

1-10V - DALI - PUSH

2133/PLS-5 - D7

ZigBee

2133/PLS-5 - D8

CASAMBI

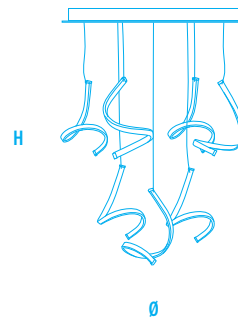

2133/PLS-7

W 63 - Vac 230

Lm 5.250

M 2.700°K - C 3.000°K - W 4.000°K

Ø 560 mm

H 45 mm

L CAVI/CABLES 1.700 mm

DIMMERABILE / DIMMABLE

2133/PLS-7 - D4

Taglio di fase / Phase Cut

2133/PLS-7 - D6

1-10V - DALI - PUSH

2133/PLS-7 - D7

ZigBee

2133/PLS-7 - D8

CASAMBI

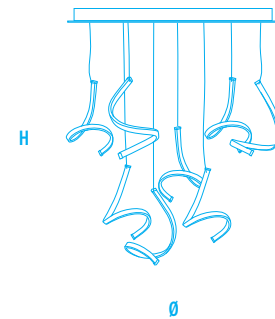

2133/PLS-11

W 99 - Vac 230

Lm 8.250

M 2.700°K - C 3.000°K - W 4.000°K

Ø 700 mm

H 45 mm

L CAVI/CABLES 1.700 mm

DIMMERABILE / DIMMABLE

2133/PLS-11 - D4

Taglio di fase / Phase Cut

2133/PLS-11 - D6

1-10V - DALI - PUSH

2133/PLS-11 - D7

ZigBee

2133/PLS-11 - D8

CASAMBI

10
Bianco
White

15
Grigio
Grey

19
Nero
Black



240







TAPE

CRI > 80

DIMMERABILE / DIMMABLE

Vai a pagina / Go to page 457

DIFFUSORE / DIFFUSER

Metacrilato opalino

Opaline-finish methacrylate

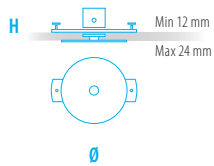

Rosone da incasso
Recessed canopy
Max 3,2 Kg

2146/R35

Ø 45 mm

H 35 mm



Ø 35 mm

Alimentatore Remoto
Remote Power Supply

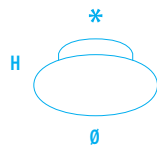

2133/R

Ø 220 mm

H 30 mm

Rosone per collegamento
da 2 a 7 2133/SM

Rose for connection from
2 to 7 2133/SM

DIMMERABILE / DIMMABLE

2133/R - D4

Taglio di fase / Phase Cut

2133/R - D6

1-10V - DALI - PUSH

2133/R - D8

CASAMBI



2133/N

Ø 20 mm

H 15 mm

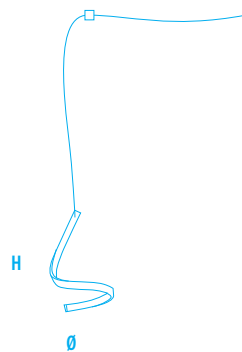

2133/SM

W 9 - Vdc 24

Lm 750

M 2.700°K - C 3.000°K - W 4.000°K

Ø 150 mm

H 240 mm

L CAVO / CABLES 2.000 mm

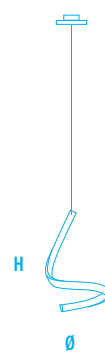

2133/S1

W 9 - Vac 230

Lm 750

M 2.700°K - C 3.000°K - W 4.000°K

Ø 150 mm

H 160 mm

L CAVO / CABLES 1.700 mm

10
Bianco
White

15
Grigio
Grey

19
Nero
Black



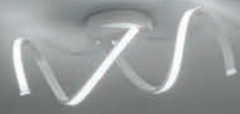





246



2133/A1

BRAGA LED



TAPE

2133/A2

248



2133/L

BRAGA LED

TAPE

CRI > 80

DIMMERABILE / DIMMABLE

Vai a pagina / Go to page 457

DIFFUSORE / DIFFUSER

Metacrilato opalino

Opaline-finish methacrylate

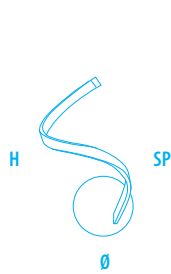

2133/A1

W 9 - Vac 230
Lm 750
M 2.700°K - C 3.000°K - W 4.000°K
Ø 150 mm
H 270 mm
SP 130 mm

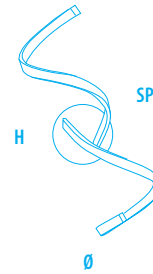

2133/A2

W 18 - Vac 230
Lm 1.500
M 2.700°K - C 3.000°K - W 4.000°K
Ø 150 mm
H 370 mm
SP 130 mm

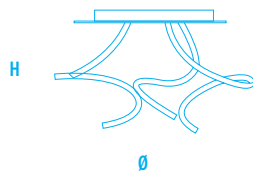

2133/PL3

W 27 - Vac 230
Lm 2.250
M 2.700°K - C 3.000°K - W 4.000°K
Ø 400 mm
H 250 mm

DIMMERABILE / DIMMABLE

2133/PL3 - D4

Taglio di fase / Phase Cut

2133/PL3 - D6

1-10V - DALI - PUSH

2133/PL3 - D7

ZigBee

2133/PL3 - D8

CASAMBI



2133/L

W 5 - Vac 230
Lm 450
M 2.700°K - C 3.000°K - W 4.000°K
H 350 mm
BASE 100 x 100 mm

10
Bianco
White

15
Grigio
Grey

19
Nero
Black



Ray



250

2125/PL70

BRAGA LED

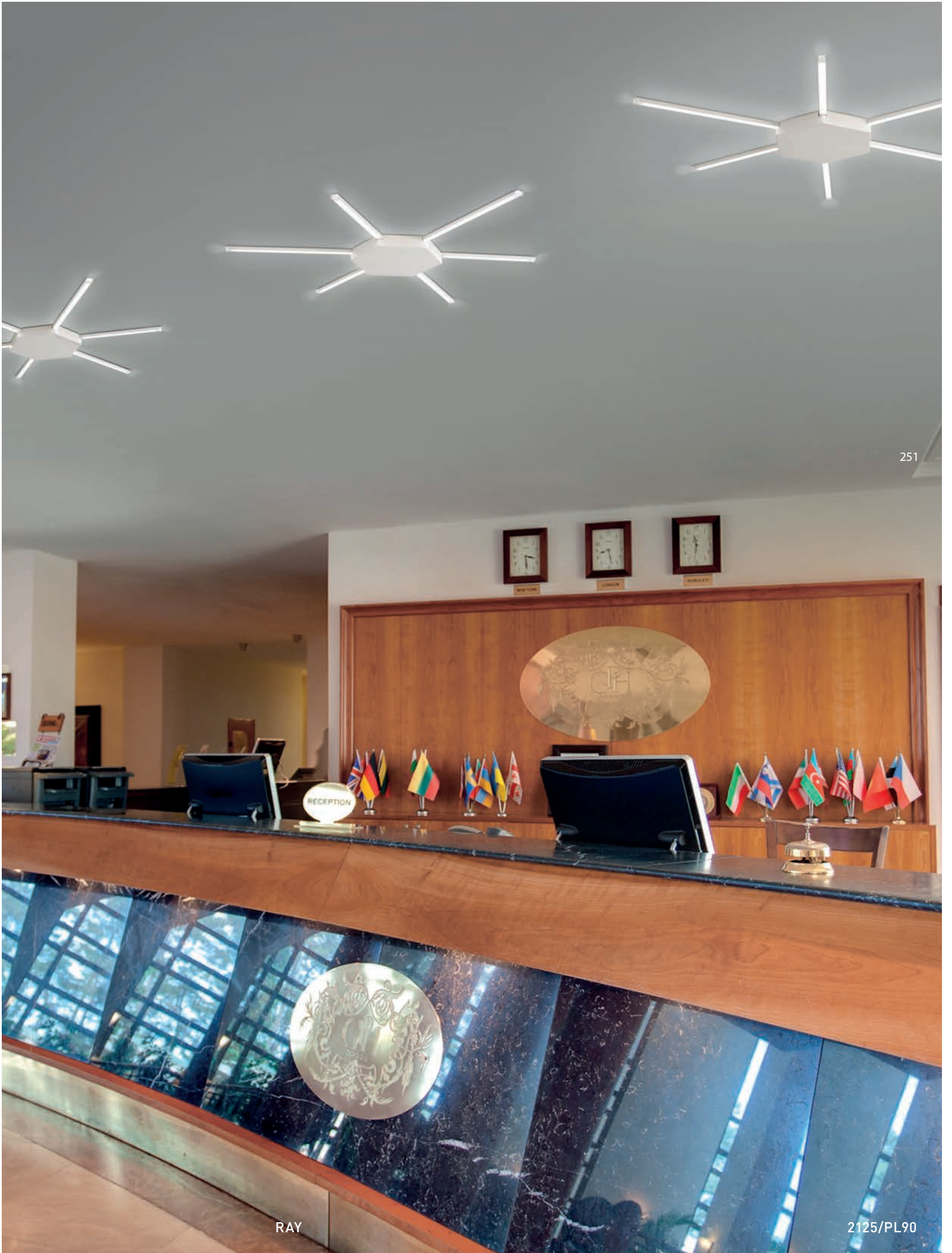

CHANGE
IS
GOOD



KEEP
IT
SIMPLE

This Week:
^ ^ ^ ^ ^ ^ ^ ^



252





RAY



253

2125/A2

RAY

CRI > 80

DIMMERABILE / DIMMABLE

Vai a pagina / Go to page 457

DIFFUSORE / DIFFUSER

Metacrilato opalino

Opaline-finish methacrylate

254

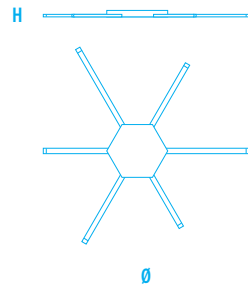

2125/PL 90

W 29 - **Vac** 230
Lm 2.200
M 2.700°K - **C** 3.000°K - **W** 4.000°K
Ø 900 mm
H 40 mm

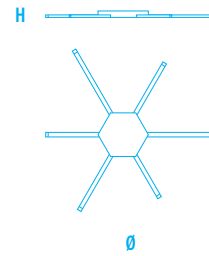

2125/PL 70

W 22 - **Vac** 230
Lm 1.700
M 2.700°K - **C** 3.000°K - **W** 4.000°K
Ø 700 mm
H 40 mm

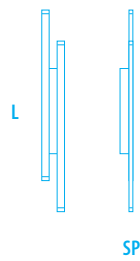

2125/A2

W 15 - **Vac** 230
Lm 1.100
M 2.700°K - **C** 3.000°K - **W** 4.000°K
L 560 x 60 mm
SP 35 mm

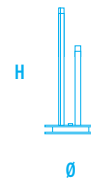

2125/L

W 8 - **Vac** 230
Lm 600
M 2.700°K - **C** 3.000°K - **W** 4.000°K
Ø 140 mm
H 320 mm
TOUCH DIMMER

10
Bianco
White





255

RAY

2125/L

Traccia

256



2053/T1A

2053/T2B19

BRAGA LED

TRACCIA

CRI > 80

DIMMERABILE / DIMMABLE

Vai a pagina / Go to page 457

DIFFUSORE / DIFFUSER

Metacrilato opalino

Opaline-finish methacrylate



2053/AP-R

W 28 - Vac 230

Lm 1.950

M 2.700°K - C 3.000°K - W 4.000°K

H 1.700 x L 23 mm

SP 55 mm

BASE

H 230 x L 50 mm

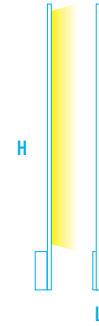

2053/AP-F

W 27 - Vac 230

Lm 1.900

M 2.700°K - C 3.000°K - W 4.000°K

H 1.700 x L 23 mm

SP 55 mm

BASE

H 230 x L 50 mm

TOUCH DIMMER

10

Bianco
White



19

Nero
Black



2053/T1A

W 29 - Vac 230

Lm 2.300

M 2.700°K - C 3.000°K - W 4.000°K

H 2.100 mm

L Braccio 500 mm

BASE

L 280 x 170 x H 15 mm

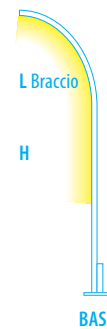

2053/T2B19

W 23 - Vac 230

Lm 1.800

M 2.700°K - C 3.000°K - W 4.000°K

H 1.960 mm

L Braccio 500 mm

BASE

L 280 x 170 x H 15 mm

TOUCH DIMMER

10

Bianco
White





258

2053/AP-F

BRAGA LED





260

2047/A

BRAGA LED

TRACCIA

CRI > 80

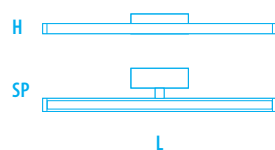

2047/A1

W 8 - Vac 230

Lm 600

M 2.700°K - C 3.000°K - W 4.000°K

L 430 x H 45 mm

SP 112 mm

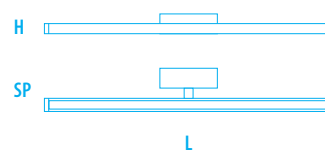

2047/A

W 13 - Vac 230

Lm 1.000

M 2.700°K - C 3.000°K - W 4.000°K

L 715 x H 45 mm

SP 112 mm

10

Bianco
White



11

Cromo
Chrome



14

Foglia Oro
Gold Leaf Finish



Digit

262

2068/S

BRAGA LED





263



DIGIT

2068/A3



264

2068/PL125

BRAGA LED

DIGIT

CRI > 80

DIFFUSORE / DIFFUSER

Metacrilato opalino

Opaline-finish methacrylate

* ROSONE / CANOPY

Informazioni Tecniche vai a pag. 455

Technical info go to page 455

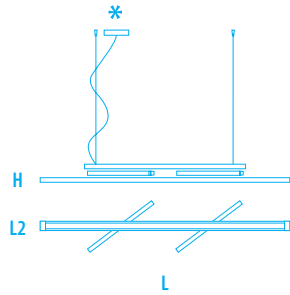

2068/S

W 56 - Vac 230

Lm 4.000

M 2.700°K - C 3.000°K - W 4.000°K

L 1.250 x L2 250 x H 60 mm

L CAVI / CABLES 2.000 mm

DIMMERABILE / DIMMABLE

2068/S-D6

1-10V - DALI - PUSH

2068/S-D8 CASAMBI



2068/PL125 + 2068/PL80

265

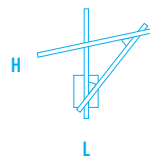

2068/A3

W 22 - Vac 230

Lm 1.500

M 2.700°K - C 3.000°K - W 4.000°K

L 380 x H 380 mm

SP 110 mm

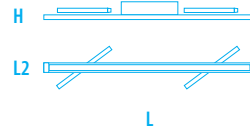

2068/PL80

W 28 - Vac 230

Lm 2.000

M 2.700°K - C 3.000°K - W 4.000°K

L 840 x L2 250 x H 70 mm

DIMMERABILE / DIMMABLE

2068/PL80-D6

1-10V - DALI - PUSH

2068/PL80-D8 CASAMBI

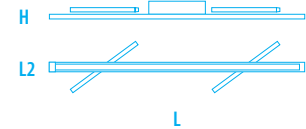

2068/PL125

W 40 - Vac 230

Lm 2.900

M 2.700°K - C 3.000°K - W 4.000°K

L 1.250 x L2 250 x H 70 mm

DIMMERABILE / DIMMABLE

2068/PL125-D6

1-10V - DALI - PUSH

2068/PL125-D8 CASAMBI

10

Bianco
White



Pattern

266

2095/PL50

BRAGA LED







268

PATTERN

CRI > 80

DIMMERABILE / DIMMABLE

Vai a pagina / Go to page 457

DIFFUSORE / DIFFUSER

Metacrilato opalino

Opaline-finish methacrylate



269



2095/PL36

W 19 - Vac 230

Lm 1.450

M 2.700°K - C 3.000°K - W 4.000°K

L 360 x 360 mm

SP 35 mm

DIMMERABILE / DIMMABLE

2095/PL36-D1 PUSH

2095/PL36-D2 1-10V

2095/PL36-D3 DALI

2095/PL36-D4 Taglio di fase / Phase cut

2095/PL36-D7 ZigBee

2095/PL36-D8 CASAMBI

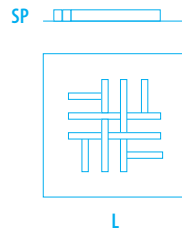

2095/PL50

W 35 - Vac 230

Lm 2.600

M 2.700°K - C 3.000°K - W 4.000°K

L 500 x 500 mm

SP 45 mm

DIMMERABILE / DIMMABLE

2095/PL50-D1 PUSH

2095/PL50-D2 1-10V

2095/PL50-D3 DALI

2095/PL50-D4 Taglio di fase / Phase cut

2095/PL50-D7 ZigBee

2095/PL50-D8 CASAMBI

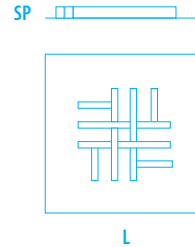

2095/PL60

W 35 - Vac 230

Lm 2.600

M 2.700°K - C 3.000°K - W 4.000°K

L 600 x 600 mm

SP 45 mm

DIMMERABILE / DIMMABLE

2095/PL60-D1 PUSH

2095/PL60-D2 1-10V

2095/PL60-D3 DALI

2095/PL60-D4 Taglio di fase / Phase cut

2095/PL60-D7 ZigBee

2095/PL60-D8 CASAMBI

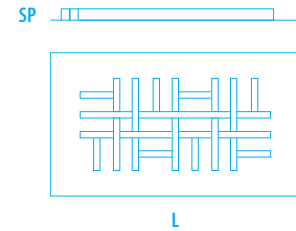

2095/PL80

W 70 - Vac 230

Lm 5.200

M 2.700°K - C 3.000°K - W 4.000°K

L 500 x 800 mm

SP 45 mm

DIMMERABILE / DIMMABLE

2095/PL80-D1 PUSH

2095/PL80-D2 1-10V

2095/PL80-D3 DALI

2095/PL80-D4 Taglio di fase / Phase cut

2095/PL80-D7 ZigBee

2095/PL80-D8 CASAMBI

10

Bianco
White



11

Cromo
Chrome



13

Foglia Argento
Silver Leaf



14

Foglia Oro
Gold Leaf



19

Nero
Black



20

Corten
Corten



21

Grigio tortora
Dove grey



26

Inox
Inox



27

Ossidato
Oxydized



30

Gunmetal



31

Rosé Spaz.
Brushed Rosé



32

Bronzo Spaz.
Brush. Bronze



33

Oro Spaz.
Brush. Gold







PATTERN

CRI > 80

DIMMERABILE / DIMMABLE

Vai a pagina / Go to page 457

DIFFUSORE / DIFFUSER

Metacrilato opalino

Opaline-finish methacrylate

272

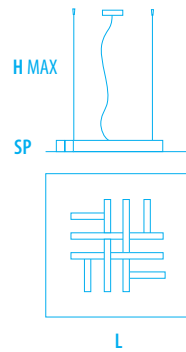

2095/S50

SOTTO / DOWN

W 35 - Vac 230

Lm 2.600

SOPRA / UP

W 7 - Vac 230

Lm 500

M 2.700°K - C 3.000°K - W 4.000°K

L 500 x 500 mm

SP 35 mm

H MAX 1.300 mm

DIMMERABILE / DIMMABLE

- 2095/S50-D1 PUSH
- 2095/S50-D2 1-10V
- 2095/S50-D3 DALI
- 2095/S50-D4 Taglio di fase / Phase cut
- 2095/S50-D7 ZigBee
- 2095/S50-D8 CASAMBI

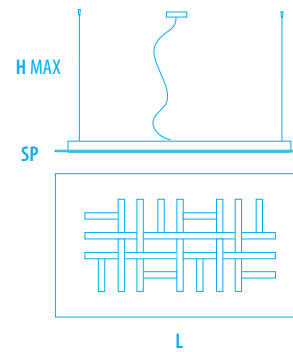

2095/S80

SOTTO / DOWN

W 70 - Vac 230

Lm 5.200

SOPRA / UP

W 14 - Vac 230

Lm 1.000

M 2.700°K - C 3.000°K - W 4.000°K

L 500 x 800 mm

SP 35 mm

H MAX 1.300 mm

DIMMERABILE / DIMMABLE

- 2095/S80-D1 PUSH
- 2095/S80-D2 1-10V
- 2095/S80-D3 DALI
- 2095/S80-D4 Taglio di fase / Phase cut
- 2095/S80-D7 ZigBee
- 2095/S80-D8 CASAMBI

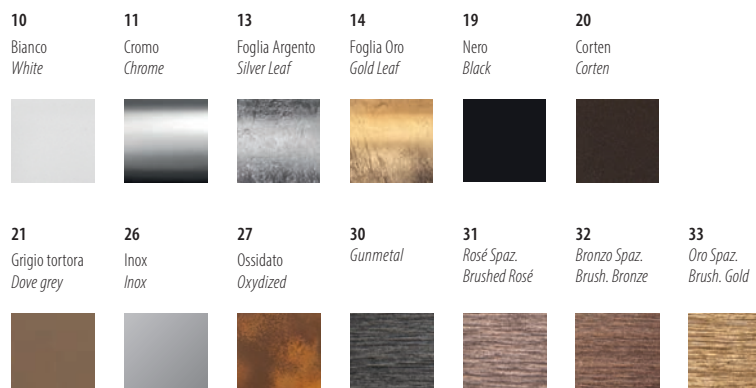



Cristalli

274

2052/PL50

BRAGA LED





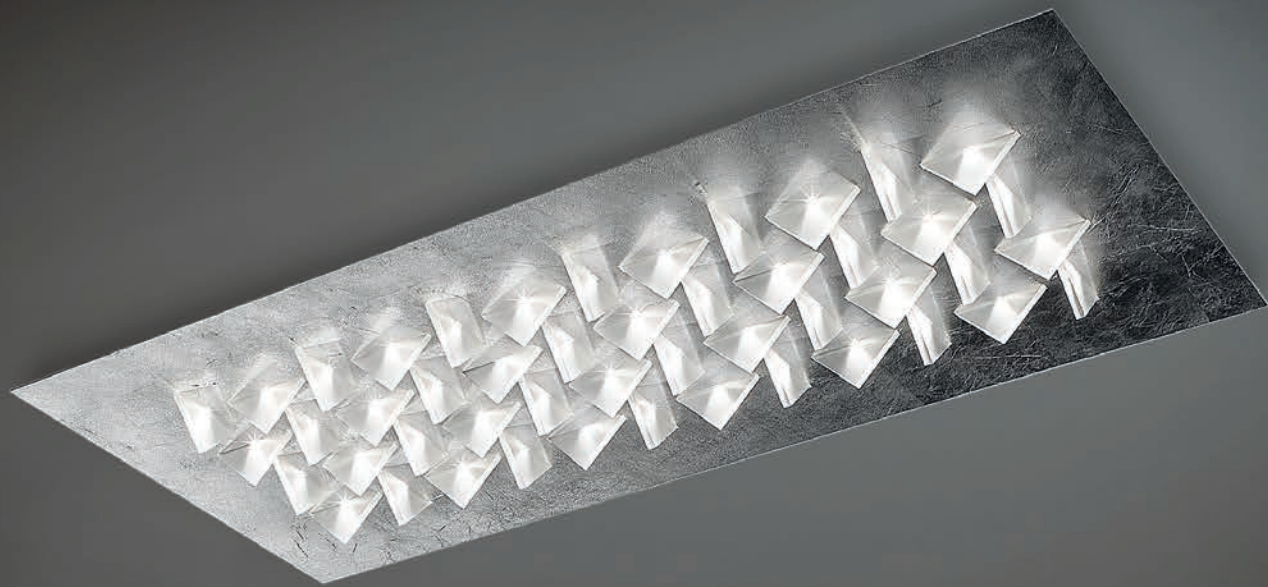

276



2052/PL110

BRAGA LED

CRISTALLI

CRI > 90

DIMMERABILE / DIMMABLE

Vai a pagina / Go to page 457

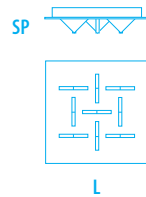

2052/PL 36

W 19 - **Vac** 230
Lm 1.450
M 2.700°K - **C** 3.000°K - **W** 4.000°K
L 360 x 360 mm
SP 80 mm

DIMMERABILE / DIMMABLE

- 2052/PL36-D1 PUSH
- 2052/PL36-D2 1-10V
- 2052/PL36-D3 DALI
- 2052/PL36-D4 Taglio di fase / Phase cut
- 2052/PL36-D7 ZigBee
- 2052/PL36-D8 CASAMBI

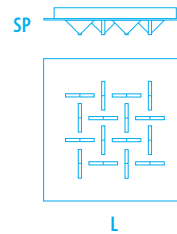

2052/PL 50

W 35 - **Vac** 230
Lm 2.600
M 2.700°K - **C** 3.000°K - **W** 4.000°K
L 500 x 500 mm
SP 80 mm

DIMMERABILE / DIMMABLE

- 2052/PL50-D1 PUSH
- 2052/PL50-D2 1-10V
- 2052/PL50-D3 DALI
- 2052/PL50-D4 Taglio di fase / Phase cut
- 2052/PL50-D7 ZigBee
- 2052/PL50-D8 CASAMBI

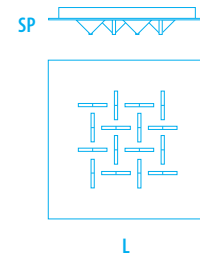

2052/PL 60

W 35 - **Vac** 230
Lm 2.600
M 2.700°K - **C** 3.000°K - **W** 4.000°K
L 600 x 600 mm
SP 80 mm

DIMMERABILE / DIMMABLE

- 2052/PL60-D1 PUSH
- 2052/PL60-D2 1-10V
- 2052/PL60-D3 DALI
- 2052/PL60-D4 Taglio di fase / Phase cut
- 2052/PL60-D7 ZigBee
- 2052/PL60-D8 CASAMBI

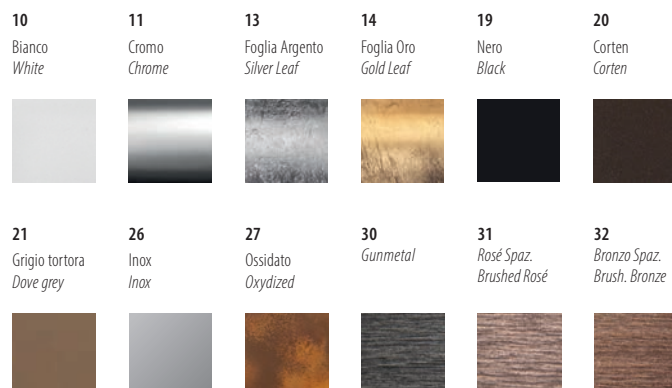



278

2051/PL80

BRAGA LED



279

CRISTALLI

2051/PL60

280

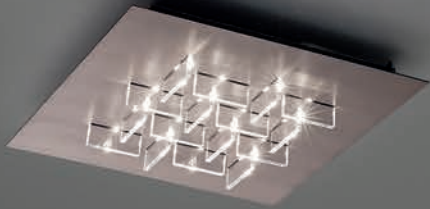
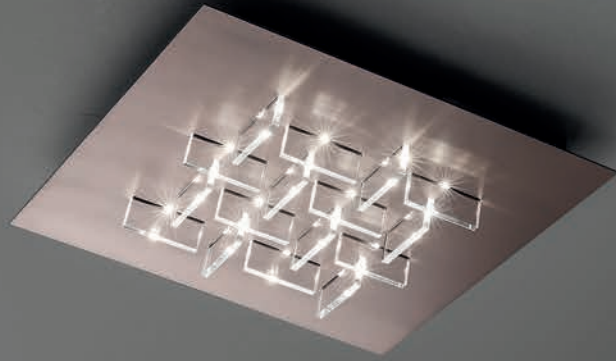

2051/PL50



BRAGA LED

CRISTALLI

CRI > 90

DIMMERABILE / DIMMABLE

Vai a pagina / Go to page 457

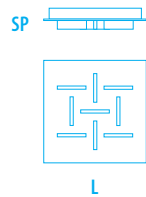

2051/PL 36

W 19 - Vac 230

Lm 1.450
M 2.700°K - C 3.000°K
W 4.000°K

L 360 x 360 mm
SP 70 mm

DIMMERABILE / DIMMABLE

- 2051/PL36-D1 PUSH
- 2051/PL36-D2 1-10V
- 2051/PL36-D3 DALI
- 2051/PL36-D4 Taglio di fase / Phase cut
- 2051/PL36-D7 ZigBee
- 2051/PL36-D8 CASAMBI

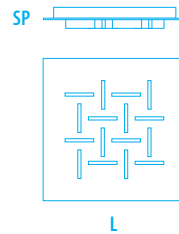

2051/PL 50

W 35 - Vac 230

Lm 2.600
M 2.700°K - C 3.000°K
W 4.000°K

L 500 x 500 mm
SP 70 mm

DIMMERABILE / DIMMABLE

- 2051/PL50-D1 PUSH
- 2051/PL50-D2 1-10V
- 2051/PL50-D3 DALI
- 2051/PL50-D4 Taglio di fase / Phase cut
- 2051/PL50-D7 ZigBee
- 2051/PL50-D8 CASAMBI

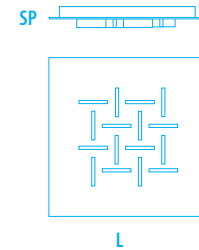

2051/PL 60

W 35 - Vac 230

Lm 2.600
M 2.700°K - C 3.000°K
W 4.000°K

L 600 x 600 mm
SP 70 mm

DIMMERABILE / DIMMABLE

- 2051/PL60-D1 PUSH
- 2051/PL60-D2 1-10V
- 2051/PL60-D3 DALI
- 2051/PL60-D4 Taglio di fase / Phase cut
- 2051/PL60-D7 ZigBee
- 2051/PL60-D8 CASAMBI

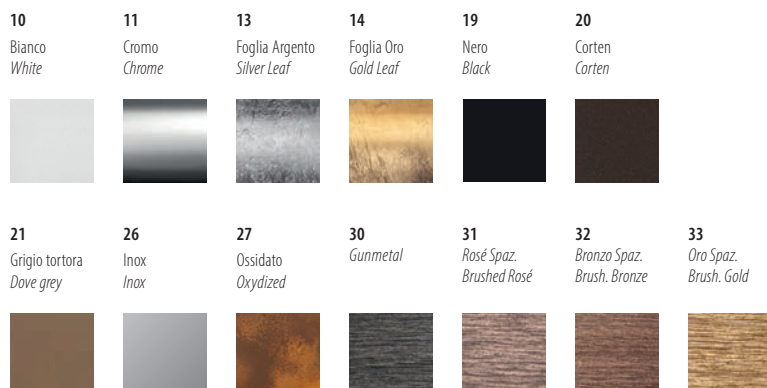



282

2051/PL50

BRAGA LED

CRISTALLI

CRI > 90

DIMMERABILE / DIMMABLE

Vai a pagina / Go to page 457

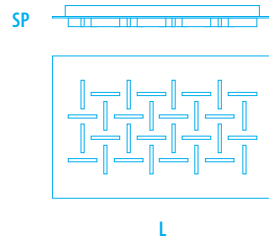

2051/PL80

W 70 - Vac 230

Lm 5.200

M 2.700°K - C 3.000°K

W 4.000°K

L 500 x 800 mm

SP 70 mm

DIMMERABILE / DIMMABLE

- 2051/PL80-D1 PUSH
- 2051/PL80-D2 1-10V
- 2051/PL80-D3 DALI
- 2051/PL80-D4 Taglio di fase / Phase cut
- 2051/PL80-D7 ZigBee
- 2051/PL80-D8 CASAMBI

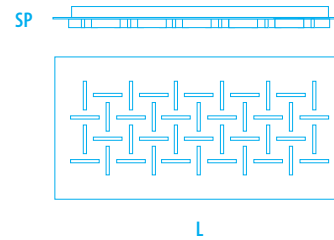

2051/PL110

W 105 - Vac 230

Lm 7.800

M 2.700°K - C 3.000°K

W 4.000°K

L 500 x 1100 mm

SP 70 mm

DIMMERABILE / DIMMABLE

- 2051/PL110-D1 PUSH
- 2051/PL110-D2 1-10V
- 2051/PL110-D3 DALI
- 2051/PL110-D4 Taglio di fase / Phase cut
- 2051/PL110-D7 ZigBee
- 2051/PL110-D8 CASAMBI

283

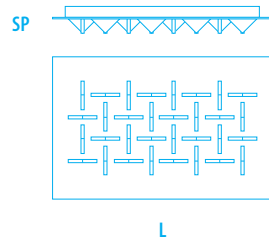

2052/PL80

W 70 - Vac 230

Lm 5.200

M 2.700°K - C 3.000°K

W 4.000°K

L 500 x 800 mm

SP 80 mm

DIMMERABILE / DIMMABLE

- 2052/PL80-D1 PUSH
- 2052/PL80-D2 1-10V
- 2052/PL80-D3 DALI
- 2052/PL80-D4 Taglio di fase / Phase cut
- 2052/PL80-D7 ZigBee
- 2052/PL80-D8 CASAMBI

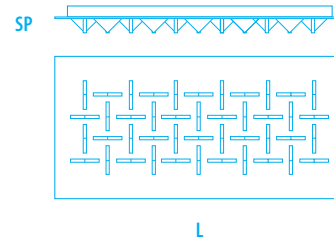

2052/PL110

W 105 - Vac 230

Lm 7.800

M 2.700°K - C 3.000°K

W 4.000°K

L 500 x 1100 mm

SP 80 mm

DIMMERABILE / DIMMABLE

- 2052/PL110-D1 PUSH
- 2052/PL110-D2 1-10V
- 2052/PL110-D3 DALI
- 2052/PL110-D4 Taglio di fase / Phase cut
- 2052/PL110-D7 ZigBee
- 2052/PL110-D8 CASAMBI

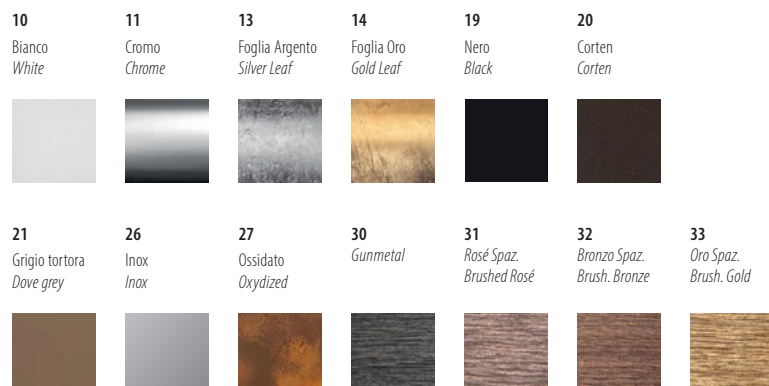

CRISTALLI

CRI > 90

DIMMERABILE / DIMMABLE

Vai a pagina / Go to page 457

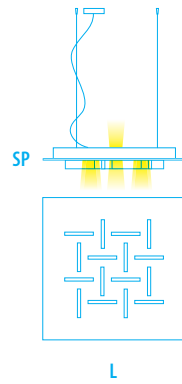

2051/S50

SOTTO / DOWN
W 35 - Vac 230
Lm 3.000

SOPRA / UP
W 7 - Vac 230
Lm 600

M 2.700°K - C 3.000°K
W 4.000°K

L 500 x 500 mm
SP 60 mm
L CAVI / CABLES 2.000 mm

DIMMERABILE / DIMMABLE

- 2051/S50-D1 PUSH
- 2051/S50-D2 1-10V
- 2051/S50-D3 DALI
- 2051/S50-D4 Taglio di fase / Phase cut
- 2051/S50-D7 ZigBee
- 2051/S50-D8 CASAMBI

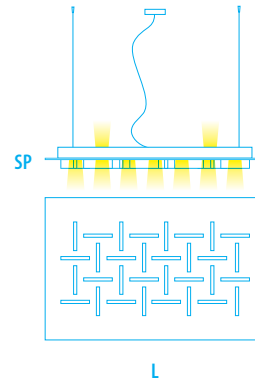

2051/S80

SOTTO / DOWN
W 70 - Vac 230
Lm 6.000

SOPRA / UP
W 14 - Vac 230
Lm 1.200

M 2.700°K - C 3.000°K
W 4.000°K

L 500 x 800 mm
SP 70 mm
L CAVI / CABLES 2.000 mm

DIMMERABILE / DIMMABLE

- 2051/S80-D1 PUSH
- 2051/S80-D2 1-10V
- 2051/S80-D3 DALI
- 2051/S80-D4 Taglio di fase / Phase cut
- 2051/S80-D7 ZigBee
- 2051/S80-D8 CASAMBI

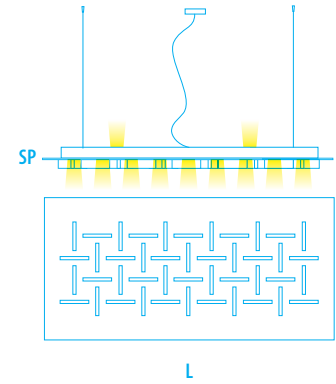

2051/S110

SOTTO / DOWN
W 105 - Vac 230
Lm 9.000

SOPRA / UP
W 14 - Vac 230
Lm 1.200

M 2.700°K - C 3.000°K
W 4.000°K

L 500 x 1.100 mm
SP 70 mm
L CAVI / CABLES 2.000 mm

DIMMERABILE / DIMMABLE

- 2051/S110-D1 PUSH
- 2051/S110-D2 1-10V
- 2051/S110-D3 DALI
- 2051/S110-D4 Taglio di fase / Phase cut
- 2051/S110-D7 ZigBee
- 2051/S110-D8 CASAMBI

284

DIFFUSORE / DIFFUSER

2051 T

Metacrilato trasparente
Transparent-finish methacrylate



2051 S

Metacrilato satinato
Satin-finish methacrylate



2052 T

Metacrilato trasparente
Transparent-finish methacrylate



2052 S

Metacrilato satinato
Satin-finish methacrylate



ESEMPIO D'ORDINE - EXAPLE OF ORDER

ART. 2052/PL50 S C 10

S = Colore Metacrilato Methacrylate Colour: **Satinato Satin**

C = Colore LED LED Colour: **3.000°K**

10 = Colore Struttura Structure Colour: **Bianco White**

10

Bianco
White



11

Cromo
Chrome



13

Foglia Argento
Silver Leaf



14

Foglia Oro
Gold Leaf



19

Nero
Black



20

Corten
Corten



21

Grigio tortora
Dove grey



26

Inox
Inox



27

Ossidato
Oxydized



30

Gunmetal



31

Rosé Spaz.
Brushed Rosé



32

Bronzo Spaz.
Brush. Bronze



33

Oro Spaz.
Brush. Gold







CRISTALLI

CRI > 90

DIMMERABILE / DIMMABLE

Vai a pagina / Go to page 457

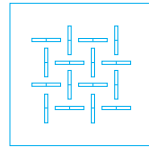
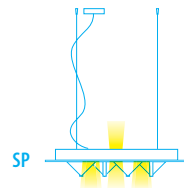

L

2052/S 50

SOTTO / DOWN

W 35 - Vac 230

Lm 2.600

SOPRA / UP

W 7 - Vac 230

Lm 500

M 2.700°K - C 3.000°K

W 4.000°K

L 500 x 500 mm

SP 80 mm

L CAVI / CABLES 2.000 mm

DIMMERABILE / DIMMABLE

- 2052/S50-D1 PUSH
- 2052/S50-D2 1-10V
- 2052/S50-D3 DALI
- 2052/S50-D4 Taglio di fase / Phase cut
- 2052/S50-D7 ZigBee
- 2052/S50-D8 CASAMBI

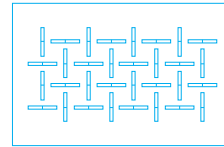
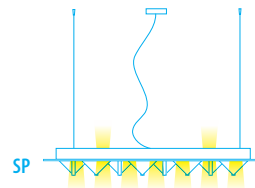

L

2052/S 80

SOTTO / DOWN

W 70 - Vac 230

Lm 5.200

SOPRA / UP

W 14 - Vac 230

Lm 1.000

M 2.700°K - C 3.000°K

W 4.000°K

L 500 x 800 mm

SP 80 mm

L CAVI / CABLES 2.000 mm

DIMMERABILE / DIMMABLE

- 2052/S80-D1 PUSH
- 2052/S80-D2 1-10V
- 2052/S80-D3 DALI
- 2052/S80-D4 Taglio di fase / Phase cut
- 2052/S80-D7 ZigBee
- 2052/S80-D8 CASAMBI

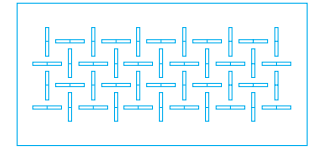
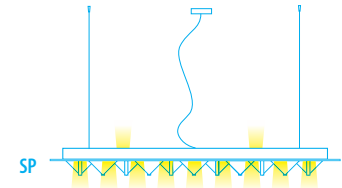

L

2052/S 110

SOTTO / DOWN

W 105 - Vac 230

Lm 7.800

SOPRA / UP

W 14 - Vac 230

Lm 1.000

M 2.700°K - C 3.000°K

W 4.000°K

L 500 x 1.100 mm

SP 80 mm

L CAVI / CABLES 2.000 mm

DIMMERABILE / DIMMABLE

- 2052/S110-D1 PUSH
- 2052/S110-D2 1-10V
- 2052/S110-D3 DALI
- 2052/S110-D4 Taglio di fase / Phase cut
- 2052/S110-D7 ZigBee
- 2052/S110-D8 CASAMBI

287

DIFFUSORE / DIFFUSER

2051 T

Metacrilato trasparente
Transparent-finish methacrylate



2051 S

Metacrilato satinato
Satin-finish methacrylate



2052 T

Metacrilato trasparente
Transparent-finish methacrylate



2052 S

Metacrilato satinato
Satin-finish methacrylate



ESEMPIO D'ORDINE / EXAPLE OF ORDER

ART. 2052/PL50 S C 10

S = Colore Metacrilato Methacrylate Colour: **Satinato Satin**

C = Colore LED LED Colour: **3.000°K**

10 = Colore Struttura Structure Colour: **Bianco White**

10

Bianco
White



11

Cromo
Chrome



13

Foglia Argento
Silver Leaf



14

Foglia Oro
Gold Leaf



19

Nero
Black



20

Corten
Corten



21

Grigio tortora
Dove grey



26

Inox
Inox



27

Ossidato
Oxydized



30

Gunmetal



31

Rosé Spaz.
Brushed Rosé



32

Bronzo Spaz.
Brush. Bronze



33

Oro Spaz.
Brush. Gold



Gamma

288

2080/S

BRAGA LED





290

2080/PL50

BRAGA LED







292

GAMMA

CRI > 90

DIMMERABILE / DIMMABLE

Vai a pagina / Go to page 457

DIFFUSORE / DIFFUSER

Metacrilato opalino

Opal-finish methacrylate

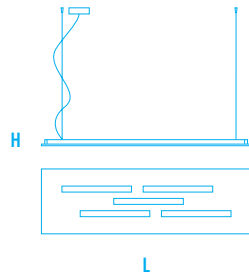

2080/S

SOTTO/DOWN

W 63 - Vac 230

Lm 6.000

M 2.700°K - C 3.000°K - W 4.000°K

SOPRA/UP

W 9 - Vac 230

Lm 600 - C 3.000°K

L 910 x 300 mm

H 26 mm

L CAVI / CABLES 2.000 mm

DOPPIA ACCENSIONE / DOUBLE SWITCH

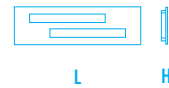

2080/A2

W 25 - Vac 230

Lm 2.400

M 2.700°K - C 3.000°K - W 4.000°K

L 530 x 150 mm

H 26 mm

DIMMERABILE / DIMMABLE

2080/A2-D1 PUSH

2080/A2-D2 1-10V

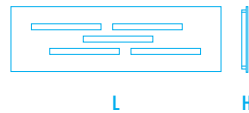

2080/PL90

W 63 - Vac 230

Lm 6.000

M 2.700°K - C 3.000°K - W 4.000°K

L 910 x 300 mm

H 26 mm

DIMMERABILE / DIMMABLE

2080/PL90-D1 PUSH

2080/PL90-D2 1-10V

2080/PL90-D3 DALI

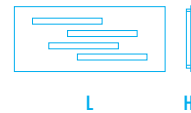

2080/PL65

W 50 - Vac 230

Lm 4.800

M 2.700°K - C 3.000°K - W 4.000°K

L 660 x 300 mm

H 26 mm

DIMMERABILE / DIMMABLE

2080/PL65-D1 PUSH

2080/PL65-D2 1-10V

2080/PL65-D3 DALI

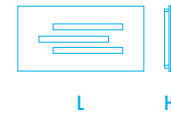

2080/PL50

W 38 - Vac 230

Lm 3.600

M 2.700°K - C 3.000°K - W 4.000°K

L 530 x 300 mm

H 26 mm

DIMMERABILE / DIMMABLE

2080/PL50-D1 PUSH

2080/PL50-D2 1-10V

2080/PL50-D3 DALI

10

Bianco
White



13

Foglia Argento
Silver Leaf



14

Foglia Oro
Gold Leaf



20

Corten
Corten



21

Grigio tortora
Dove grey



294

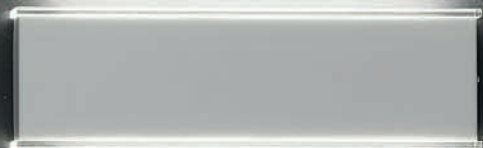

2080/A

BRAGA LED



GAMMA

CRI > 90

DIMMERABILE / DIMMABLE

Vai a pagina / Go to page 457

DIFFUSORE / DIFFUSER

Metacrilato satinato

Satin-finish methacrylate

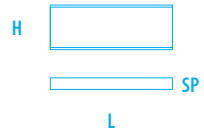

2080/A

W 25 - Vac 230

Lm 2.400

M 2.700°K - C 3.000°K - W 4.000°K











L 300 x H 95 mm

SP 38 mm

DIMMERABILE / DIMMABLE

2080/A-D1 PUSH

2080/A-D2 1-10V

| | | | | |
|---|---|---|--|---|
| 10 Bianco <i>White</i> | 11 Cromo <i>Chrome</i> | 13 Foglia Argento <i>Silver Leaf</i> | 14 Foglia Oro <i>Gold Leaf</i> | 20 Corten <i>Corten</i> |
|  |  |  |  |  |
| 21 Grigio tortora <i>Dove grey</i> | 30 Gunmetal | 31 Rosé Spaz. <i>Brushed Rosé</i> | 32 Bronzo Spaz. <i>Brush. Bronze</i> | 33 Oro Spaz. <i>Brush. Gold</i> |
|  |  |  |  |  |

Candy

296



2118/PL70

BRAGA LED



298



2118/PL55

BRAGA LED

CANDY

CRI > 80

DIMMERABILE / DIMMABLE

Vai a pagina / Go to page 462

DIFFUSORE / DIFFUSER

Vetro extrachiaro bianco

White extra clear glass



299

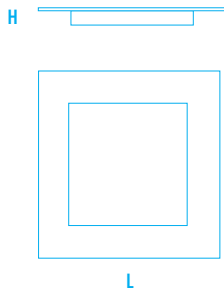

2118/PL 70

W 43 - Vac 230

Lm 2.900

M 2.700°K - C 3.000°K - W 4.000°K

L 700 x 700 mm

H 55 mm

DIMMERABILE / DIMMABLE
TAGLIO DI FASE / PHASE CUT

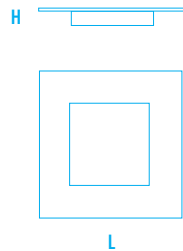

2118/PL 55

W 30 - Vac 230

Lm 2.300

M 2.700°K - C 3.000°K - W 4.000°K

L 550 x 550 mm

H 55 mm

DIMMERABILE / DIMMABLE
TAGLIO DI FASE / PHASE CUT

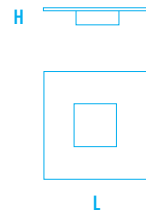

2118/PL 40

W 20 - Vac 230

Lm 1.400

M 2.700°K - C 3.000°K - W 4.000°K

L 400 x 400 mm

H 55 mm

DIMMERABILE / DIMMABLE
TAGLIO DI FASE / PHASE CUT

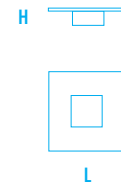

2118/PL 30

W 15 - Vac 230

Lm 950

M 2.700°K - C 3.000°K - W 4.000°K

L 300 x 300 mm

H 55 mm

DIMMERABILE / DIMMABLE
TAGLIO DI FASE / PHASE CUT

10

Bianco
White



13

Foglia Argento
Silver Leaf



14

Foglia Oro
Gold Leaf



20

Corten
Corten



21

Grigio tortora
Dove grey



27

Ossidato
Oxydized



34

Rosè Verniciato
Painted Rosè



35

Bronzo Verniciato
Bronze Painted





300

2118/A1

BRAGA LED

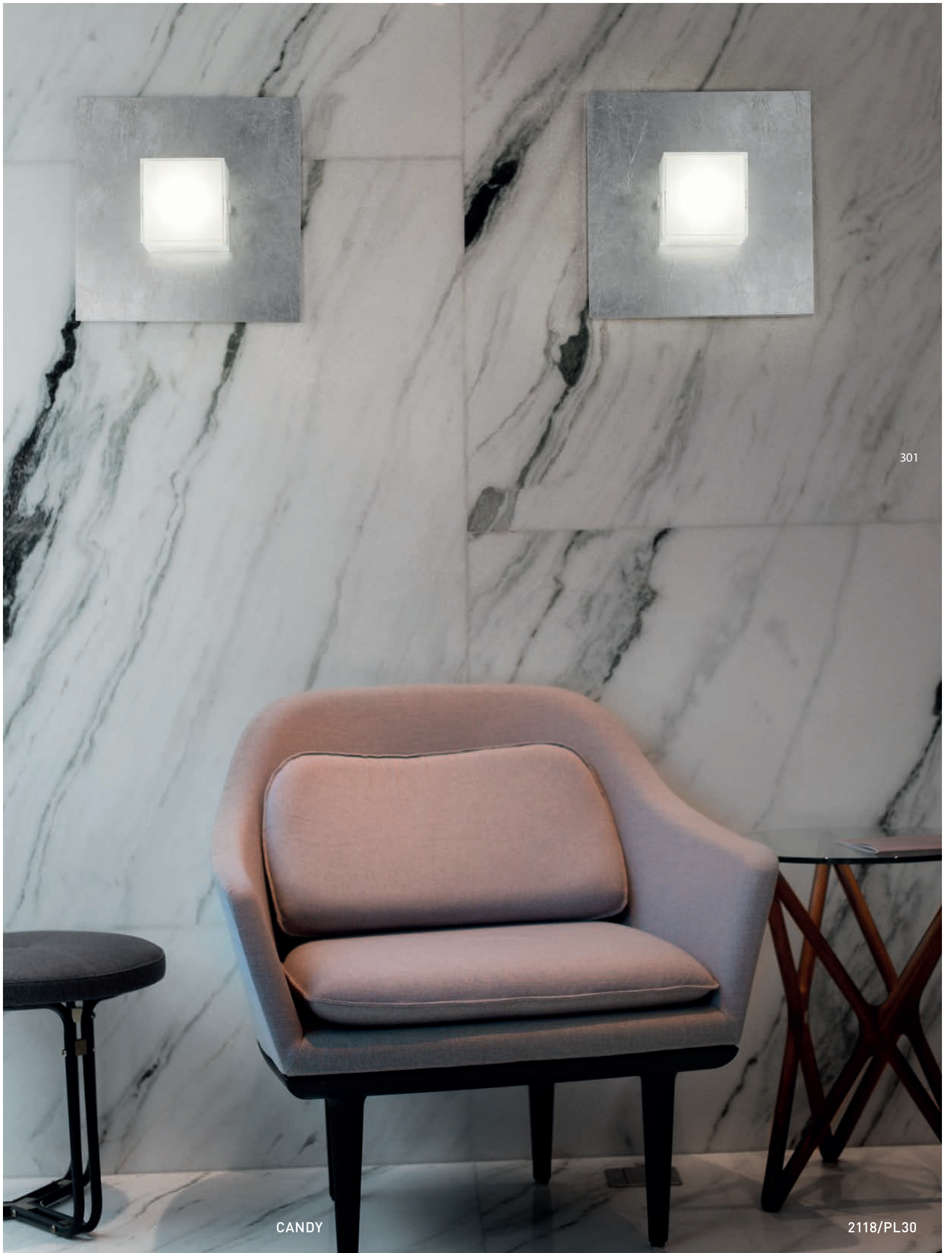

301

CANDY

2118/PL30



302

2118/A1

BRAGA LED

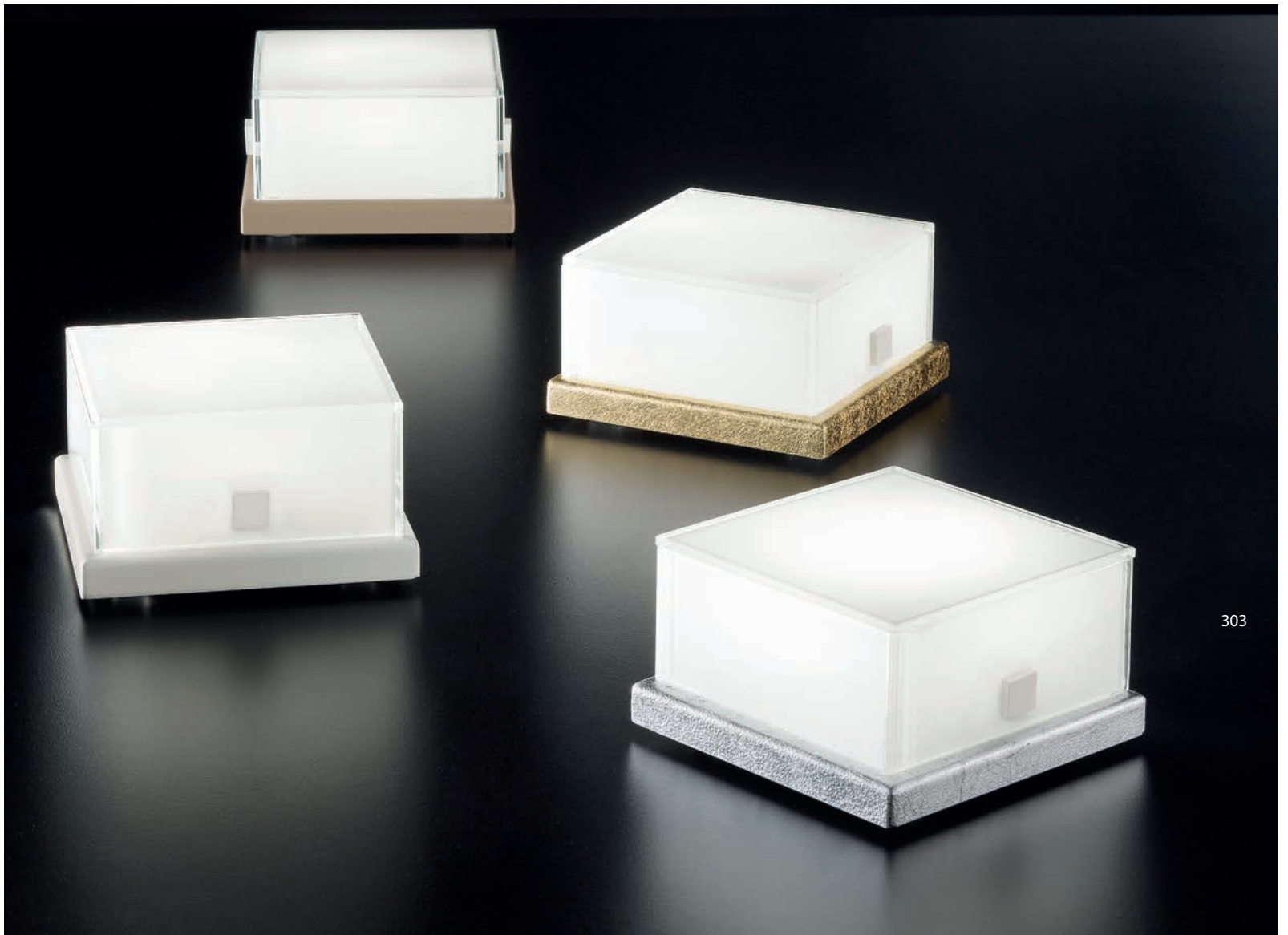

CRI > 80

DIMMERABILE / DIMMABLE

Vai a pagina / Go to page 462

DIFFUSORE / DIFFUSER

Vetro extrachiaro bianco
White extra clear glass

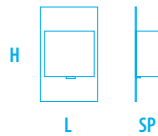

2118/A1

W 15 - Vac 230
Lm 950
M 2.700°K - C 3.000°K - W 4.000°K

L 250 x 150 mm
H 55 mm

DIMMERABILE / DIMMABLE
TAGLIO DI FASE / PHASE CUT



2118/L

W 15 - Vac 230
Lm 950
M 2.700°K - C 3.000°K - W 4.000°K

L 120 x 120 mm
H 67 mm

CON DIMMER / WITH DIMMER



Puzzle

304





306



2111/PL50 - 2111/PL60

BRAGA LED

PUZZLE

CRI > 80

DIMMERABILE / DIMMABLE

Vai a pagina / Go to page 462

DIFFUSORE / DIFFUSER

Metacrilato opalino

Opal-finish methacrylate

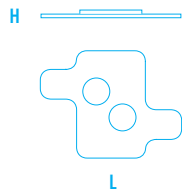

2111/PL 50

W 30 - **Vac** 230

Lm 2.150

M 2.700°K - **C** 3.000°K - **W** 4.000°K

L 500x360 mm

H 28 mm

DIMMERABILE / DIMMABLE
TAGLIO DI FASE / PHASE CUT

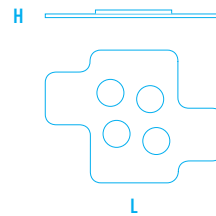

2111/PL 60

W 60 - **Vac** 230

Lm 4.300

M 2.700°K - **C** 3.000°K - **W** 4.000°K

L 600x450 mm

H 33 mm

DIMMERABILE / DIMMABLE
TAGLIO DI FASE / PHASE CUT

10

Bianco
White



13

Foglia Argento
Silver Leaf



14

Foglia Oro
Gold Leaf



20

Corten
Corten



21

Grigio tortora
Dove grey



27

Ossidato
Oxydized



Nuvola

308



2092/PL70

BRAGA LED





310



311

NUVOLA

2092/PL70



NUVOLA

CRI > 80

DIMMERABILE / DIMMABLE

Vai a pagina / Go to page 462

DIFFUSORE / DIFFUSER

Metacrilato opalino

Opal-finish methacrylate

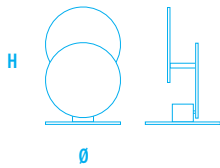

2092/L

W 4 - Vac 230

Lm 300

M 2.700°K - C 3.000°K - W 4.000°K

Ø 150 mm

H 240 mm



313

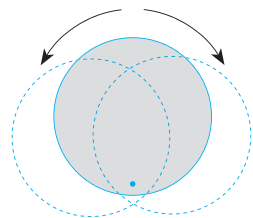

**DISCHI ORIENTABILI
ADJUSTABLE DISCS**

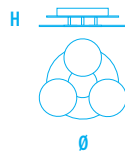

2092/PL35

W 17 - Vac 230

Lm 1.200

M 2.700°K - C 3.000°K - W 4.000°K

Ø 350 mm

H 110 mm

**DIMMERABILE / DIMMABLE
TAGLIO DI FASE / PHASE CUT**

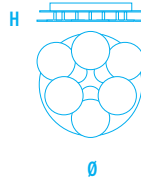

2092/PL45

W 30 - Vac 230

Lm 2.300

M 2.700°K - C 3.000°K - W 4.000°K

Ø 450 mm

H 110 mm

**DIMMERABILE / DIMMABLE
TAGLIO DI FASE / PHASE CUT**

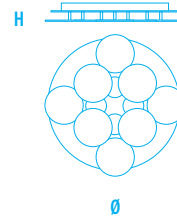

2092/PL60

W 40 - Vac 230

Lm 3.000

M 2.700°K - C 3.000°K - W 4.000°K

Ø 600 mm

H 120 mm

**DIMMERABILE / DIMMABLE
TAGLIO DI FASE / PHASE CUT**

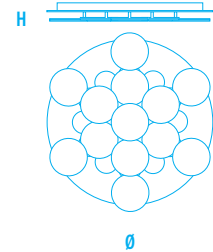

2092/PL70

W 72 - Vac 230

Lm 5.500

M 2.700°K - C 3.000°K - W 4.000°K

Ø 700 mm

H 120 mm

**DIMMERABILE / DIMMABLE
TAGLIO DI FASE / PHASE CUT**

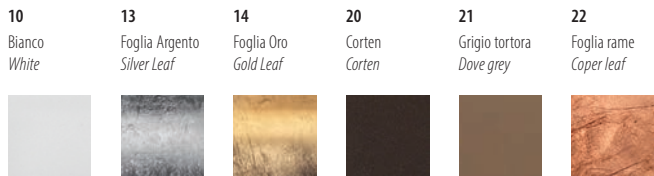

10
Bianco
White

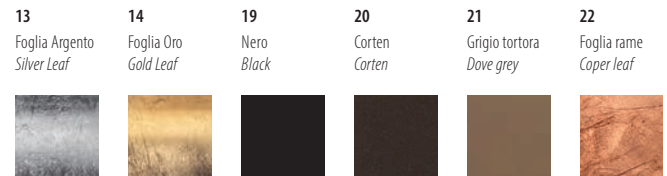

19
Nero
Black



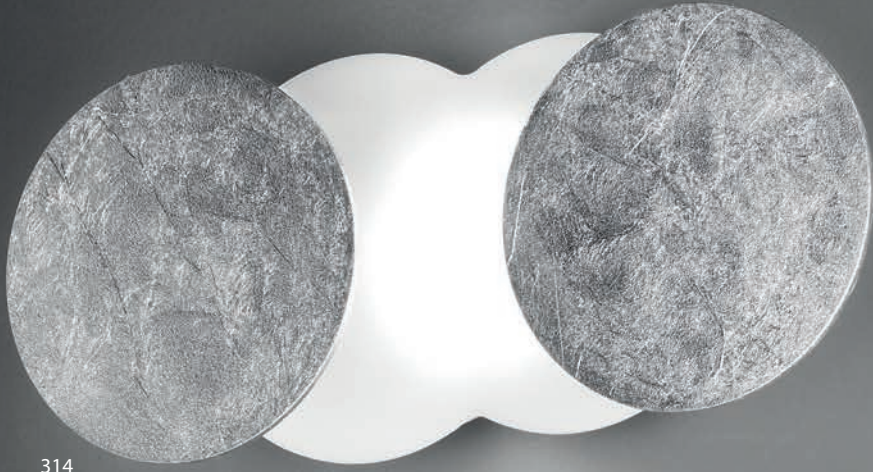

314

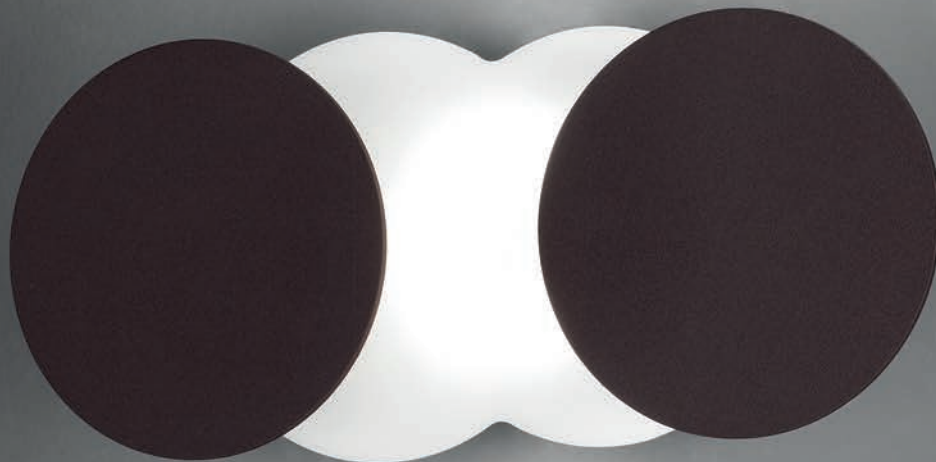
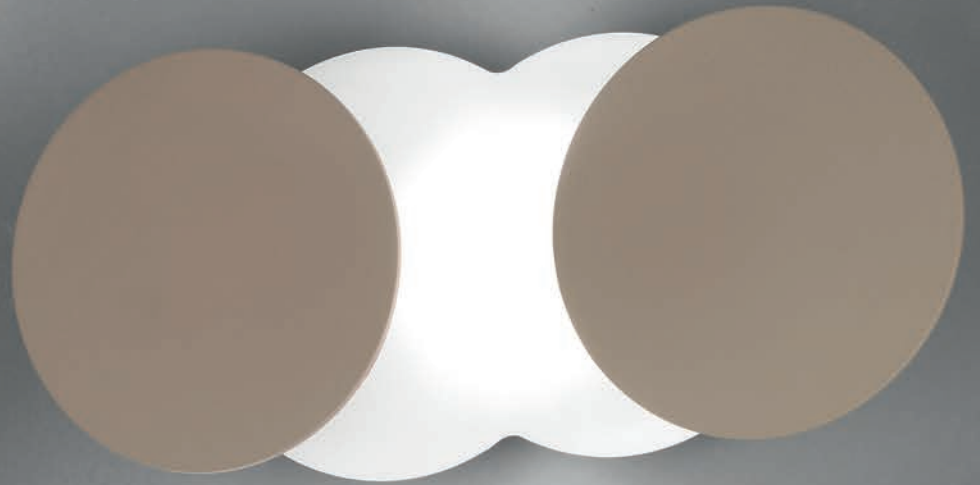

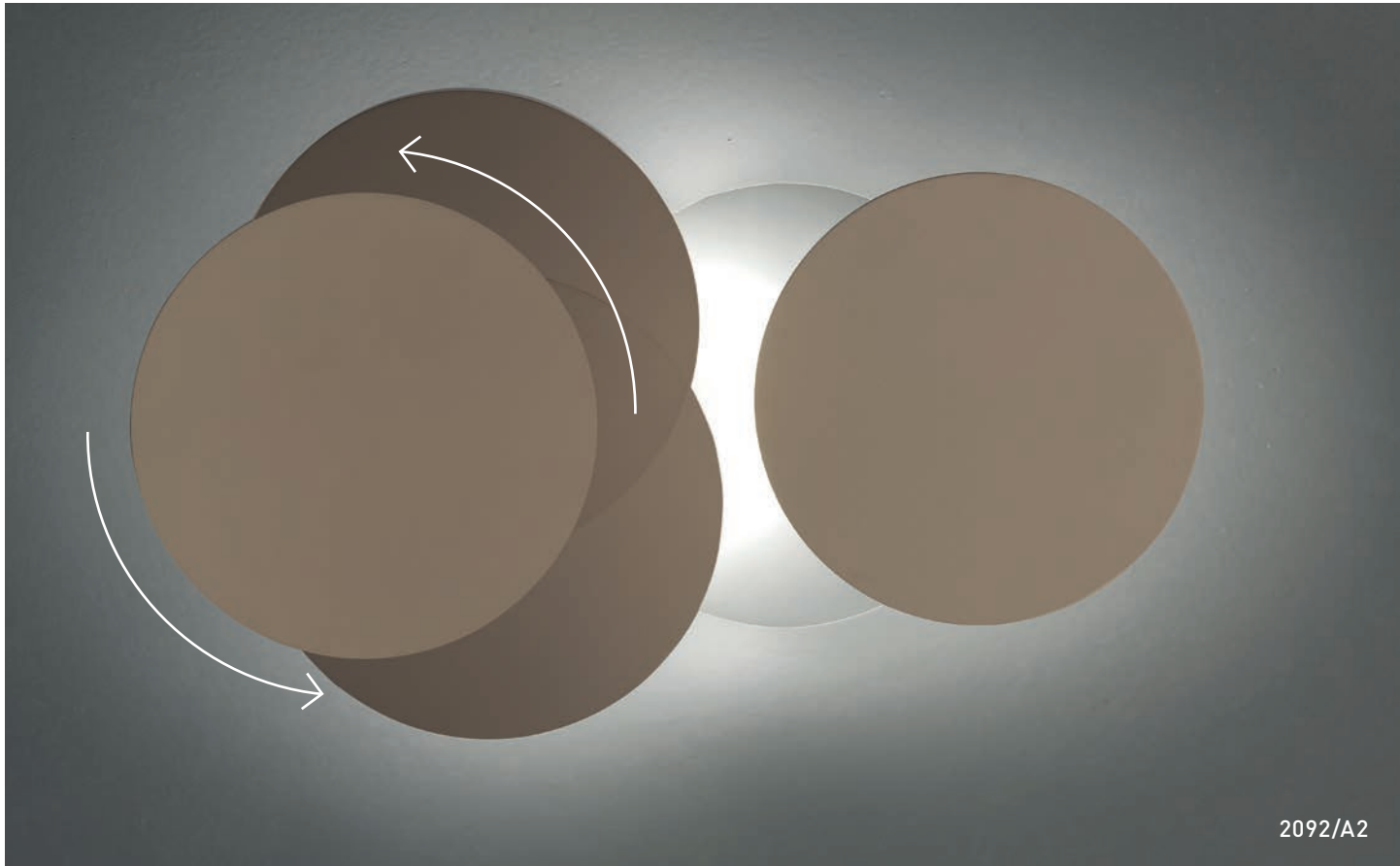

2092/A2

CRI > 80

DIFFUSORE / DIFFUSER

Metacrilato opalino
Opal-finish methacrylate

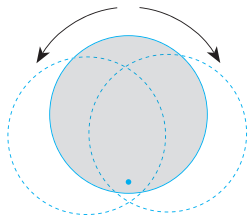

**DISCHI ORIENTABILI
ADJUSTABLE DISCS**

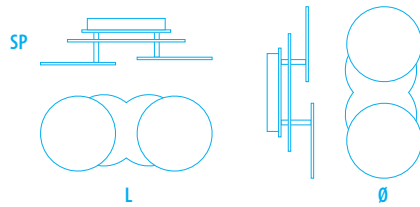

2092/A2

W 17 - Vac 230

Lm 1.200

M 2.700°K - C 3.000°K - W 4.000°K

L MAX 350 mm

L MIN 250 mm

Ø 150 mm

SP 80 mm

**DIMMERABILE / DIMMABLE
TAGLIO DI FASE / PHASE CUT**

Vai a pagina / Go to page 462

| | | | | | |
|---|---|---|--|---|---|
| 10 Bianco White | 13 Foglia Argento Silver Leaf | 14 Foglia Oro Gold Leaf | 20 Corten Corten | 21 Grigio tortora Dove grey | 22 Foglia rame Coper leaf |
|  |  |  |  |  |  |

10
Bianco
White



Pianeta

316



2106/PL80

BRAGA LED





PIANETA



319

2106/PL45

CRI > 80

DIMMERABILE / DIMMABLE

Vai a pagina / Go to page 462

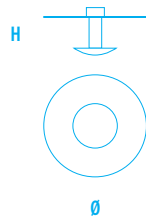

2106/PL45

W 30 - Vac 230

Lm 2.300

M 2.700°K - C 3.000°K - W 4.000°K

Ø 450 mm

H 150 mm

DIMMERABILE / DIMMABLE
TAGLIO DI FASE / PHASE CUT

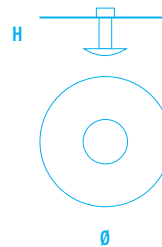

2106/PL60

W 30 - Vac 230

Lm 2.300

M 2.700°K - C 3.000°K - W 4.000°K

Ø 600 mm

H 150 mm

DIMMERABILE / DIMMABLE
TAGLIO DI FASE / PHASE CUT

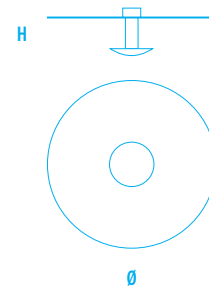

2106/PL80

W 30 - Vac 230

Lm 2.300

M 2.700°K - C 3.000°K - W 4.000°K

Ø 800 mm

H 150 mm

DIMMERABILE / DIMMABLE
TAGLIO DI FASE / PHASE CUT

10

Bianco
White



13

Foglia Argento
Silver Leaf



14

Foglia Oro
Gold Leaf



Rotary

320



2116/PL60

BRAGA LED



321

ROTARY

2116/PL50

322

2116/PL35

BRAGA LED





CRI > 80

DIMMERABILE / DIMMABLE

Vai a pagina / Go to page 462

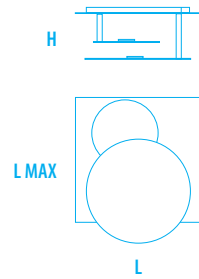

2116/PL 35

W 40 - Vac 230
 Lm 2.900
 M 2.700°K - C 3.000°K - W 4.000°K
 L 350 x 350 mm
 L MAX 500 mm
 H 150 mm

DIMMERABILE / DIMMABLE
 TAGLIO DI FASE / PHASE CUT

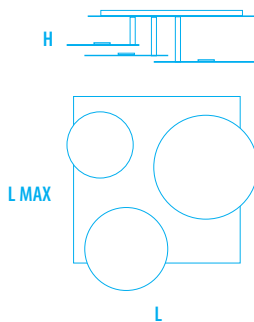

2116/PL 50

W 45 - Vac 230
 Lm 3.300
 M 2.700°K - C 3.000°K - W 4.000°K
 L 400 x 400 mm
 L MAX 600 mm
 H 160 mm

DIMMERABILE / DIMMABLE
 TAGLIO DI FASE / PHASE CUT

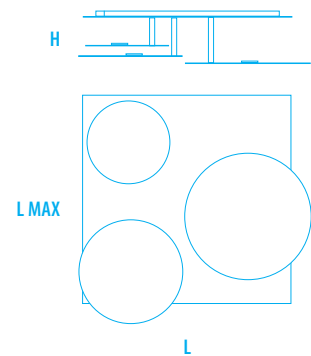

2116/PL 60

W 60 - Vac 230
 Lm 4.350
 M 2.700°K - C 3.000°K - W 4.000°K
 L 500 x 500 mm
 L MAX 700 mm
 H 190 mm

DIMMERABILE / DIMMABLE
 TAGLIO DI FASE / PHASE CUT

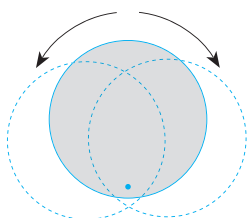

DISCHI ORIENTABILI
 ADJUSTABLE DISCS

10
 Bianco
 White



13
 Foglia Argento
 Silver Leaf



14
 Foglia Oro
 Gold Leaf



324



2116/A

BRAGA LED

ROTARY

CRI > 80

DIMMERABILE / DIMMABLE

Vai a pagina / Go to page 462



325

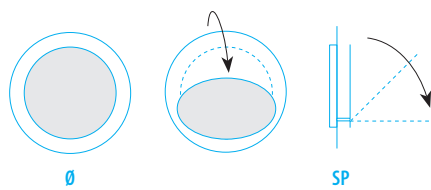

2116/A

W 20 - Vac 230
Lm 1.450
M 2.700°K - C 3.000°K - W 4.000°K

Ø 250 mm
SP MAX 230 mm

DIMMERABILE / DIMMABLE
TAGLIO DI FASE / PHASE CUT

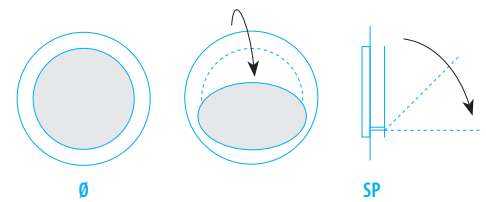

2116/A2

W 20 - Vac 230
Lm 1.450
M 2.700°K - C 3.000°K - W 4.000°K

Ø 360 mm
SP MAX 300 mm

DIMMERABILE / DIMMABLE
TAGLIO DI FASE / PHASE CUT

10

Bianco
White



13

Foglia Argento
Silver Leaf



14

Foglia Oro
Gold Leaf



Time

326



2107/PL80

BRAGA LED

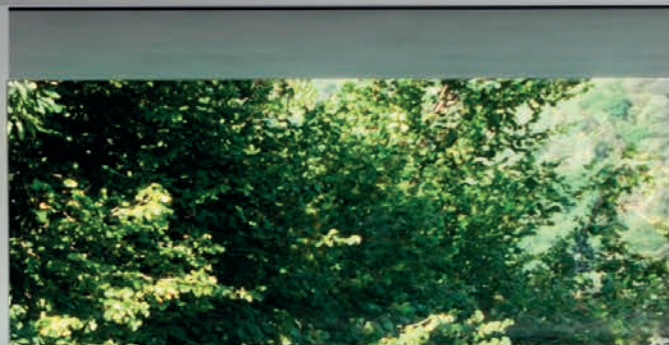



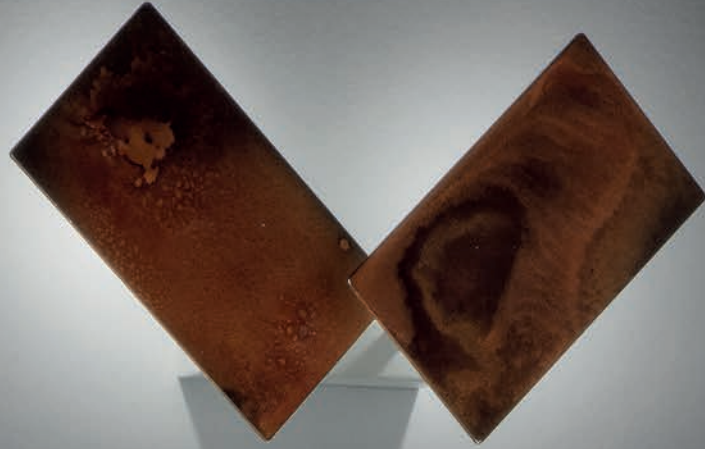

328

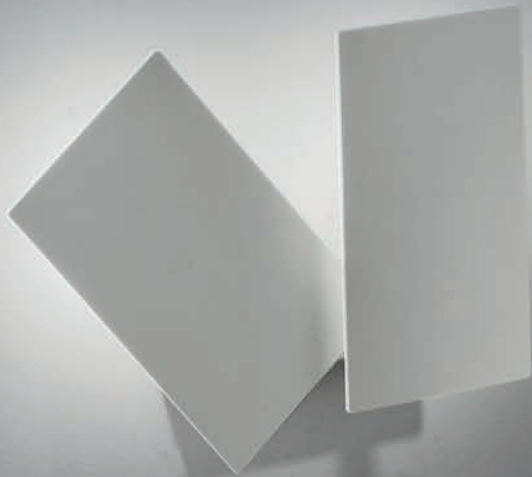



329

TIME

2107/PL50

330

2107/L

BRAGA LED



TIME

CRI > 80

DIMMERABILE / DIMMABLE

Vai a pagina / Go to page 462

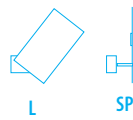

2107/A1

W 20 - Vac 230
 Lm 1.500
 M 2.700°K - C 3.000°K - W 4.000°K
 L 185 x 105 mm
 SP 90 mm

DIMMERABILE / DIMMABLE
TAGLIO DI FASE / PHASE CUT

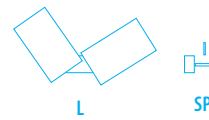

2107/A2

W 30 - Vac 230
 Lm 2.300
 M 2.700°K - C 3.000°K - W 4.000°K
 L MIN 200 MAX 400 mm
 SP 90 mm

DIMMERABILE / DIMMABLE
TAGLIO DI FASE / PHASE CUT

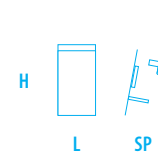

2107/L

W 10 - Vac 230
 Lm 750
 M 2.700°K - C 3.000°K - W 4.000°K
 L 185 x 105 mm
 SP 110 mm

CON DIMMER / WITH DIMMER

331

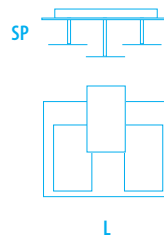

2107/PL40

W 30 - Vac 230
 Lm 2.300
 M 2.700°K - C 3.000°K - W 4.000°K
 L 400 x 290 mm
 SP 200 mm

DIMMERABILE / DIMMABLE
TAGLIO DI FASE / PHASE CUT

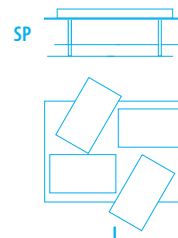

2107/PL50

W 40 - Vac 230
 Lm 3.000
 M 2.700°K - C 3.000°K - W 4.000°K
 L 500 x 350 mm
 SP 200 mm

DIMMERABILE / DIMMABLE
TAGLIO DI FASE / PHASE CUT

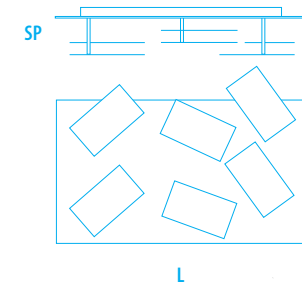

2107/PL80

W 60 - Vac 230
 Lm 4.600
 M 2.700°K - C 3.000°K - W 4.000°K
 L 800 x 450 mm
 SP 200 mm

DIMMERABILE / DIMMABLE
TAGLIO DI FASE / PHASE CUT

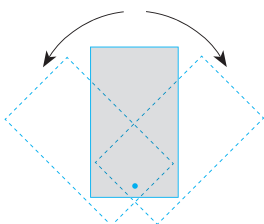

ELEMENTI ORIENTABILI
 ADJUSTABLE ELEMENTS

10
 Bianco
 White



13
 Foglia Argento
 Silver Leaf



14
 Foglia Oro
 Gold Leaf



20
 Corten
 Corten



21
 Grigio tortora
 Dove grey



22
 Foglia rame
 Copper leaf



27
 Ossidato
 Oxydized



Up & Down



332

2147/150 + N°3 2150/1 + N°3 2150/3 + 2150/2 + 2150/4 + N°4 2150/S2

BRAGA LED



334



2150/S + 2150/4 + 2146/R1

BRAGA LED



335

UP & DOWN

2146/PL4 + N°3 2150/S + N°3 2150/1 + N°2 2150/3 + 2150/S2







UP & DOWN

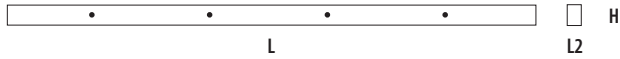

2147/150

L 1.500
L2 30 mm
H 47 mm

Numero di fori per sospensioni su richiesta / Number of holes for pendants on request

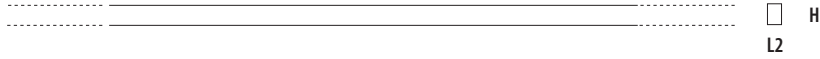

2147/50

L 500 mm
L2 30 mm
H 47 mm

2147/100

L 1.000 mm
L2 30 mm
H 47 mm

2147/200

L 2.000 mm
L2 30 mm
H 47 mm

2147/250

L 2.500 mm
L2 30 mm
H 47 mm

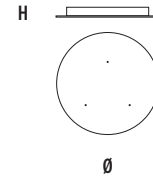

2146/PL30

Ø 300 mm
H 37 mm

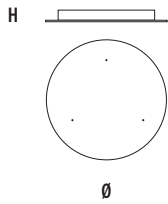

2146/PL3

Ø 440 mm
H 60 mm

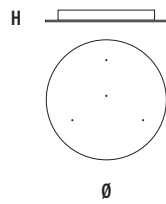

2146/PL4

Ø 440 mm
H 60 mm

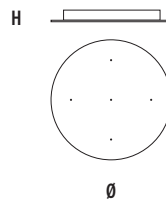

2146/PL5

Ø 440 mm
H 60 mm

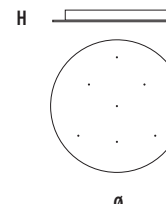

2146/PL7

Ø 560 mm
H 60 mm

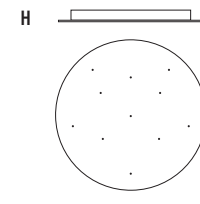

2146/PL11

Ø 700 mm
H 60 mm



2146/N

Ø 20 mm
H 15 mm

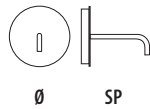

2146/A

Ø 120 mm
SP 150 mm

Per/For 2150/1-2

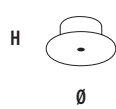

2146/R1

Ø 105 mm
H 30 mm

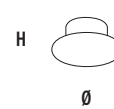

2146/R6

Ø 140 mm
H 30 mm

Rosone per collegamento da 2 a 6
Canopy for connection from 2 to 6

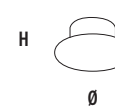

2146/R12

Ø 175 mm
H 30 mm

Rosone per collegamento da 2 a 12
Canopy for connection from 2 to 12

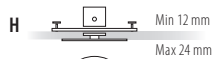

Ø

Rosone da incasso
Recessed canopy
Max 3,2 Kg

2146/R35

Ø 45 mm
H 35 mm
Ø 35 mm

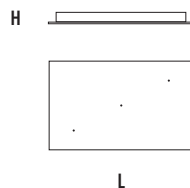

2145/PL50/3

L 530 x 300 mm
H 45 mm

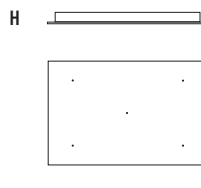

2145/PL80/5

L 800 x 500 mm
H 45 mm

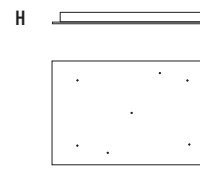

2145/PL80/7

L 800 x 500 mm
H 45 mm

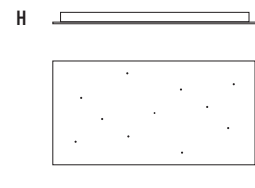

2145/PL110/11

L 1.100 x 500 mm
H 45 mm



UP & DOWN

340

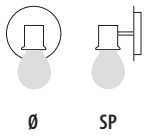

2150/A1

1 x max 70W E27 

o/or
LED

Ø 140 mm
SP 125 mm

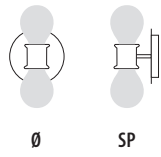

2150/A2

2 x max 70W E27 

o/or
LED

Ø 140 mm
SP 125 mm

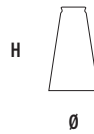

2150/1

Ø 135 mm
H 210 mm

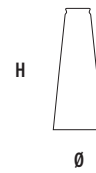

2150/3

Ø 135 mm
H 305 mm





341

UP & DOWN

2150/A2 + N°2 2150/3

UP & DOWN

342

2150/S
 1 x max 70W E27
 o/or
LED
 Ø 90 mm
 H 85 mm
 L CAVI / CABLES 3.000 mm

2150/S2
 1 x max 42W E14
 o/or
LED
 +
 1 x max 70W E27
 o/or
LED
 H 260 mm
 L CAVI / CABLES 3.000 mm
DOPPIA ACCENSIONE / DOUBLE SWITCH

2150/1
 Ø 135 mm
 H 210 mm

2150/2
 Ø 250 mm
 H 190 mm

2150/3
 Ø 135 mm
 H 305 mm

2150/4
 Ø 400 mm
 H 190 mm

| | | | | | | |
|------------------------------|-----------------------------|----------------------------|------------------------------|----------------------------|--------------------------|---|
| 10 Bianco White | 15 Grigio Grey | 19 Nero Black | 23 Ruggine Rust | 24 Ferro Iron | 28 Oro Gold | 29 Alluminio Spaz. Brushed Alum. |
| | | | | | | |

| | | | |
|-----------------------|---|--|---------------------------------------|
| 30 Gunmetal | 31 Rosé Spaz. Brushed Rosé | 32 Bronzo Spaz. Brush. Bronze | 33 Oro Spaz. Brush. Gold |
| | | | |

| | | | |
|------------------------------|--|--------------------------------------|---|
| 10 Bianco White | 13 Foglia Argento Silver Leaf | 14 Foglia Oro Gold Leaf | 22 Foglia rame Copper leaf |
| | | | |

| |
|------------------------------|
| 10 Bianco White |
| |



UP & DOWN

N°2 2150/3 + 2150/S2 + 2146/R1



344

UP & DOWN

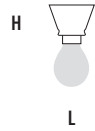

2150/PL

1 x max 70W E27 

o/or
LED

Ø 90 mm
H 85 mm

PER / FOR 2150/1-2-4

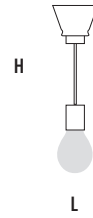

2150/PL3

1 x max 70W E27 

o/or
LED

Ø 90 mm
H 260 mm

PER / FOR 2150/3

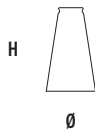

2150/1

Ø 135 mm
H 210 mm

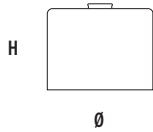

2150/2

Ø 250 mm
H 190 mm

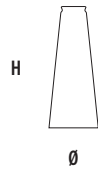

2150/3

Ø 135 mm
H 305 mm

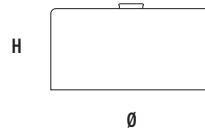

2150/4

Ø 400 mm
H 190 mm

10
Bianco
White



15
Grigio
Grey



19
Nero
Black



23
Ruggine
Rust



24
Ferro
Iron



28
Oro
Gold



29
Alluminio Spaz.
Brushed Alum.



30
Gunmetal



31
Rosé Spaz.
Brushed Rosé



32
Bronzo Spaz.
Brush. Bronze



33
Oro Spaz.
Brush. Gold



10
Bianco
White



13
Foglia Argento
Silver Leaf



14
Foglia Oro
Gold Leaf



22
Foglia rame
Copper leaf



10
Bianco
White





346



N°2 2146/A + 2150/1 + 2150/3 + N°2 2150/S

BRAGA LED

UP & DOWN

POSSIBILITÀ DI COMPOSIZIONE - POSSIBILITY OF COMPOSITION

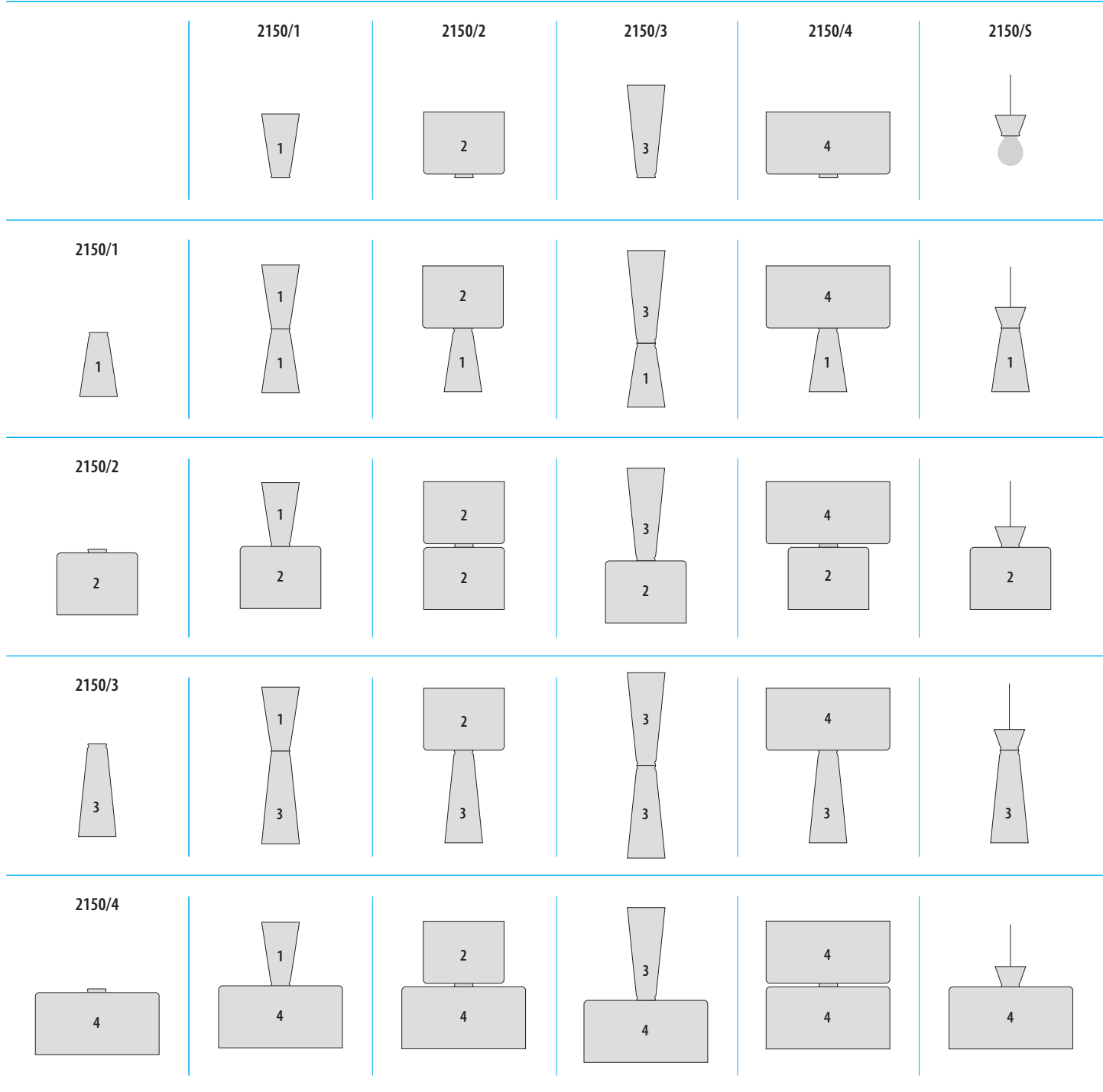

347

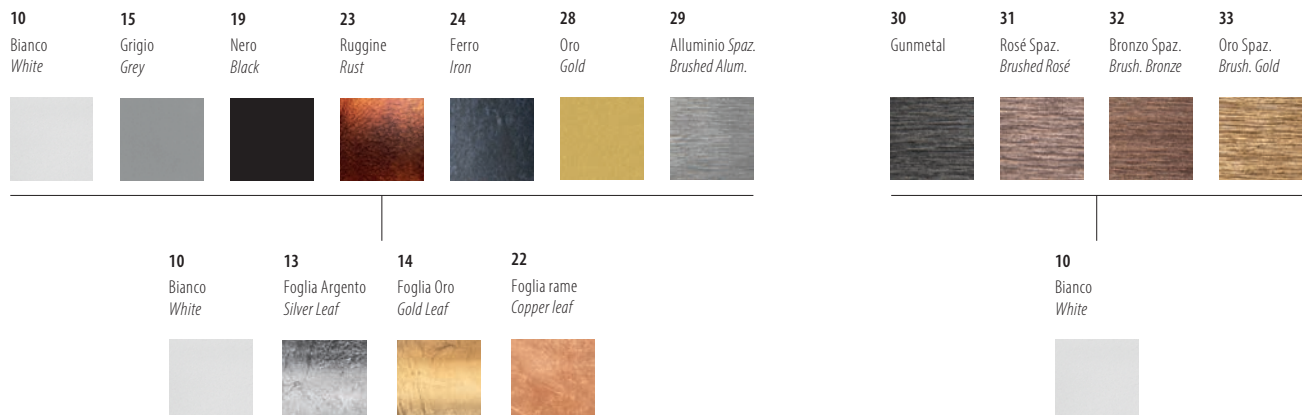

348



2150/T1 + 2150/5 + 2150/2

BRAGA LED

UP & DOWN

ESEMPIO D'ORDINE PAG. 348
 EXAMPLE OF ORDER PAG. 348



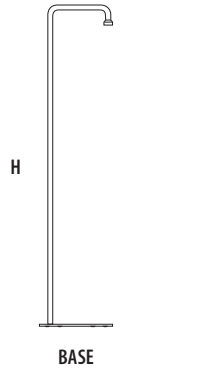

- N.1 2150/T-1-19
- N.1 2150/5-29
- N.1 2150/2-29





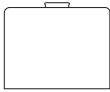

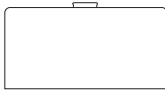
| | |
|--|--|
| <p>10 Bianco White</p>  | <p>19 Nero Black</p>  |
|--|--|

2150/T1
 1 x max 70W E27 
 o/or
LED
 H 1.820 mm
 BASE Ø 320 mm



| | | | | |
|--|--|--|--|--|
|  2150/1 Ø 135 mm H 210 mm |  2150/2 Ø 250 mm H 190 mm |  2150/3 Ø 135 mm H 305 mm |  2150/4 Ø 400 mm H 190 mm |  2150/5 Ø 90 mm H 85 mm |
|--|--|--|--|--|

| | | | | | | | | | | |
|--|--|--|---|--|--|---|--|---|--|---|
| <p>10 Bianco White</p>  | <p>15 Grigio Grey</p>  | <p>19 Nero Black</p>  | <p>23 Ruggine Rust</p>  | <p>24 Ferro Iron</p>  | <p>28 Oro Gold</p>  | <p>29 Alluminio Spaz. Brushed Alum.</p>  | <p>30 Gunmetal</p>  | <p>31 Rosé Spaz. Brushed Rosé</p>  | <p>32 Bronzo Spaz. Brush. Bronze</p>  | <p>33 Oro Spaz. Brush. Gold</p>  |
| <p>10 Bianco White</p>  | <p>13 Foglia Argento Silver Leaf</p>  | <p>14 Foglia Oro Gold Leaf</p>  | <p>22 Foglia rame Copper leaf</p>  | <p>10 Bianco White</p>  | | | | | | |

Geo

350



2123/S60

BRAGA LED



GEO

CRI > 80

DIMMERABILE / DIMMABLE

Vai a pagina / Go to page 462

DIFFUSORE / DIFFUSER

Metacrilato opalino

Opal-finish methacrylate

352

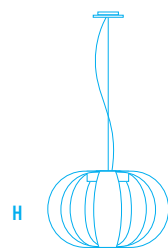

H

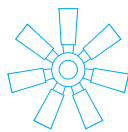

Ø

2123/S 40

W 15 - Vac 230
Lm 1.100
M 2.700°K - C 3.000°K - W 4.000°K

Ø 400 mm
H 250 mm
L CAVI / CABLES 2.000 mm

DIMMERABILE / DIMMABLE
TAGLIO DI FASE / PHASE CUT

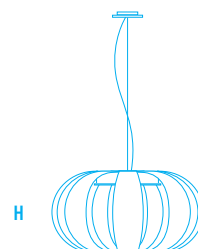

H

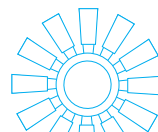

Ø

2123/S 50

W 20 - Vac 230
Lm 1.400
M 2.700°K - C 3.000°K - W 4.000°K

Ø 500 mm
H 250 mm
L CAVI / CABLES 2.000 mm

DIMMERABILE / DIMMABLE
TAGLIO DI FASE / PHASE CUT

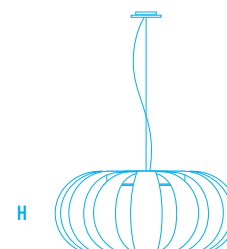

H

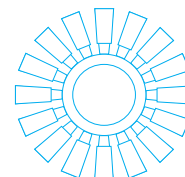

Ø

2123/S 60

W 30 - Vac 230
Lm 2.300
M 2.700°K - C 3.000°K - W 4.000°K

Ø 600 mm
H 250 mm
L CAVI / CABLES 2.000 mm

DIMMERABILE / DIMMABLE
TAGLIO DI FASE / PHASE CUT

10
Bianco
White
/

10
Bianco
White
/

10
Bianco
White
/

19
Nero
Black
/

19
Nero
Black
/

19
Nero
Black
/

10
Bianco
White

13
Foglia Argento
Silver Leaf

14
Foglia Oro
Gold Leaf

13
Foglia Argento
Silver Leaf

14
Foglia Oro
Gold Leaf

19
Nero
Black





354



2123/PL40

BRAGA LED

GEO

CRI > 80

DIMMERABILE / DIMMABLE

Vai a pagina / Go to page 462

DIFFUSORE / DIFFUSER

Metacrilato opalino

Opal-finish methacrylate

355

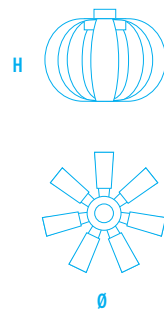

2123/PL 40

W 15 - **Vac** 230
Lm 1.100
M 2.700°K - **C** 3.000°K - **W** 4.000°K
Ø 400 mm
H 250 mm

DIMMERABILE / DIMMABLE
TAGLIO DI FASE / PHASE CUT

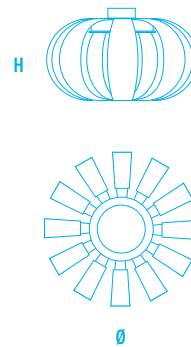

2123/PL 50

W 20 - **Vac** 230
Lm 1.400
M 2.700°K - **C** 3.000°K - **W** 4.000°K
Ø 500 mm
H 250 mm

DIMMERABILE / DIMMABLE
TAGLIO DI FASE / PHASE CUT

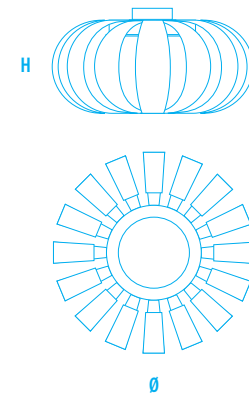

2123/PL 60

W 30 - **Vac** 230
Lm 2.300
M 2.700°K - **C** 3.000°K - **W** 4.000°K
Ø 600 mm
H 250 mm

DIMMERABILE / DIMMABLE
TAGLIO DI FASE / PHASE CUT

10
Bianco
White
/

10
Bianco
White
/

10
Bianco
White
/

19
Nero
Black
/

19
Nero
Black
/

19
Nero
Black
/

10
Bianco
White

13
Foglia Argento
Silver Leaf

14
Foglia Oro
Gold Leaf

13
Foglia Argento
Silver Leaf

14
Foglia Oro
Gold Leaf

19
Nero
Black



Eclissi

356

2140/PL100

BRAGA LED





358

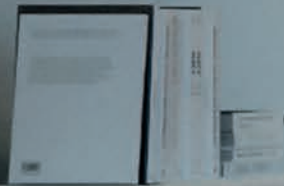

2140/A25

BRAGA LED

ECLISSI

Luce indiretta
Indirect light

CRI > 80

DIMMERABILE / DIMMABLE

Vai a pagina / Go to page 462

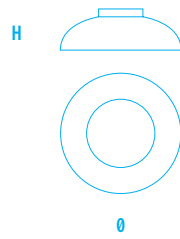

2140/PL40

W 20 - Vac 230

Lm 1.400

M 2.700°K - C 3.000°K - W 4.000°K

Ø 400 mm

H 130 mm

DIMMERABILE / DIMMABLE
TAGLIO DI FASE / PHASE CUT

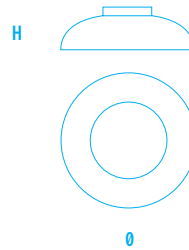

2140/PL55

W 30 - Vac 230

Lm 2.300

M 2.700°K - C 3.000°K - W 4.000°K

Ø 550 mm

H 145 mm

DIMMERABILE / DIMMABLE
TAGLIO DI FASE / PHASE CUT

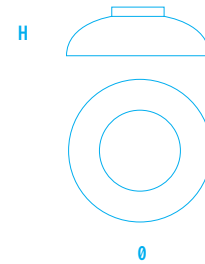

2140/PL75

W 43 - Vac 230

Lm 2.950

M 2.700°K - C 3.000°K - W 4.000°K

Ø 750 mm

H 210 mm

DIMMERABILE / DIMMABLE
TAGLIO DI FASE / PHASE CUT

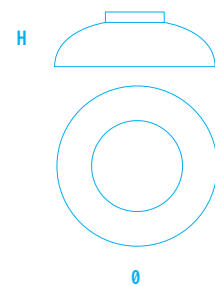

2140/PL85

W 43 - Vac 230

Lm 2.950

M 2.700°K - C 3.000°K - W 4.000°K

Ø 850 mm

H 220 mm

DIMMERABILE / DIMMABLE
TAGLIO DI FASE / PHASE CUT

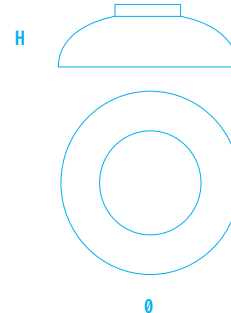

2140/PL100

W 43 - Vac 230

Lm 2.950

M 2.700°K - C 3.000°K - W 4.000°K

Ø 1.000 mm

H 250 mm

DIMMERABILE / DIMMABLE
TAGLIO DI FASE / PHASE CUT

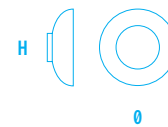

2140/A25

W 20 - Vac 230

Lm 1.400

M 2.700°K - C 3.000°K - W 4.000°K

Ø 250 mm

H 85 mm

DIMMERABILE / DIMMABLE
TAGLIO DI FASE / PHASE CUT

10

Bianco
White



19

Nero
Black



20

Corten
Corten



21

Grigio tortora
Dove grey



23

Ruggine
Rust



24

Ferro
Iron



28

Oro
Gold



34

Rosè Verniciato
Painted Rosè



35

Bronzo Verniciato
Bronze Painted



10

Bianco
White



13

Foglia Argento
Silver Leaf



14

Foglia Oro
Gold Leaf



22

Foglia rame
Coper leaf



13

Foglia Argento
Silver Leaf



14

Foglia Oro
Gold Leaf



22

Foglia rame
Coper leaf



ECLISSI

Luce indiretta
Indirect light

CRI > 80

DIMMERABILE / DIMMABLE

Vai a pagina / Go to page 462

360

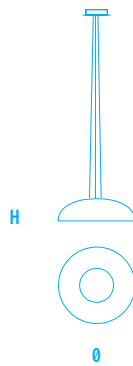

2140/S25

W 20 - Vac 230

Lm 1.400

M 2.700°K - C 3.000°K - W 4.000°K

Ø 250 mm

H 85 mm

L CAVI / CABLES 2000 mm

DIMMERABILE / DIMMABLE
TAGLIO DI FASE / PHASE CUT

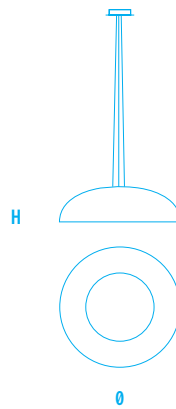

2140/S40

W 20 - Vac 230

Lm 1.400

M 2.700°K - C 3.000°K - W 4.000°K

Ø 400 mm

H 130 mm

L CAVI / CABLES 2000 mm

DIMMERABILE / DIMMABLE
TAGLIO DI FASE / PHASE CUT

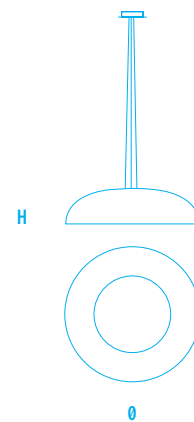

2140/S55

W 30 - Vac 230

Lm 2.300

M 2.700°K - C 3.000°K - W 4.000°K

Ø 550 mm

H 145 mm

L CAVI / CABLES 2000 mm

DIMMERABILE / DIMMABLE
TAGLIO DI FASE / PHASE CUT

10
Bianco
White



19
Nero
Black



20
Corten
Corten



21
Grigio tortora
Dove grey



23
Ruggine
Rust



24
Ferro
Iron



28
Oro
Gold



34
Rosè Verniciato
Painted Rosè



35
Bronzo Verniciato
Bronze Painted



10
Bianco
White



13
Foglia Argento
Silver Leaf



14
Foglia Oro
Gold Leaf



22
Foglia rame
Coper leaf



13
Foglia Argento
Silver Leaf



14
Foglia Oro
Gold Leaf



22
Foglia rame
Coper leaf







362

2140/S85

BRAGA LED

ECLISSI

Luce indiretta
Indirect light

CRI > 80

DIMMERABILE / DIMMABLE

Vai a pagina / Go to page 462

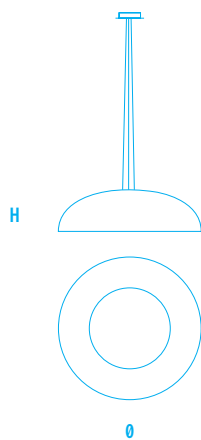

2140/S75

W 43 - Vac 230

Lm 2.950

M 2.700°K - C 3.000°K - W 4.000°K

Ø 750 mm

H 210 mm

L CAVI / CABLES 2000 mm

DIMMERABILE / DIMMABLE
TAGLIO DI FASE / PHASE CUT

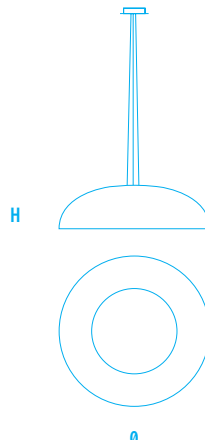

2140/S85

W 43 - Vac 230

Lm 2.950

M 2.700°K - C 3.000°K - W 4.000°K

Ø 850 mm

H 220 mm

L CAVI / CABLES 2000 mm

DIMMERABILE / DIMMABLE
TAGLIO DI FASE / PHASE CUT

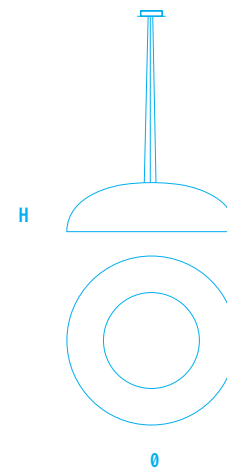

2140/S100

W 43 - Vac 230

Lm 2.950

M 2.700°K - C 3.000°K - W 4.000°K

Ø 1.000 mm

H 250 mm

L CAVI / CABLES 2000 mm

DIMMERABILE / DIMMABLE
TAGLIO DI FASE / PHASE CUT

10
Bianco
White



19
Nero
Black



20
Corten
Corten



21
Grigio tortora
Dove grey



23
Ruggine
Rust



24
Ferro
Iron



28
Oro
Gold



34
Rosè Verniciato
Painted Rosè



35
Bronzo Verniciato
Bronze Painted



10
Bianco
White



13
Foglia Argento
Silver Leaf



14
Foglia Oro
Gold Leaf



22
Foglia rame
Coper leaf



13
Foglia Argento
Silver Leaf



14
Foglia Oro
Gold Leaf



22
Foglia rame
Coper leaf





364

2149/PL55

BRAGA LED

ECLISSI

Luce diretta
Direct light

CRI > 80

DIMMERABILE / DIMMABLE

Vai a pagina / Go to page 462

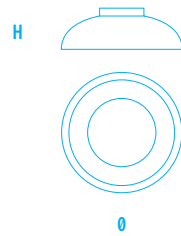

2149/PL40

W 20 - Vac 230
Lm 1.700
M 2.700°K - C 3.000°K - W 4.000°K
Ø 400 mm
H 130 mm

DIMMERABILE / DIMMABLE
TAGLIO DI FASE / PHASE CUT

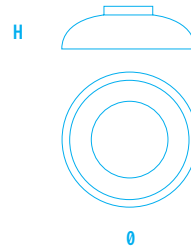

2149/PL55

W 43 - Vac 230
Lm 2.700
M 2.700°K - C 3.000°K - W 4.000°K
Ø 550 mm
H 145 mm

DIMMERABILE / DIMMABLE
TAGLIO DI FASE / PHASE CUT

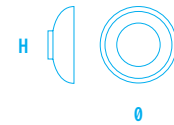

2149/A25

W 20 - Vac 230
Lm 1.700
M 2.700°K - C 3.000°K - W 4.000°K
Ø 250 mm
H 85 mm

DIMMERABILE / DIMMABLE
TAGLIO DI FASE / PHASE CUT

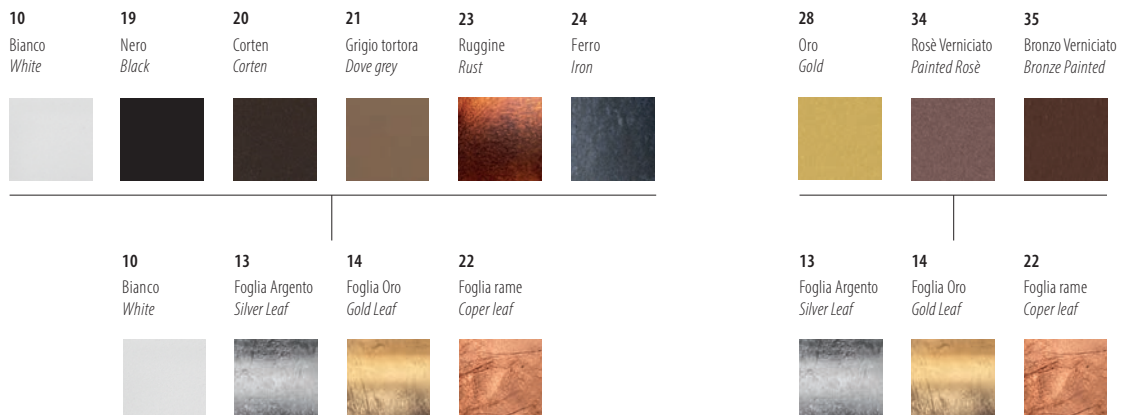

ECLISSI

Luce diretta
Direct light

CRI > 80

DIMMERABILE / DIMMABLE

Vai a pagina / Go to page 462

366

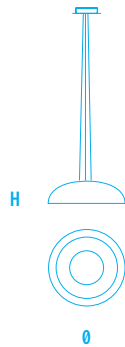

2149/S25

W 20 - Vac 230

Lm 1.700

M 2.700°K - C 3.000°K - W 4.000°K

Ø 250 mm

H 85 mm

L CAVI / CABLES 2000 mm

DIMMERABILE / DIMMABLE
TAGLIO DI FASE / PHASE CUT

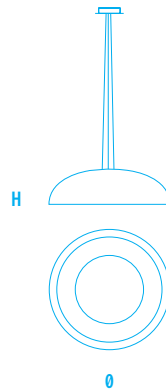

2149/S40

W 20 - Vac 230

Lm 1.700

M 2.700°K - C 3.000°K - W 4.000°K

Ø 400 mm

H 130 mm

L CAVI / CABLES 2000 mm

DIMMERABILE / DIMMABLE
TAGLIO DI FASE / PHASE CUT

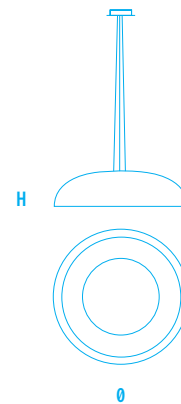

2149/S55

W 43 - Vac 230

Lm 2.700

M 2.700°K - C 3.000°K - W 4.000°K

Ø 550 mm

H 130 mm

L CAVI / CABLES 2000 mm

DIMMERABILE / DIMMABLE
TAGLIO DI FASE / PHASE CUT

10
Bianco
White



19
Nero
Black



20
Corten
Corten



21
Grigio tortora
Dove grey



23
Ruggine
Rust



24
Ferro
Iron



28
Oro
Gold



34
Rosè Verniciato
Painted Rosè



35
Bronzo Verniciato
Bronze Painted



10
Bianco
White



13
Foglia Argento
Silver Leaf



14
Foglia Oro
Gold Leaf



22
Foglia rame
Coper leaf



13
Foglia Argento
Silver Leaf



14
Foglia Oro
Gold Leaf



22
Foglia rame
Coper leaf





Greka

368

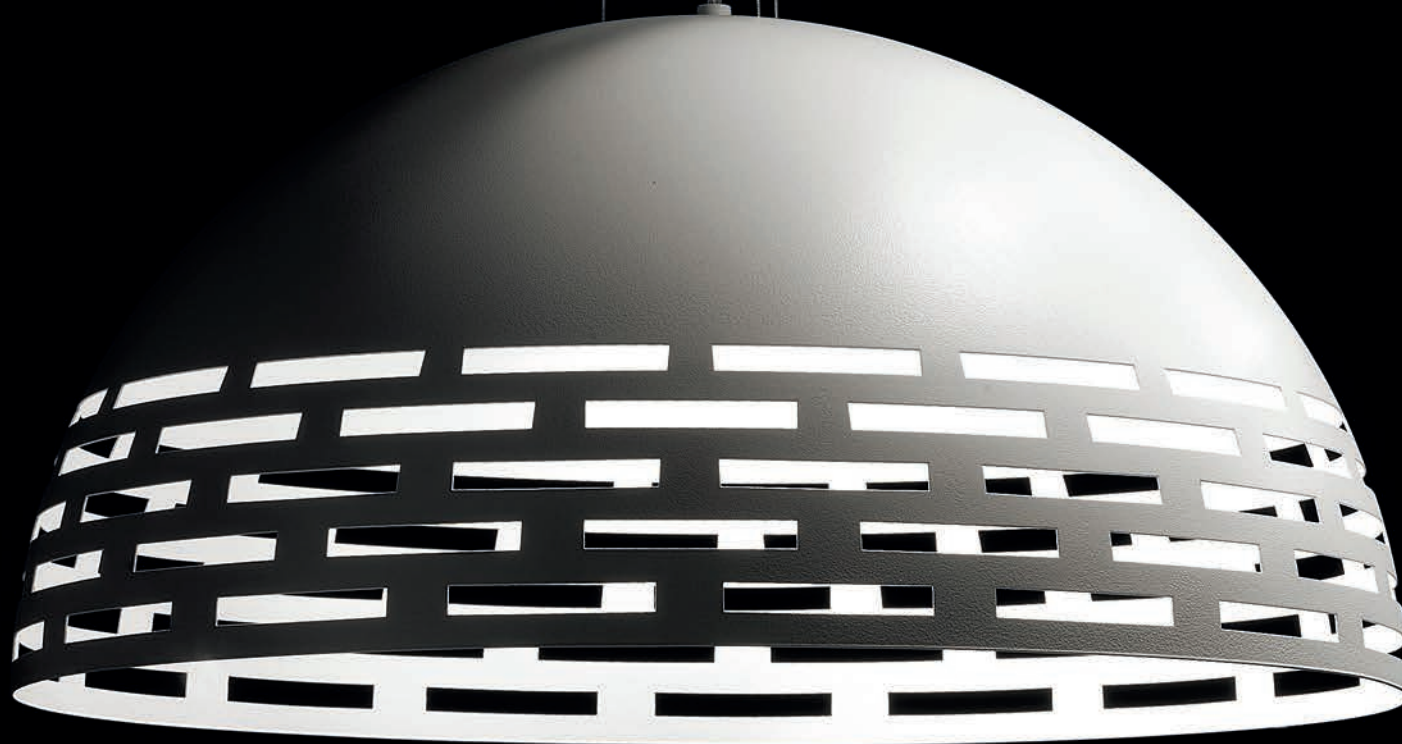



2087/S30

2087/S70

GRECA LED

370

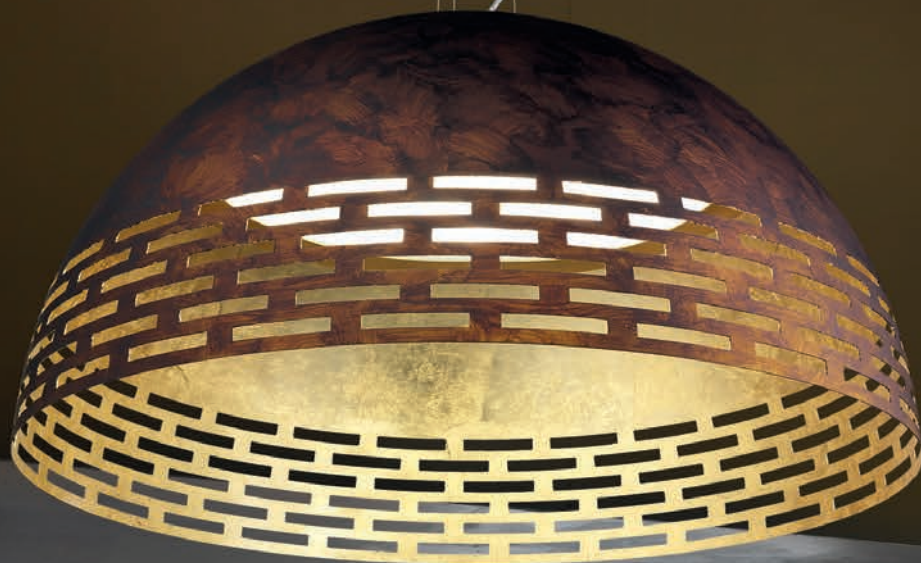

2087/S70

BRAGA LED



371

GREKA LED

CRI > 80

DIMMERABILE / DIMMABLE

Vai a pagina / Go to page 462

DIFFUSORE / DIFFUSER

Metacrilato opalino

Opal-finish methacrylate

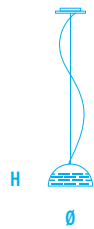

2087/S30

W 10 - Vac 230

Lm 900

M 2.700°K - C 3.000°K - W 4.000°K

Ø 300 mm

H 150 mm

L CAVI / CABLES 2.000 mm

DIMMERABILE / DIMMABLE
TAGLIO DI FASE / PHASE CUT

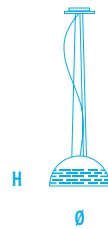

2087/S40

W 20 - Vac 230

Lm 1.400

M 2.700°K - C 3.000°K - W 4.000°K

Ø 400 mm

H 200 mm

L CAVI / CABLES 2.000 mm

DIMMERABILE / DIMMABLE
TAGLIO DI FASE / PHASE CUT

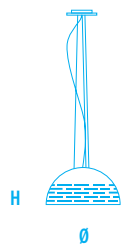

2087/S50

W 20 - Vac 230

Lm 1.400

M 2.700°K - C 3.000°K - W 4.000°K

Ø 500 mm

H 250 mm

L CAVI / CABLES 2.000 mm

DIMMERABILE / DIMMABLE
TAGLIO DI FASE / PHASE CUT

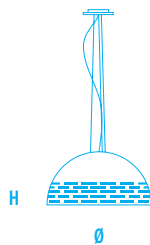

2087/S70

W 43 - Vac 230

Lm 2.900

M 2.700°K - C 3.000°K - W 4.000°K

Ø 700 mm

H 350 mm

L CAVI / CABLES 2.000 mm

DIMMERABILE / DIMMABLE
TAGLIO DI FASE / PHASE CUT

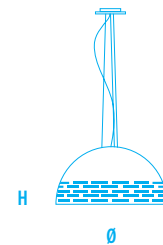

2087/S80

W 43 - Vac 230

Lm 2.900

M 2.700°K - C 3.000°K - W 4.000°K

Ø 800 mm

H 400 mm

L CAVI / CABLES 2.000 mm

DIMMERABILE / DIMMABLE
TAGLIO DI FASE / PHASE CUT

10
Bianco
White



19
Nero
Black



20
Corten
Corten



21
Grigio tortora
Dove grey



23
Ruggine
Rust



24
Ferro
Iron



28
Oro
Gold



34
Rosè Verniciato
Painted Rosè



35
Bronzo Verniciato
Bronze Painted



10
Bianco
White



13
Foglia Argento
Silver Leaf



14
Foglia Oro
Gold Leaf



22
Foglia rame
Coper leaf



13
Foglia Argento
Silver Leaf



14
Foglia Oro
Gold Leaf



22
Foglia rame
Coper leaf





374



N°2 2087/S1-9 + N°1 2087/R

BRAGA

GREKA



583/S30

1 x max 70W E27 

o/or

LED

Ø 300 mm

H 150 mm

L CAVI / CABLES 2.000 mm

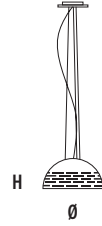

583/S40

1 x max 70W E27 

o/or

LED

Ø 400 mm

H 200 mm

L CAVI / CABLES 2.000 mm

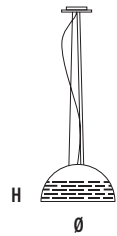

583/S50

1 x max 70W E27 

o/or

LED

Ø 500 mm

H 250 mm

L CAVI / CABLES 2.000 mm

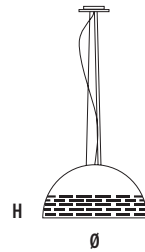

583/S70

3 x max 70W E27 

o/or

LED

Ø 700 mm

H 350 mm

L CAVI / CABLES 2.000 mm

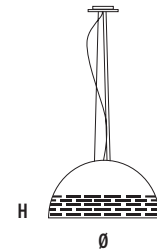

583/S80

3 x max 70W E27 

o/or

LED

Ø 800 mm

H 400 mm

L CAVI / CABLES 2.000 mm

10
Bianco
White



19
Nero
Black



20
Corten
Corten



21
Grigio tortora
Dove grey



23
Ruggine
Rust



24
Ferro
Iron



28
Oro
Gold



34
Rosè Verniciato
Painted Rosè



35
Bronzo Verniciato
Bronze Painted



10
Bianco
White



13
Foglia Argento
Silver Leaf



14
Foglia Oro
Gold Leaf



22
Foglia rame
Coper leaf



13
Foglia Argento
Silver Leaf



14
Foglia Oro
Gold Leaf



22
Foglia rame
Coper leaf



376



N°6 2087/S1-9 + N°1 2087/R6

BRAGA LED



378



N°4 2087/S1-9 + N°1 2087/R + N°4 2087/N

BRAGA LED

GREKA LED

DIMMERABILE / DIMMABLE

Vai a pagina / Go to page 462

DIFFUSORE / DIFFUSER

Metacrilato opalino

Opal-finish methacrylate



Rosone da incasso
Recessed canopy
Max 3,2 Kg

2146/R35

Ø 45 mm

H 35 mm

Ø 35 mm



2087/R6

Ø 145 mm

H 25 mm

Rosone per collegamento
da 2 a 6 2087/S1

Rose for connection from
2 to 6 2087/S1



2087/R12

Ø 170 mm

H 35 mm

Rosone per collegamento
da 2 a 12 2087/S1

Rose for connection from
2 to 12 2087/S1

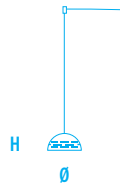

2087/S1-9

W 10 - Vac 230

Lm 900

M 2.700°K - C 3.000°K - W 4.000°K

Ø 160 mm

H 80 mm

L CAVO / CABLE 1.700 mm

DIMMERABILE / DIMMABLE
TAGLIO DI FASE / PHASE CUT



2087/N

Ø 20 mm

H 15 mm

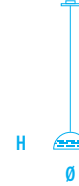

2087/S16-9

W 10 - Vac 230

Lm 900

M 2.700°K - C 3.000°K - W 4.000°K

Ø 160 mm

H 80 mm

L CAVO / CABLE 1.700 mm

DIMMERABILE / DIMMABLE
TAGLIO DI FASE / PHASE CUT

10
Bianco
White



19
Nero
Black



20
Corten
Corten



21
Grigio tortora
Dove grey



23
Ruggine
Rust



24
Ferro
Iron



28
Oro
Gold



34
Rosè Verniciato
Painted Rosè



35
Bronzo Verniciato
Bronze Painted



10
Bianco
White



13
Foglia Argento
Silver Leaf



14
Foglia Oro
Gold Leaf



22
Foglia rame
Coper leaf



13
Foglia Argento
Silver Leaf



14
Foglia Oro
Gold Leaf



22
Foglia rame
Coper leaf



380



2087/A

BRAGA LED

GREKA LED

CRI > 80

DIFFUSORE / DIFFUSER

Metacrilato opalino

Opal-finish methacrylate



381



L



SP

2087/A

W 17 - Vac 230

Lm 1.800

M 2.700°K - C 3.000°K - W 4.000°K

L 300 x 150 mm

SP 150 mm

DIMMERABILE / DIMMABLE
TAGLIO DI FASE / PHASE CUT

Vai a pagina / Go to page 462

2087/A

| | | | | | | | | |
|-----------------------|-------------------------------------|-------------------------------|-----------------------------------|-------------------------------------|-------------------------------|---------------------------------|---------------------------------------|---|
| 10 Bianco White | 19 Nero Black | 20 Corten Corten | 21 Grigio tortora Dove grey | 23 Ruggine Rust | 24 Ferro Iron | 28 Oro Gold | 34 Rosè Verniciato Painted Rosè | 35 Bronzo Verniciato Bronze Painted |
| | | | | | | | | |
| 10 Bianco White | 13 Foglia Argento Silver Leaf | 14 Foglia Oro Gold Leaf | 22 Foglia rame Coper leaf | 13 Foglia Argento Silver Leaf | 14 Foglia Oro Gold Leaf | 22 Foglia rame Coper leaf | | |
| | | | | | | | | |

Dune

382



561/S50

BRAGA



384

561/S40

BRAGA



DUNE LED

CRI > 80

DIMMERABILE / DIMMABLE

Vai a pagina / Go to page 462

DIFFUSORE / DIFFUSER

Metacrilato opalino

Opal-finish methacrylate



2100/S30

W 10 - Vac 230

Lm 900

M 2.700°K - C 3.000°K - W 4.000°K

Ø 300 mm

H 150 mm

L CAVI / CABLES 2.000 mm

DIMMERABILE / DIMMABLE
TAGLIO DI FASE / PHASE CUT

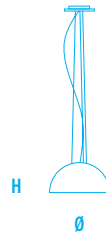

2100/S40

W 20 - Vac 230

Lm 1.400

M 2.700°K - C 3.000°K - W 4.000°K

Ø 400 mm

H 200 mm

L CAVI / CABLES 2.000 mm

DIMMERABILE / DIMMABLE
TAGLIO DI FASE / PHASE CUT

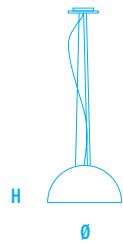

2100/S50

W 20 - Vac 230

Lm 1.400

M 2.700°K - C 3.000°K - W 4.000°K

Ø 500 mm

H 250 mm

L CAVI / CABLES 2.000 mm

DIMMERABILE / DIMMABLE
TAGLIO DI FASE / PHASE CUT

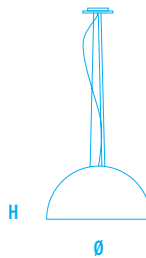

2100/S70

W 43 - Vac 230

Lm 2.900

M 2.700°K - C 3.000°K - W 4.000°K

Ø 700 mm

H 350 mm

L CAVI / CABLES 2.000 mm

DIMMERABILE / DIMMABLE
TAGLIO DI FASE / PHASE CUT

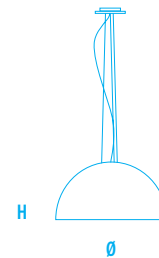

2100/S80

W 43 - Vac 230

Lm 2.900

M 2.700°K - C 3.000°K - W 4.000°K

Ø 800 mm

H 400 mm

L CAVI / CABLES 2.000 mm

DIMMERABILE / DIMMABLE
TAGLIO DI FASE / PHASE CUT

10
Bianco
White



19
Nero
Black



20
Corten
Corten



21
Grigio tortora
Dove grey



23
Ruggine
Rust



24
Ferro
Iron



28
Oro
Gold



34
Rosè Verniciato
Painted Rosè



35
Bronzo Verniciato
Bronze Painted



10
Bianco
White



13
Foglia Argento
Silver Leaf



14
Foglia Oro
Gold Leaf



22
Foglia rame
Coper leaf



13
Foglia Argento
Silver Leaf



14
Foglia Oro
Gold Leaf



22
Foglia rame
Coper leaf





386

561/S70

BRAGA



DUNE

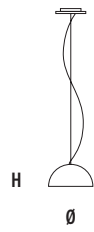

561/S30

1 x max 70W E27 

o/or
LED

Ø 300 mm

H 150 mm

L CAVI / CABLES 2.000 mm

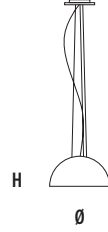

561/S40

1 x max 70W E27 

o/or
LED

Ø 400 mm

H 200 mm

L CAVI / CABLES 2.000 mm

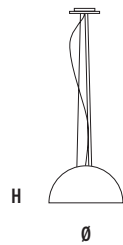

561/S50

1 x max 70W E27 

o/or
LED

Ø 500 mm

H 250 mm

L CAVI / CABLES 2.000 mm

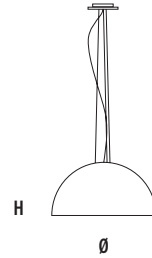

561/S70

3 x max 70W E27 

o/or
LED

Ø 700 mm

H 350 mm

L CAVI / CABLES 2.000 mm

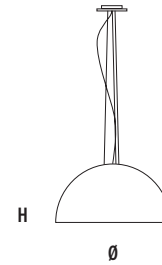

561/S80

3 x max 70W E27 

o/or
LED

Ø 800 mm

H 400 mm

L CAVI / CABLES 2.000 mm

10
Bianco
White



19
Nero
Black



20
Corten
Corten



21
Grigio tortora
Dove grey



23
Ruggine
Rust



24
Ferro
Iron



28
Oro
Gold



34
Rosè Verniciato
Painted Rosè



35
Bronzo Verniciato
Bronze Painted



10
Bianco
White



13
Foglia Argento
Silver Leaf



14
Foglia Oro
Gold Leaf



22
Foglia rame
Coper leaf



13
Foglia Argento
Silver Leaf



14
Foglia Oro
Gold Leaf



22
Foglia rame
Coper leaf





389

DUNE

561/S50

Sfera

390



2108/PL4

BRAGA LED







394

2108/A

BRAGA LED



SFERA

DIFFUSORE / DIFFUSER

Vetro satinato

Satin-finish glass

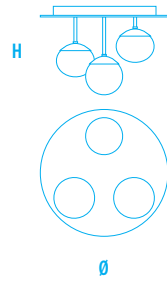

2108/PL3

3 x MAX W 28 - G 9

O/OR LED

Ø 460 mm

H 360 mm

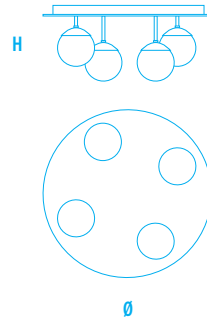

2108/PL4

4 x MAX W 28 - G 9

O/OR LED

Ø 580 mm

H 300 mm

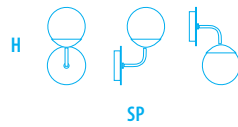

2108/A

1 x MAX W 28 - G 9

O/OR LED

Ø 180 mm

H 290 mm

SP 170 mm



2108/L

1 x MAX W 28 - G 9

O/OR LED

Ø 140 mm

H 260 mm

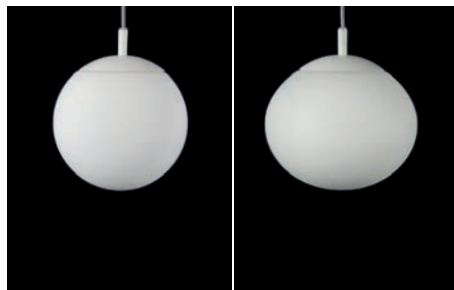

V1

Ø 140 mm

V2

Ø 160 mm

H 130 mm

10

Bianco
White



13

Foglia Argento
Silver Leaf



14

Foglia Oro
Gold Leaf



20

Corten
Corten



21

Grigio tortora
Dove grey



22

Foglia rame
Copper leaf



27

Ossidato
Oxydized



SFERA

DIFFUSORE / DIFFUSER

Vetro satinato

Satin-finish glass

396

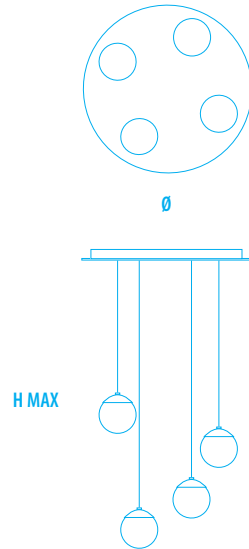

2108/54

4 x MAX W 28 - G 9

O/OR LED

Ø 580 mm

H MAX 1000 mm

DIMMERABILE / DIMMABLE

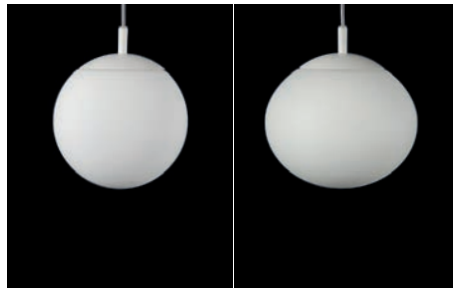

V1

Ø 140 mm

V2

Ø 160 mm

H 130 mm

10
Bianco
White



13
Foglia Argento
Silver Leaf



14
Foglia Oro
Gold Leaf



20
Corten
Corten



21
Grigio tortora
Dove grey



22
Foglia rame
Copper leaf



27
Ossidato
Oxydized





SFERA

DIFFUSORE / DIFFUSER

Vetro satinato

Satin-finish glass



Ø

Rosone da incasso

Recessed canopy

Max 3,2 Kg

2146/R35

Ø 45 mm

H 35 mm



Ø 35 mm



Ø

2108/R6

Ø 145 mm

H 25 mm

Rosone per collegamento
da 2 a 6 2108/SM

Rose for connection from
2 to 6 2108/SM



Ø

2108/R12

Ø 175 mm

H 35 mm

Rosone per collegamento
da 2 a 12 2108/SM

Rose for connection from
2 to 12 2108/SM



Ø

2108/N

Ø 20 mm

H 15 mm

398

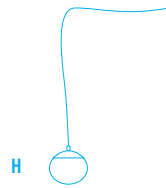

Ø

2108/SM

1 x MAX W 28 - G 9

O/OR LED

H 160 mm

L CAVO / CABLES 1.700 mm

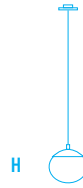

Ø

2108/S1

1 x MAX W 28 - G 9

O/OR LED

H 160 mm

L CAVO / CABLES 1.700 mm

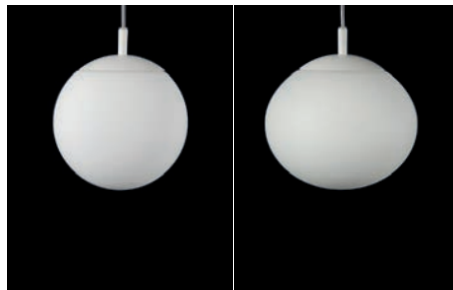

V1

Ø 140 mm

V2

Ø 160 mm

H 130 mm

10

Bianco
White



13

Foglia Argento
Silver Leaf



14

Foglia Oro
Gold Leaf



20

Corten
Corten



21

Grigio tortora
Dove grey



22

Foglia rame
Copper leaf



27

Ossidato
Oxydized





Tile

400



2121/S2

BRAGA LED



401

TILE

2121/T



402

TILE

CRI > 80

DIFFUSORE / DIFFUSER

Metacrilato opalino
Opaline-finish methacrylate

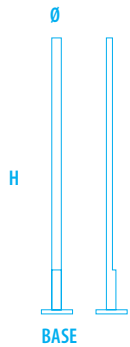

2121/T

W 35 - Vac 230
Lm 2.500
M 2.700°K - C 3.000°K - W 4.000°K

H 1.950 x Ø 70 mm
BASE Ø 240 mm
TOUCH DIMMER

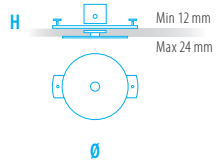

Rosone da incasso
Recessed canopy
Max 3,2 Kg

2146/R35

Ø 45 mm
H 35 mm
Ø 35 mm



Alimentatore Remoto
Remote Power Supply

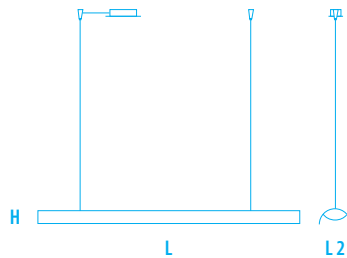

2121/S1

W 24 - Vac 230
Lm 1.700
M 2.700°K - C 3.000°K - W 4.000°K

L 1.250 x L2 70 mm
H 35 mm
L CAVI / CABLES 1.700 mm
TOUCH DIMMER

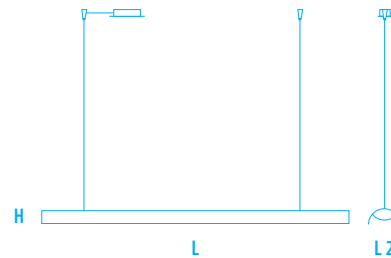

2121/S2

W 33 - Vac 230
Lm 2.350
M 2.700°K - C 3.000°K - W 4.000°K

L 1.600 x L2 70 mm
H 35 mm
L CAVI / CABLES 1.700 mm
TOUCH DIMMER

| | | | | | | |
|-----------------------|---------------------|------------------------|-------------------------------------|-------------------------------|---------------------------------|----------------------------|
| 10 Bianco White | 19 Nero Black | 20 Corten Corten | 21 Grigio tortora Dove grey | 23 Ruggine Rust | 24 Ferro Iron | 27 Ossidato Oxydized |
| | | | | | | |
| | | | 13 Foglia Argento Silver Leaf | 14 Foglia Oro Gold Leaf | 22 Foglia rame Coper leaf | |
| | | | | | | |

Lithos

404

2112/T

BRAGA LED





406



2112/T

BRAGALED

LITHOS

CRI > 80

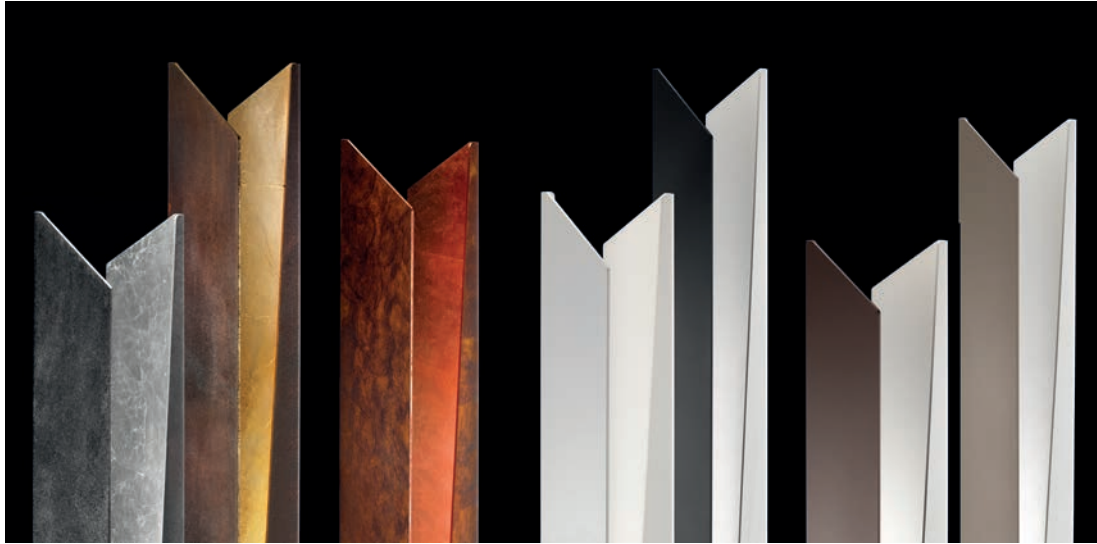

407



BASE

2112/T

W 30 - Vac 230

Lm 2.300

M 2.700°K - C 3.000°K

H 1930 x L 150 x 150 mm

BASE 230 x 230 mm

CON DIMMER / WITH DIMMER

| | | | | | | |
|-----------------------|-------------------------------------|-------------------------------|-----------------------------------|-----------------------|---------------------|----------------------------|
| 10 Bianco White | 19 Nero Black | 20 Corten Corten | 21 Grigio tortora Dove grey | 23 Ruggine Rust | 24 Ferro Iron | 27 Ossidato Oxydized |
| | | | | | | |
| 10 Bianco White | 13 Foglia Argento Silver Leaf | 14 Foglia Oro Gold Leaf | 22 Foglia rame Coper leaf | | | |
| | | | | | | |

Truciolo

408



2083/T

BRAGA LED



410





412

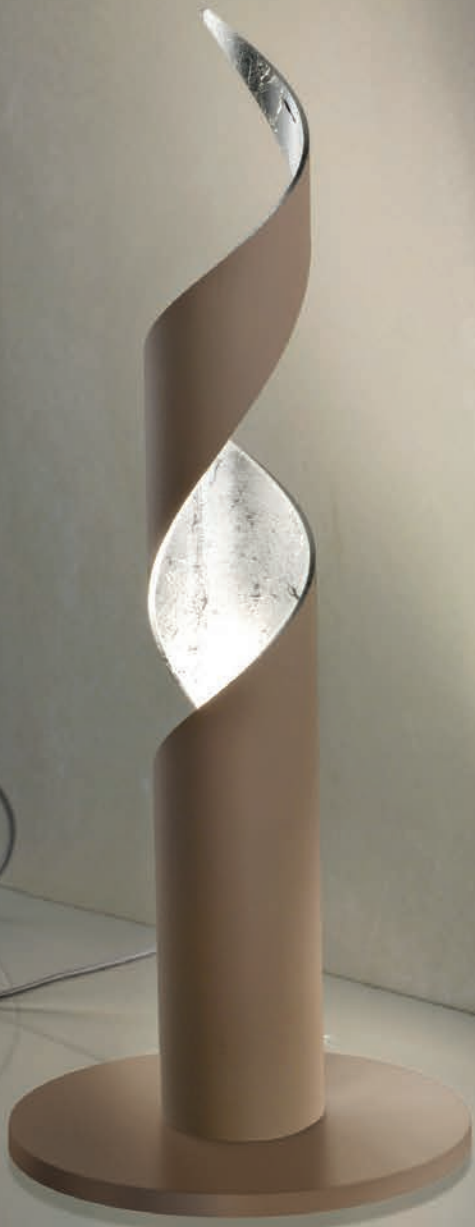

2083/L



BRAGA

TRUCIOLO

CRI > 80



2083/T

1 x E27 **PAR 38** LED
DIMMERABILE / DIMMABLE

H 2000 x Ø 150 mm
BASE 240 x 240 mm

CON DIMMER / WITH DIMMER



2084/T

W 30 - **Vac** 230

Lm 2.200
M 2.700°K - **C** 3.000°K

H 2000 x Ø 150 mm
BASE 240 x 240 mm

CON DIMMER / WITH DIMMER

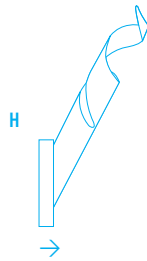

2083/A

W 8 - **Vac** 230

Lm 600
M 2.700°K - **C** 3.000°K

H 390 mm
 → 230 mm

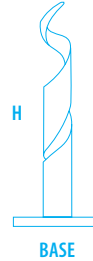

2083/L

W 4 - **Vac** 230

Lm 300
M 2.700°K - **C** 3.000°K

H 370 mm
BASE 150 x 150 mm

10

Bianco
 White



19

Nero
 Black



21

Grigio tortora
 Dove grey



23

Ruggine
 Rust



24

Ferro
 Iron



13

Foglia Argento
 Silver Leaf



14

Foglia Oro
 Gold Leaf



22

Foglia rame
 Copper leaf





2084/L70

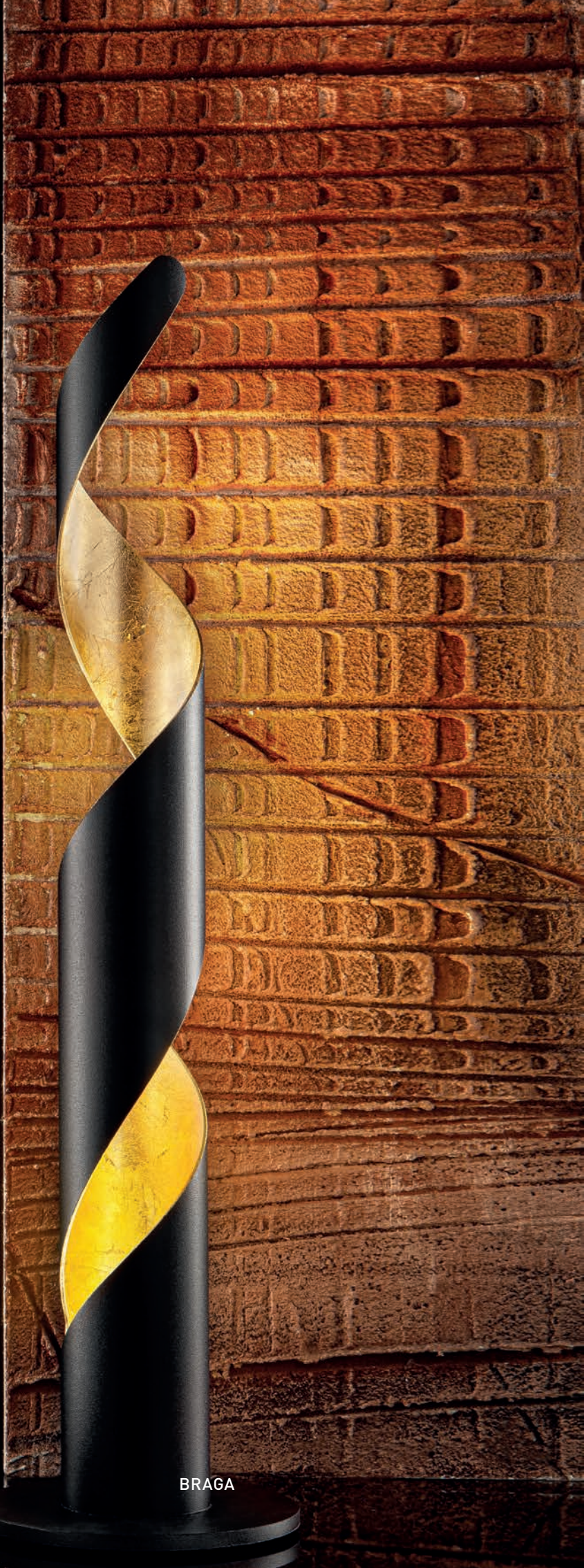

BRAGA

TRUCIOLO

CRI > 80

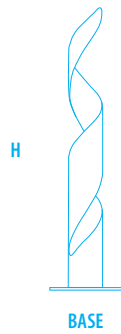

2084/L70

W 10 - Vac 230

Lm 700

M 2.700°K - C 3.000°K

H 700 x Ø 80 mm

BASE Ø 180 mm

10

Bianco
White



19

Nero
Black



21

Grigio tortora
Dove grey



23

Ruggine
Rust



24

Ferro
Iron



13

Foglia Argento
Silver Leaf



14

Foglia Oro
Gold Leaf



22

Foglia rame
Coper leaf



Reed

416



BRAGA LED

2096/T

REED

CRI > 80



BASE

2096/T

W 30 - Vac 230

Lm 2.200

M 2.700°K - C 3.000°K

L 2000 x Ø 150 mm

BASE 240 x 240 mm

CON DIMMER / WITH DIMMER



417

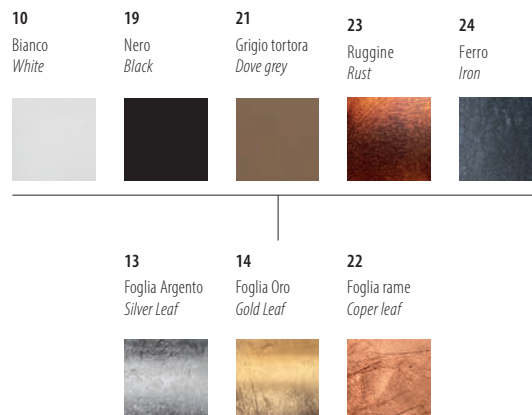

Cannula

418



2102/T

BRAGA



420



2102/T



BRAGA

CANNULA



421



2102/T

1 x E27 PAR 38 LED
DIMMERABILE / DIMMABLE

H 1980 x Ø 150 mm
BASE 240 x 240 mm

CON DIMMER / WITH DIMMER



2103/T

W 30 - Vac 230

Lm 2.200
M 2.700°K - C 3.000°K

H 1980 x Ø 150 mm
BASE 240 x 240 mm

CON DIMMER / WITH DIMMER

CRI > 80

10

Bianco
White



19

Nero
Black



21

Grigio tortora
Dove grey



23

Ruggine
Rust



24

Ferro
Iron



13

Foglia Argento
Silver Leaf



14

Foglia Oro
Gold Leaf



22

Foglia rame
Coper leaf



Volta



422



2010/A60

BRAGA LED



423

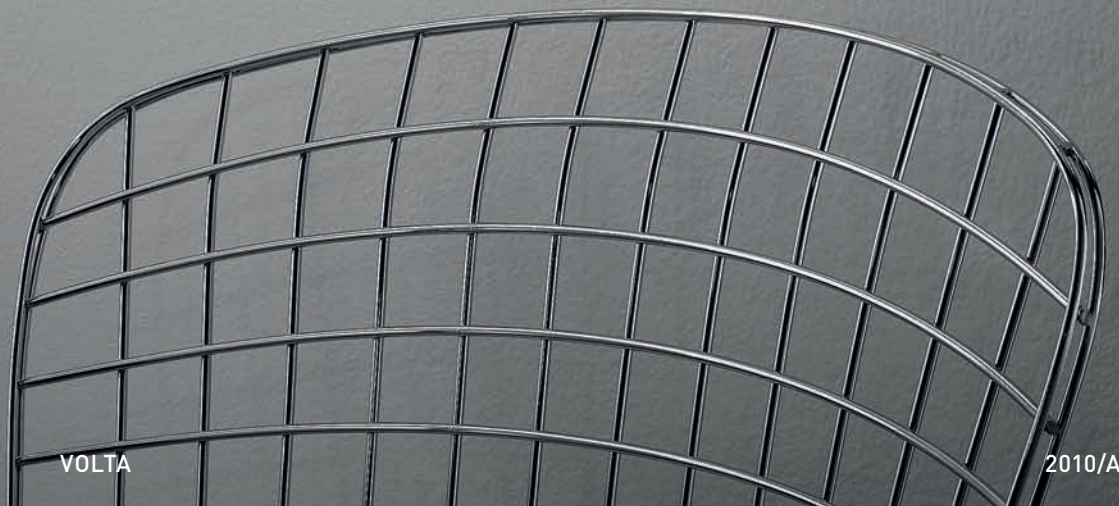

VOLTA

2010/A40



424

2010/A

BRAGA LED



CRI > 80

DIMMERABILE / DIMMABLE

Vai a pagina / Go to page 462

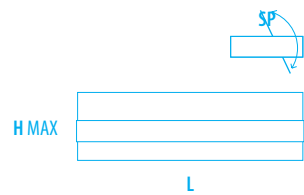

2010/A60

W 48 - **Vac** 230
Lm 3.600
M 2.700°K - **C** 3.000°K - **W** 4.000°K
L 600 x **H** 55 x **SP** 140 mm
H MAX 120 mm

DIMMERABILE / DIMMABLE
 TAGLIO DI FASE / PHASE CUT

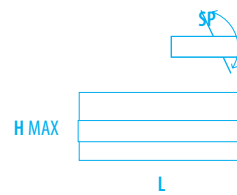

2010/A40

W 32 - **Vac** 230
Lm 2.400
M 2.700°K - **C** 3.000°K - **W** 4.000°K
L 380 x **H** 55 x **SP** 140 mm
H MAX 120 mm

DIMMERABILE / DIMMABLE
 TAGLIO DI FASE / PHASE CUT

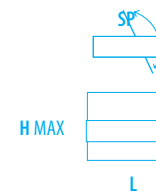

2010/A

W 16 - **Vac** 230
Lm 1.200
M 2.700°K - **C** 3.000°K - **W** 4.000°K
L 160 x **H** 50 x **SP** 170 mm
H MAX 130 mm

DIMMERABILE / DIMMABLE
 TAGLIO DI FASE / PHASE CUT

10
 Bianco
 White



11
 Cromo
 Chrome



13
 Foglia Argento
 Silver Leaf



14
 Foglia Oro
 Gold Leaf



15
 Grigio
 Grey



19
 Nero
 Black



21
 Grigio tortora
 Dove grey



Cubo

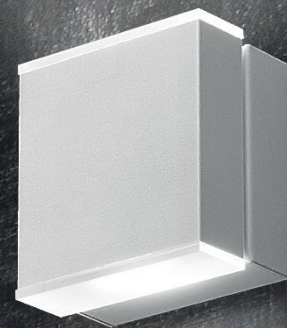
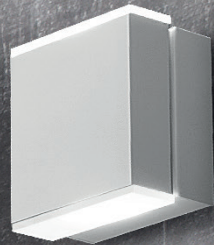

426



2036/A

BRAGA LED



428



2036/A1

BRAGA LED

CUBO

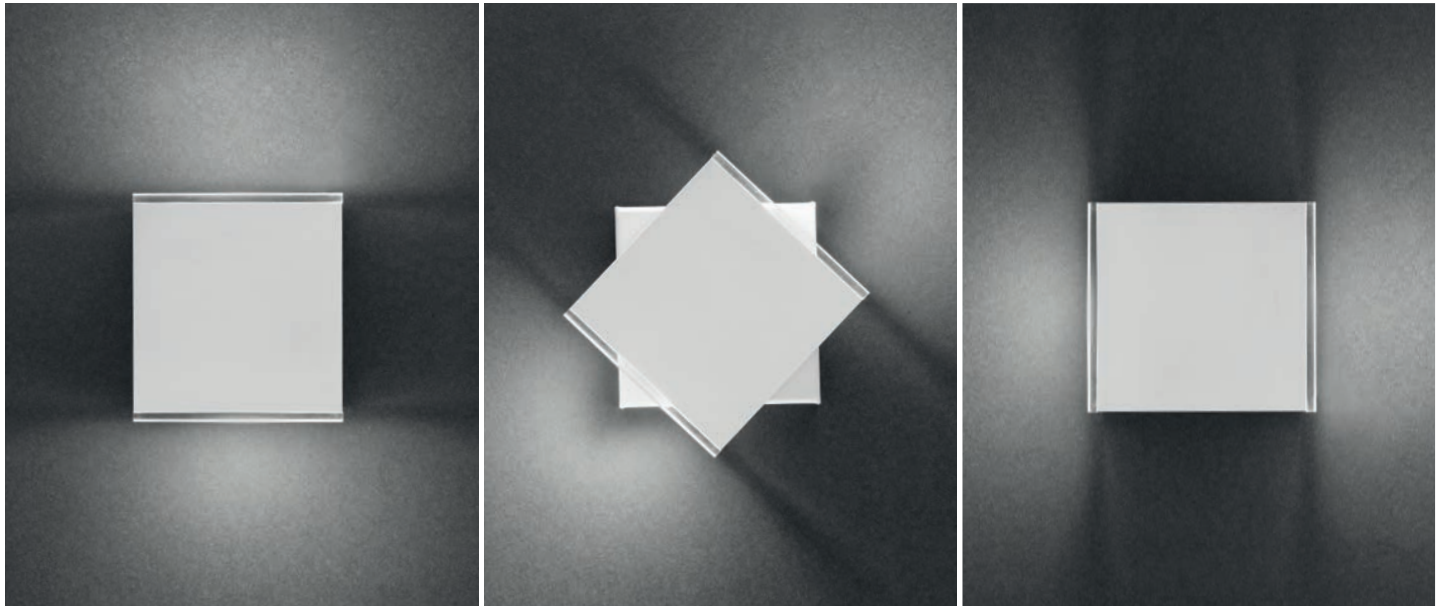

429

CRI > 80

DIFFUSORE / DIFFUSER

Vetro satinato
Satin-finish glass

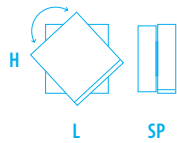

2036/A1

W 7,5 - Vac 230

Lm 500 - C 3.000°K

L 100 x 100 - SP 65 mm

DIMMERABILE / DIMMABLE

2036/A1-D4 Taglio di fase / Phase cut

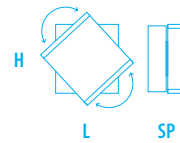

2036/A

W 15 - Vac 230

Lm 1.000 - C 3.000°K

L 100 x 100 - SP 65 mm

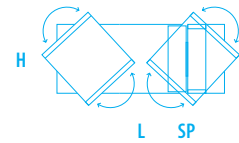

2036/A2

W 30 - Vac 230

Lm 2.000 - C 3.000°K

L 270 - SP 70 mm

H 110 mm

10
Bianco
White



13
Foglia Argento
Silver Leaf



14
Foglia Oro
Gold Leaf



10
Bianco
White



11
Cromo
Chrome



13
Foglia Argento
Silver Leaf



14
Foglia Oro
Gold Leaf



Glass LED

430

2081/PL40

BRAGA LED



GLASS LED

CRI > 80

DIMMERABILE / DIMMABLE

Vai a pagina / Go to page 462

DIFFUSORE / DIFFUSER

Vetro bianco / White glass

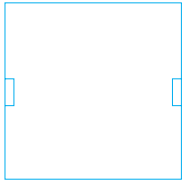

L

2081/PL60

W 43 - Vac 230

Lm 2.900

M 2.700°K - C 3.000°K - W 4.000°K

L 600 x 600 mm

SP 60 mm

DIMMERABILE / DIMMABLE
TAGLIO DI FASE / PHASE CUT



431

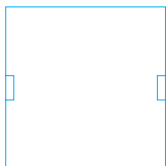

L

2081/PL50

W 30 - Vac 230

Lm 2.300

M 2.700°K - C 3.000°K - W 4.000°K

L 500 x 500 mm

SP 55 mm

DIMMERABILE / DIMMABLE
TAGLIO DI FASE / PHASE CUT

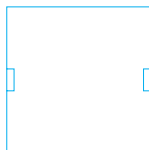

L

2081/PL40

W 20 - Vac 230

Lm 1.400

M 2.700°K - C 3.000°K - W 4.000°K

L 400 x 400 mm

SP 55 mm

DIMMERABILE / DIMMABLE
TAGLIO DI FASE / PHASE CUT

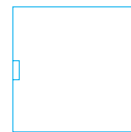

L

2081/PL30

W 17 - Vac 230

Lm 1.200

M 2.700°K - C 3.000°K - W 4.000°K

L 300 x 300 mm

SP 50 mm

DIMMERABILE / DIMMABLE
TAGLIO DI FASE / PHASE CUT

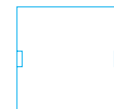

L

2081/PL20

W 10 - Vac 230

Lm 900

M 2.700°K - C 3.000°K - W 4.000°K

L 230 x 230 mm

SP 35 mm

DIMMERABILE / DIMMABLE
TAGLIO DI FASE / PHASE CUT

12

Nickel
Nickel



Virgola

432



582/A

BRAGA



VIRGOLA



433

582/A-V

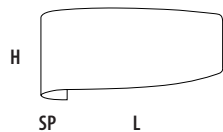

582/A

1 x max 70W E27 
o/or
LED

L 350 x H 150 mm
SP 100 mm

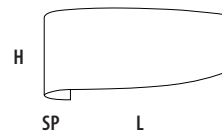

582/A-V

1 x max 70W E27 
o/or
LED

L 350 x H 150 mm
SP 100 mm

10
Bianco
White



13
Foglia Argento
Silver Leaf



14
Foglia Oro
Gold Leaf



20
Corten
Corten



21
Grigio tortora
Dove grey



22
Foglia rame
Copper leaf finish



582/A-V-S
Vetro Satinato
Satin-finish glass



582/A-V-L
Vetro Lucido
Polished glass



Edison

434



2113/SM

BRAGA LED



435

EDISON

2113/S1

436



2113/SM

BRAGA LED



EDISON

438

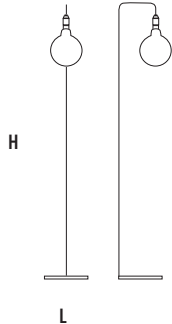

2113/T

1 x max 70W E27 

o/or

LED

H 1.820 mm

BASE Ø 320 mm

B

Bianco
White



N

Nero
Black





EDISON

2113/T



440

2113/S1

BRAGA LED

EDISON

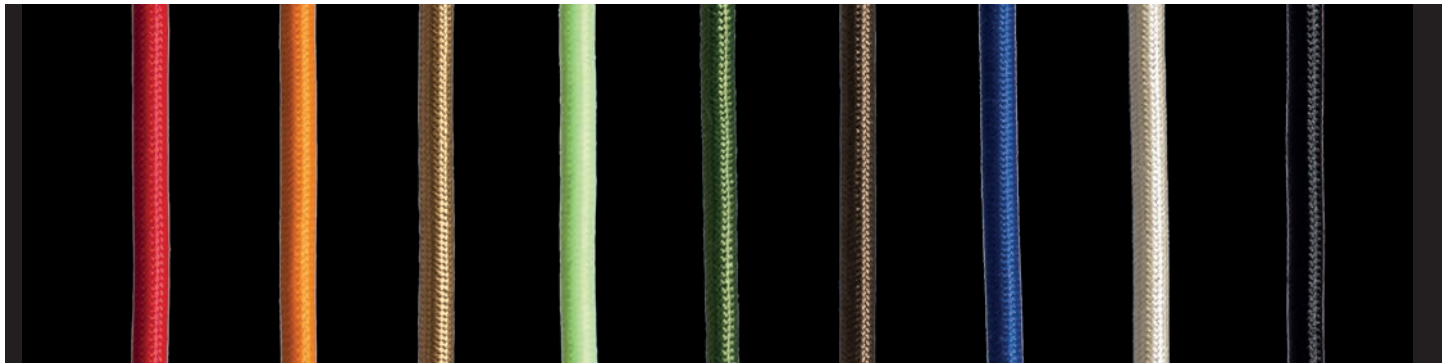

Rosso / Red
90

Arancio / Orange
91

Oro / Gold
92

Giallo / Yellow
93

Cipresso / Cypress
94

Moka / Moka
95

Zaffiro / Sapphire
96

Avorio / Ivory
97

Nero / Black
98

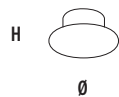

2113/R6

Ø 140 mm
H 25 mm

Rosone per collegamento
da 2 a 6 2113/SM

*Rose for connection from
2 to 6 2113/SM*

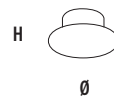

2113/R12

Ø 175 mm
H 35 mm

Rosone per collegamento
da 2 a 12 2113/SM

*Rose for connection from
2 to 12 2113/SM*



2113/N

Ø 20 mm
H 15 mm

ESEMPIO D'ORDINE / EXAPLE OF ORDER

ART. 2113/S1 90 B

90 = Colore cavo Cable color: Rosso Red

B = Colore componenti Components Colour: Bianco White

ART. 2113/S1 90 N

90 = Colore cavo Cable color: Rosso Red

N = Colore componenti Components Colour: Nero Black



Ø

2113/S1

1 x max 70W E27
o/or
LED

Ø 125 mm
L CAVO / CABLE 2.000 mm

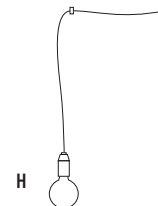

Ø

2113/SM

1 x max 70W E27
o/or
LED

Ø 125 mm
L CAVO / CABLE 2.000 mm

B
Bianco
White



N
Nero
Black



Keplero 24 V

442



KEPLERO 24 V

CRI > 80

DIFFUSORE / DIFFUSER

Metacrilato satinato
Satin-finish methacrylate

INTERASSE CAVI 105 mm

GAP BETWEEN CABLES 105 mm

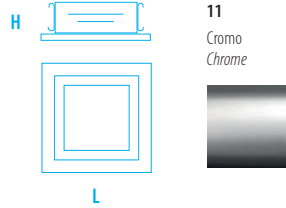

2023

W 8 - Vdc 24

Lm 800

C 3.000°K - W 4.000°K

L 120 x 120 mm

H 40 mm

KEPLERO ACCESSORI 24 V

443



2022/M

Kit 2 morsetti per connessione cavo - trasformatore

2 terminals for wire - transformer connection

Ø 6 mm

11

Cromo
Chrome



2022/C10 · 2022/C50

10 metri di CAVO NON ISOLATO
50 metri di CAVO NON ISOLATO

10 metres of NON-INSULATED WIR
50 metres of NON-INSULATED WIR

Ø 6 mm

12

Nickel
Nickel



2022/TR 24

Trasformatore 150 W
in 230 VAC-OUT 24 VDC

L 245 X 130 mm

H 45 mm

DIMMERABILE / DIMMABLE

2022/TR24-D4

Taglio di fase / Phase Cut

2022/TR24-D6

1-10V - DALI - PUSH

10

Bianco
White

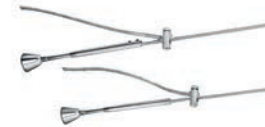

2022/P

Kit fissaggio parete - parete
Wall-wall fixing kit

15

Grigio
Grey

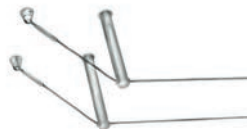

2022/D-5

Kit deviazione a soffitto
Ceiling extension kit

Ø 20 mm

H 160 mm

11

Cromo
Chrome



2022/ASC

Kit ausiliario sospensione cavo
per lunghe testate

Support kit for extra-long
wire systems

L 140 mm

H MAX 1.300 mm

Polycarbonato trasparente
Transparent polycarbonate



Bit 24 V

444

2075/1-37

2075/2-37

BRAGA LED

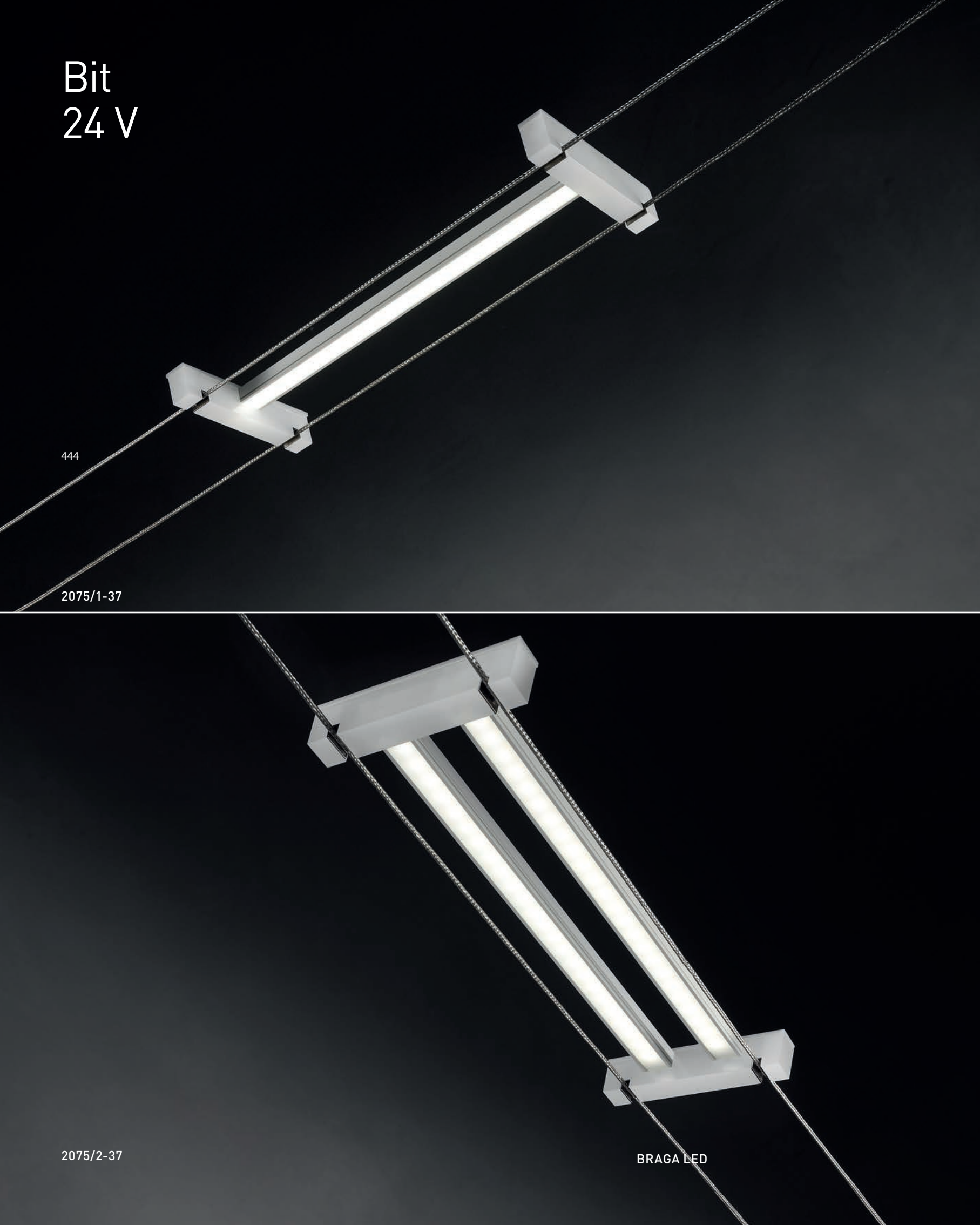

BIT 24 V

CRI > 80

DIFFUSORE / DIFFUSER

Metacrilato satinato
Satin-finish methacrylate

INTERASSE CAVI 105 mm
GAP BETWEEN CABLES 105 mm



2075/1-37

W 7 - Vdc 24

Lm 500

C 3.000°K - W 4.000°K

L 370 x 140 mm

H 25 mm



2075/2-37

W 14 - Vdc 24

Lm 1.000

C 3.000°K - W 4.000°K

L 370 x 140 mm

H 25 mm



2075/1-75

W 13 - Vdc 24

Lm 950

C 3.000°K - W 4.000°K

L 750 x 140 mm

H 25 mm



2075/2-75

W 26 - Vdc 24

Lm 1.900

C 3.000°K - W 4.000°K

L 750 x 140 mm

H 25 mm

10

Bianco
White



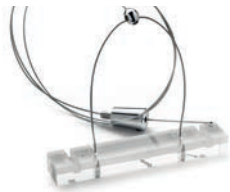

2022/ASC

Kit ausiliario sospensione cavo per lunghe tesate

Support kit for extra-long wire systems

L 140 mm
H MAX 1.300 mm

Policarbonato trasparente
Transparent polycarbonate



2022/C10 · 2022/C50

10 metri di CAVO NON ISOLATO
50 metri di CAVO NON ISOLATO

10 metres of NON-INSULATED WIR
50 metres of NON-INSULATED WIR

Ø 6 mm

12

Nickel
Nickel



2022/M

Kit 2 morsetti per connessione cavo - trasformatore

2 terminals for wire - transformer connection

Ø 6 mm

11

Cromo
Chrome



446



2022/P

Kit fissaggio parete - parete
Wall-wall fixing kit

15

Grigio
Grey



2022/D-S

Kit deviazione a soffitto
Ceiling extension kit

Ø 20 mm
H 160 mm

11

Cromo
Chrome



2022/TR 24

Trasformatore 150 W
in 230 VAC-OUT 24 VDC

L 245 X 130 mm
H 45 mm

DIMMERABILE / DIMMABLE

2022/TR24-D4

Taglio di fase / Phase Cut

2022/TR24-D6
1-10V - DALI - PUSH

10

Bianco
White





447

2075/1-75



BIT 24 V

2075/2-75

Orione

448

2000

BRAGA LED



ORIONE

CRI > 80

DIFFUSORE / DIFFUSER

Vetro satinato / *Satin-finish glass*



449

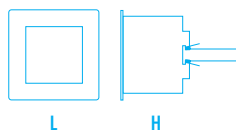

2000

1 x max 50 W GU10 

o/or

LED

Vac 230

L 90 x 90 mm

H 80 mm



FORO 80 x 70 mm

10

Bianco
White



11

Cromo
Chrome



12

Nickel
Nickel



Rosoni / Canopy

PER ARTICOLI / FOR ARTICLES 2087/S1-9 - 2094/SM - 2108/SM - 2113/SM



2147/150

L 1.500
L2 30 mm
H 47 mm

Numero di fori per sospensioni su richiesta / Number of holes for pendants on request

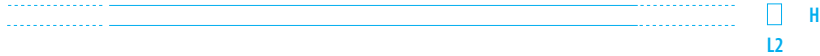

2147/50

L 500 mm
L2 30 mm
H 47 mm

2147/100

L 1.000 mm
L2 30 mm
H 47 mm

2147/200

L 2.000 mm
L2 30 mm
H 47 mm

2147/250

L 2.500 mm
L2 30 mm
H 47 mm

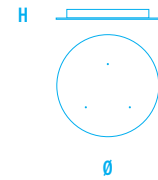

2146/PL30

Ø 300 mm
H 37 mm

450

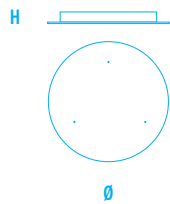

2146/PL3

Ø 440 mm
H 60 mm

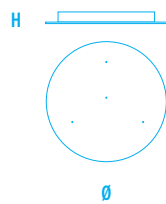

2146/PL4

Ø 440 mm
H 60 mm

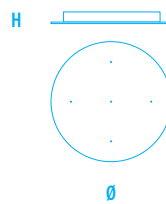

2146/PL5

Ø 440 mm
H 60 mm

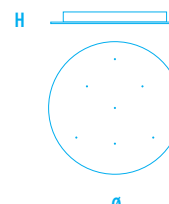

2146/PL7

Ø 560 mm
H 60 mm

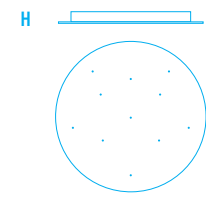

2146/PL11

Ø 700 mm
H 60 mm



2146/N

Ø 20 mm
H 15 mm

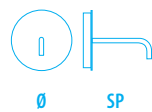

2146/A

Ø 120 mm
SP 150 mm

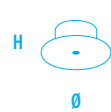

2146/R1

Ø 105 mm
H 30 mm



2146/R6

Ø 140 mm
H 30 mm

Rosone per collegamento da 2 a 6
Canopy for connection from 2 to 6

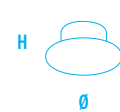

2146/R12

Ø 175 mm
H 30 mm

Rosone per collegamento da 2 a 12
Canopy for connection from 2 to 12

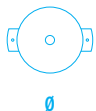

Rosone da incasso
Recessed canopy
Max 3,2 Kg

2146/R35

Ø 45 mm
H 35 mm
Ø 35 mm

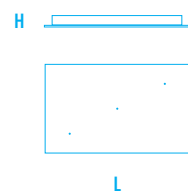

2145/PL50/3

L 530 x 300 mm
H 45 mm

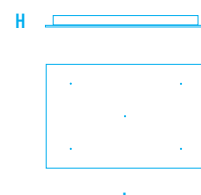

2145/PL80/5

L 800 X 500 mm
H 45 mm

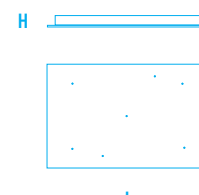

2145/PL80/7

L 800 x 500 mm
H 45 mm

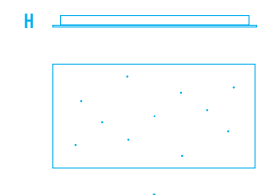

2145/PL110/11

L 1.100 x 500 mm
H 45 mm



Colori / Colors

452

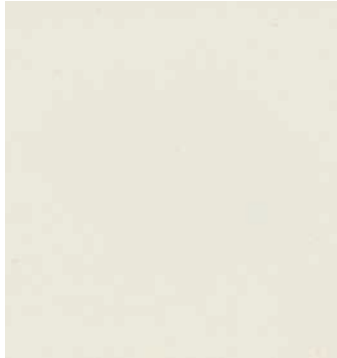

10
Bianco / White
RAL 9010



11
Cromo / Chrome



12
Nickel / Nickel

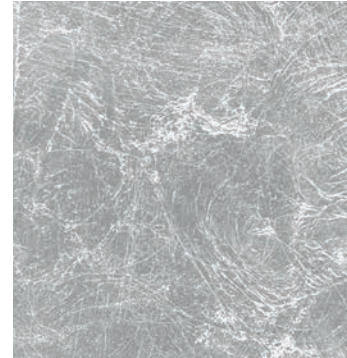

13
Foglia argento / Silver leaf finish

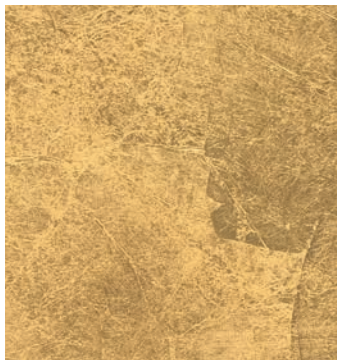

14
Foglia Oro / Gold Leaf



15
Grigio / Gray

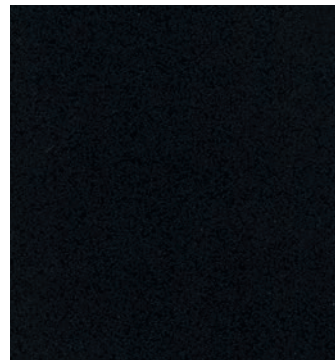

19
Nero / Black
RAL 9005



20
Corten / Corten
RAL 8019



21
Grigio tortora / Dove grey
RAL 1019



22
Foglia rame / Copper leaf finish



23
Ruggine / Rust



24
Ferro / Iron

Colori / Colors



26
Inox / *Inox*



27
Ossidato / *Oxydized*



28
Oro / *Gold*



29
Alluminio Spazzolato / *Brushed Aluminum*

453



30
Gunmetal



31
Rosé Spazzolato / *Brushed Rosé*



32
Bronzo Spazzolato / *Brushed Bronze*



33
Oro Spazzolato / *Brushed Gold*



34
Rosé Verniciato / *Painted Rosé*
(DJIBOUTI SABLÉ)

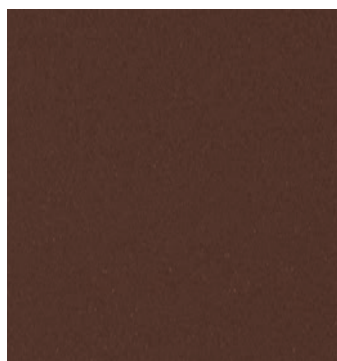

35
Bronzo Verniciato / *Bronze Painted*
(PATAH 2525)

BICOLORE · Informazioni Tecniche / TWO-TONE · Technical info

Combinazioni cromatiche per serie / *Color combinations by series:*
GEOMETRIC / NETS / HUG / LOOP / FLAT / SPIRA / ROUND



454

Esempio bicolore serie NETS / *NETS series two-color example*

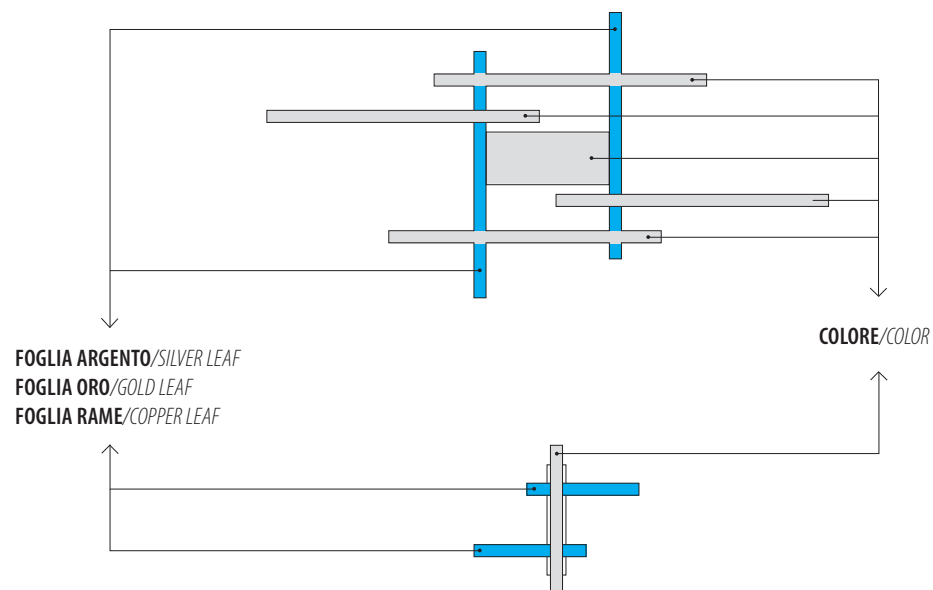

ROSONE · Informazioni Tecniche / CANOPY · Technical info

ROSONE **STANDARD BIANCO**
WHITE STANDARD CANOPY

ROSONE STANDARD **COLORATO**
STANDARD COLORED CANOPY

ROSONE MONOCOLORE **SU RICHIESTA**
ON REQUEST MONOCOLOUR CANOPY

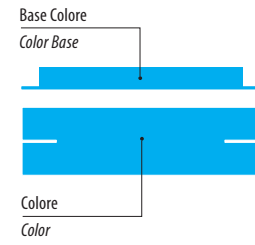
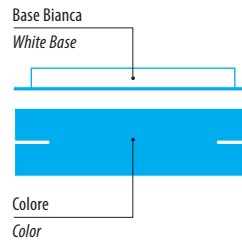
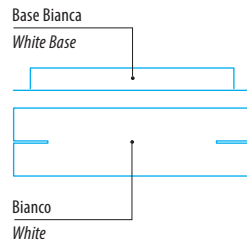
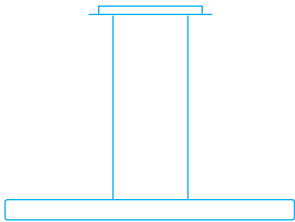

455

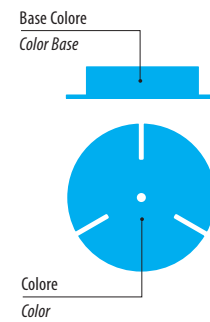
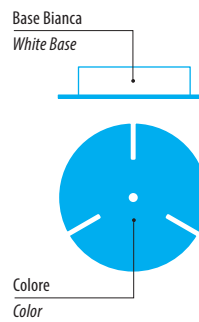
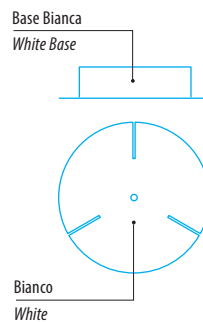
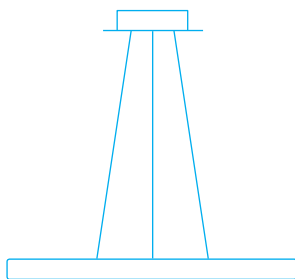
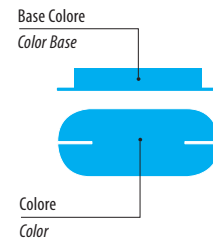
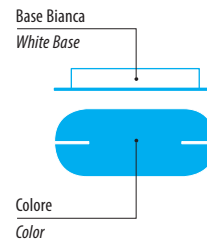
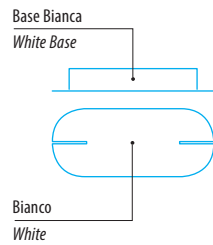
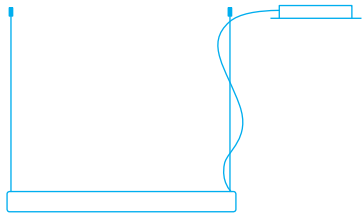



D1-D2-D3

DIMMERABLE / DIMMABLE

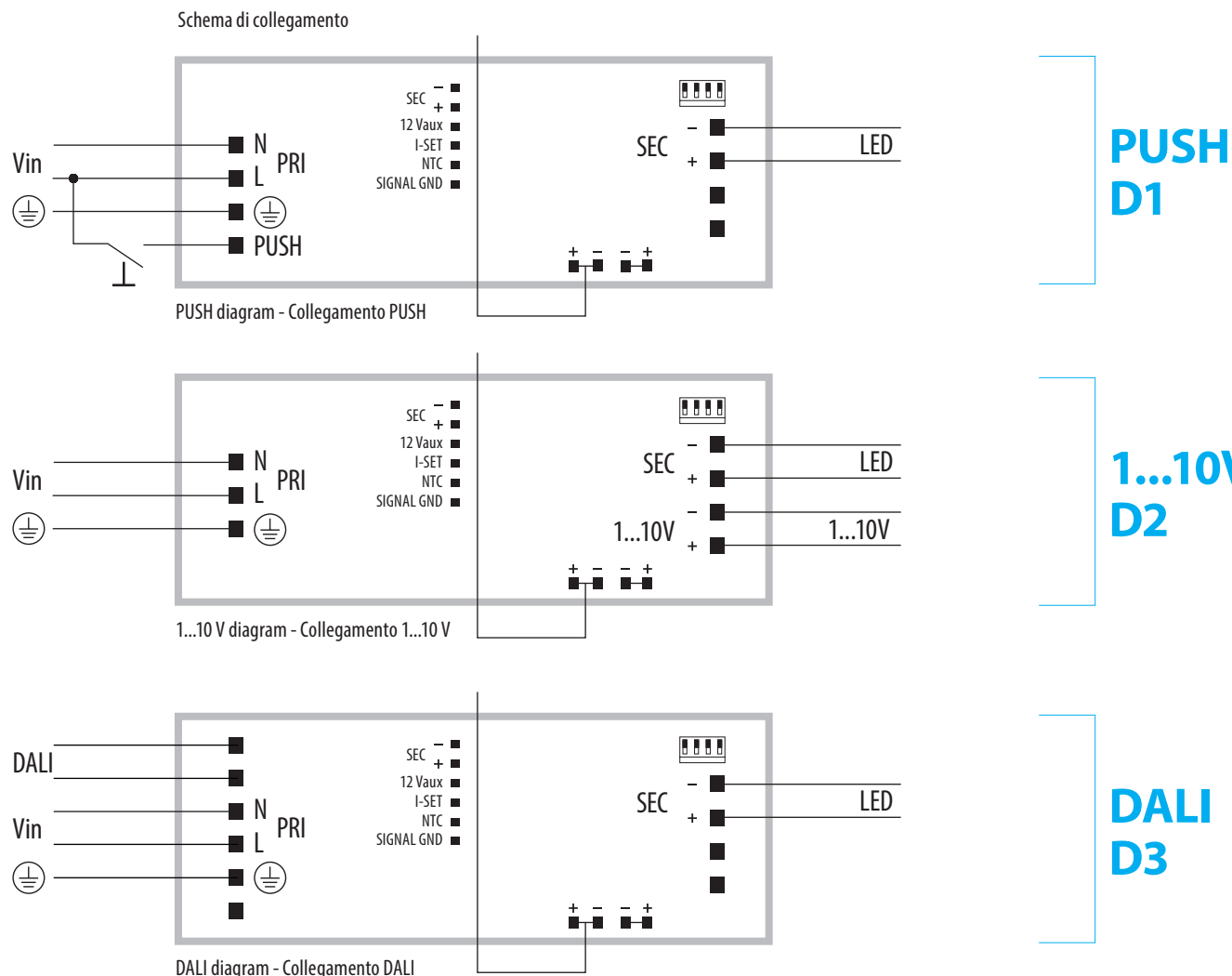

457

Modalità di funzionamento

- Regolazione della luminosità 0/0,5 - 100 % mediante funzione PUSH, interfaccia 1...10 V ($I=1$ mA) o potenziometro da 100 Kohm e DALI.
- Caratteristiche della regolazione DALI:
 - funzione di memoria per scenari o gruppi luminosi;
 - richiamo di funzioni memorizzate;
 - compatibilità con interfacce DALI standard.
- Regolazione della luminosità 0/0,5 - 100 % mediante la funzione PUSH (tensione di rete):
 - una pressione breve per accendere e spegnere;
 - una pressione prolungata per aumentare o diminuire l'intensità luminosa;
 - la regolazione si ferma automaticamente ai valori minimi e massimi;
 - per un nuovo comando accensione, regolazione o spegnimento, rilasciare il pulsante e dare nuovamente il comando desiderato.
- La lunghezza massima del cavo, dal pulsante all'ultimo trasformatore, deve essere max. 15 m / 49 ft. In caso di applicazioni dove il cavo superi i 15 m / 49 ft, tenere lo stesso separato dal cavo di rete 110 - 240 Volt.
- ATTENZIONE: usare solo pulsanti di tipo normalmente aperto privi di spia luminosa incorporata.
- Provisto di morsetto specifico per la regolazione collegando un potenziometro elettronico 1...10 Vdc (dimmerazione locale 1...10 V, per connessioni esterne all'apparecchio garantire il doppio isolamento).

Operation Mode

Light regulation 0/0,5 - 100 % by means of PUSH function, 1...10 V interface ($I=1$ mA) or 100 Kohm potentiometer and DALI.

Features DALI dimming:

- memory function for sets or light groups;
- recall of stored functions;
- compatible with standard DALI interfaces.

Light regulation 0/0,5 - 100 % by means of PUSH function (mains voltage):

- a short push to turn on and off;
- a longer push to increase or decrease light intensity;
- regulation automatically stops at minimum and maximum values;
- for another on, regulation or off command, release the push button and give the desired command again.

Maximum length of the cable, from push button to last driver, must be max. 15 m / 49 ft. In case of applications where the cable is longer than 15 m / 49 ft, keep this separate from the 110 - 240 Volt mains cable.

ATTENTION: only use normally open push buttons with no incorporated warning light.

Specific dimming terminal connection with a 1...10 Vdc electronic potentiometer (1...10 V local dimming, double insulation required for external connection).

D4

DIMMERABILE / DIMMABLE

TAGLIO DI FASE / PHASE CUT

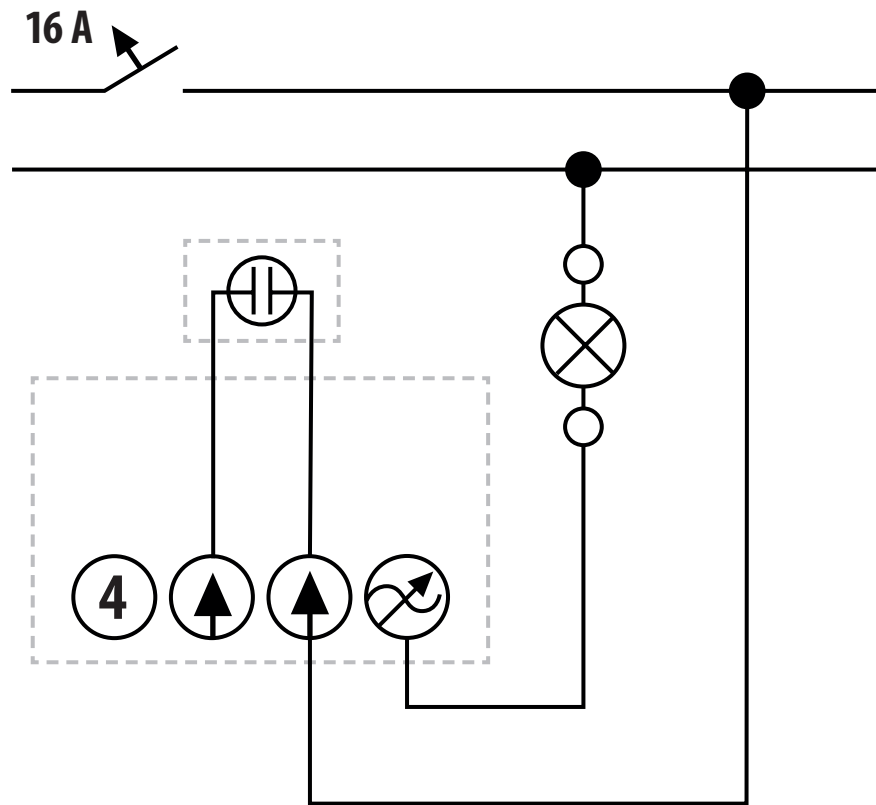

D6

DIMMERABILE / DIMMABLE

1-10V - DALI - PUSH

Modalità 0-10V/1-10V PASSIVO

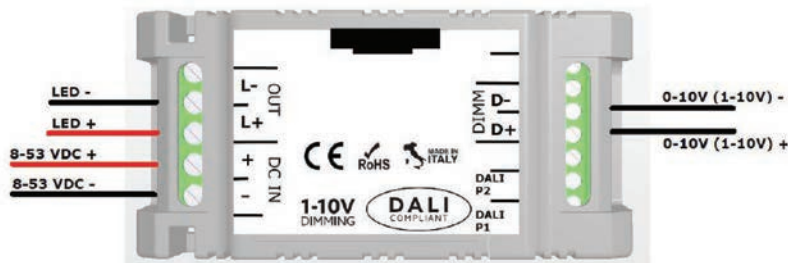

Modalità PUSH

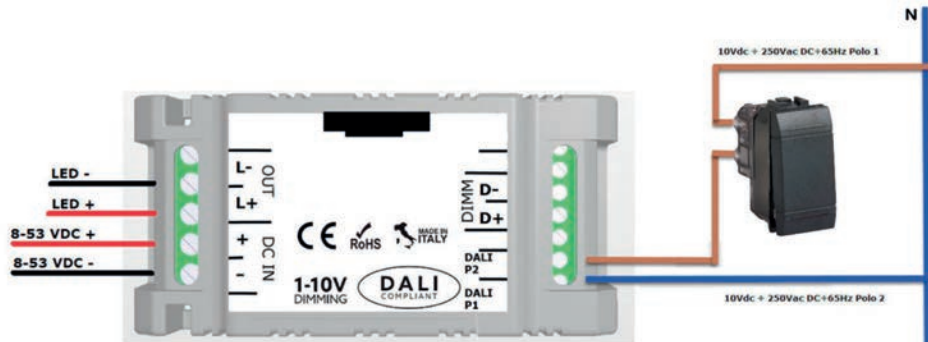

Modalità DALI

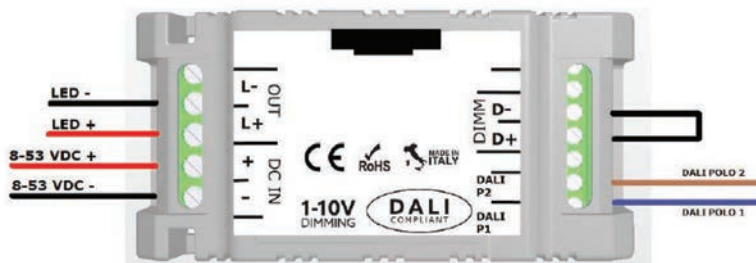

D7

DIMMERABILE / DIMMABLE

DISTANZA MASSIMA SEGNALE 8m / MAXIMUM SIGNAL DISTANCE 8m



GEOMETRIC - NETS - HUG - LOOP - SPIRA - ROUND - CLOCK - FLAT - LINK - SCIA - TAPE

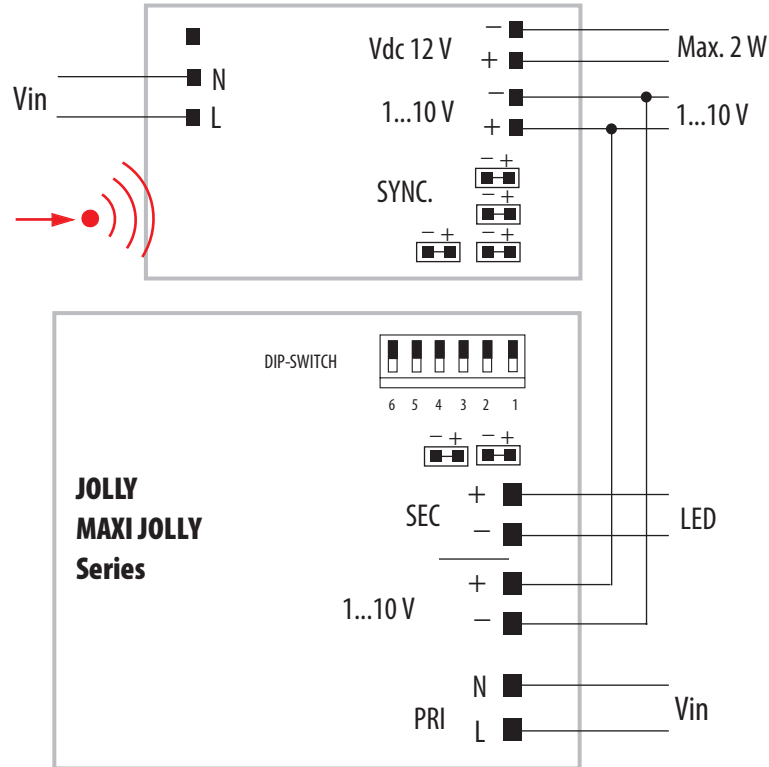

460

Funziona con / It works with:
Alexa, Google Home, Philips Hue dimmer switch

PATTERN - CRISTALLI

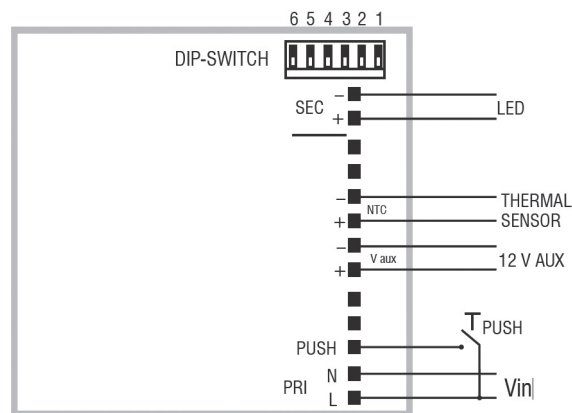

PUSH diagram - Collegamento PUSH

D8

DIMMERABILE / DIMMABLE

DOWNLOAD APP

DISTANZA MASSIMA SEGNALE 8m / MAXIMUM SIGNAL DISTANCE 8m

CASAMBI

GEOMETRIC - NETS - HUG - LOOP - SPIRA - ROUND - CLOCK - FLAT - LINK - SCIA - TAPE

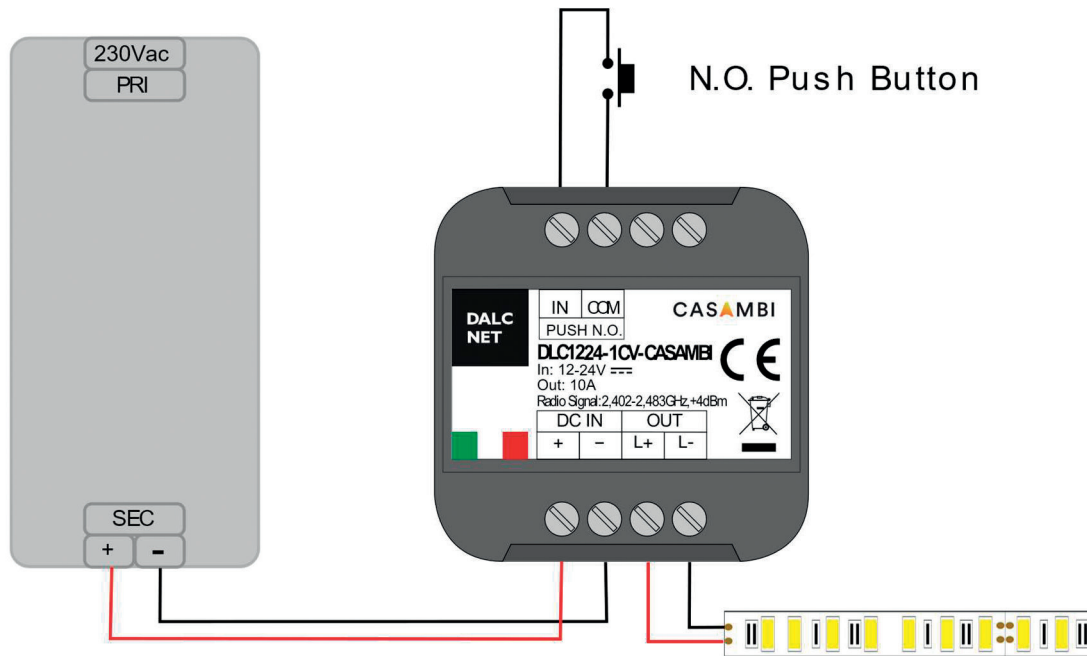

461

PATTERN - CRISTALLI

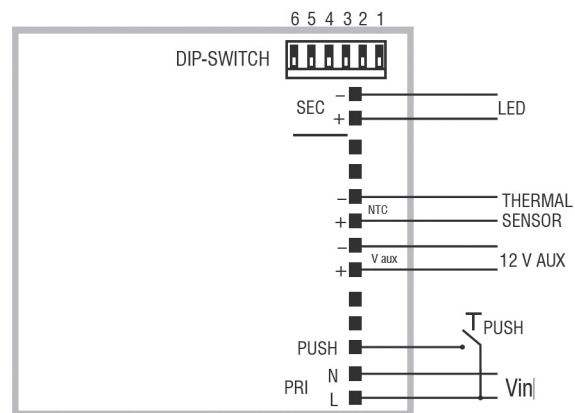

PUSH diagram - Collegamento PUSH

DIMMERABILE / DIMMABLE 230 Vac

1° OPZIONE/OPTION

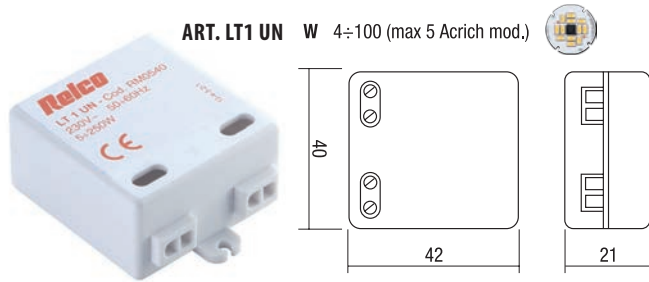

ART. LT1 UN W 4÷100 (max 5 Acrich mod.)

Schemi di collegamento - Wiring diagrams

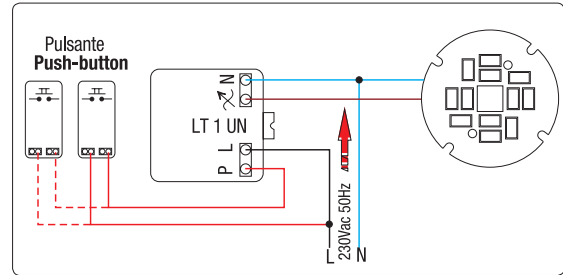

462



Regolatore da incasso universale con comando a pulsante separato

LT 1 UN è in grado di comandare:

- Lampadine a incandescenza e alogene
- Lampadine a LED dimmerabili ●
- Moduli Acrich - Acrich 2
- Lampade fluorescenti dimmerabili

L'accensione e lo spegnimento avvengono per mezzo di una breve pressione (inferiore a 0,3 sec.) su un pulsante (non utilizzare pulsanti con spia luminosa incorporata). Per ottenere la regolazione dell'intensità luminosa premere il pulsante fino al raggiungimento dell'intensità desiderata, a livello raggiunto interrompere la pressione. Qualora si desideri invertire il senso di regolazione, interrompere la pressione e ripristinarla. Allo spegnimento il livello viene memorizzato, salvo interruzioni di rete. Il comando a pulsante, offre anche la possibilità di abbinare ricevitori infrarosso e/o onde radio per ottenere un comando a distanza.

Selezione del tipo di carico

LT 1 UN è in grado di adattarsi a qualunque tipo di carico impostando tramite dip-switch (posti nella parte posteriore) il funzionamento desiderato.

La selezione deve essere effettuata in assenza di tensione di rete.

Caratteristiche Tecniche

- Assenza di ronzio acustico
- Collegamento con morsetteria
- Grado di protezione IP00
- Potenza dissipata 2W/A
- Conforme EN61058-1

Universal recessed dimmer with separate push-button control

LT 1 UN can control:

- Incandescent and halogen lamps
- Dimmable LED lamps ●
- Acrich LED modules - Acrich 2 LED modules
- Dimmable fluorescent lamps

The switching on and off takes place by means of a short touch/press (less than 0,3 seconds) of a push-button (do not use buttons with incorporated indicator light). To achieve the light intensity adjustment, press the push-button until the desired intensity level is reached; once this intensity is reached, stop pressing. If the regulation direction needs to be changed, interrupt the contact and reset the direction. The regulation level is memorised at switch-off, unless the network is interrupted.

The push-button control also offers the possibility to combine infra-red receivers and/or radio waves obtaining remote control.

Selection of the type of load

LT 1 UN is able to adapt to any type of load by setting, with the dip-switches (placed in the back), the desired function.

Technical features

- No acoustic buzzing
- Connection to a pole terminal board
- IP00 protection degree
- 2W/A dissipated power
- Compliant with EN61058-1

Adatto per installazione in scatola di derivazione o in scatola 503

Suitable for installation in junction box or in box type 503

Lampade alogene
Lampade LED dimmerabili
Halogen lamps
Dimmable LED lamps

Moduli LED
LED modules
ACRICH
ACRICH 2

Lampade fluorescenti dimmerabili
Dimmable fluorescent lamps

ON/OFF
Fluorescenti
Fluorescent

Selezione Dip-Switch - Dip-Switch selection

2° OPZIONE/OPTION



RH LED OMEGA - Cod. RN0880/LED

Varialuce per barra DIN. La regolazione avviene per mezzo di pulsanti NA (non a corredo). RH LED è realizzato con tecnologia IGBT, adatto alla regolazione di lampade alogene e lampade LED dimmerabili, è dotato inoltre di soft-start, e protezioni; termica - sovraccarico e corto circuito.

Dimmer for DIN track. Apparatuses regulated by NO push-button switches (not supplied). The RH LED has been developed with IGBT technology, suitable for halogen lamps and dimmable LED lamps. It also equipped with Soft-Start, thermal, over load and short circuit protection.

Trailing edge technology (IGBT)

| W | V | Hz | Mod | ☀ | ⚙ | PCS | CCM cm ³ |
|---|---------|----|-------|----|----|-----|---------------------|
| 10÷400 - max 40 lampadine LED/LED lamps | 220-240 | 50 | 4 DIN | NO | SI | 1 | 589,05 |
| 25÷600 - HALO lamps | 220-240 | 50 | 4 DIN | NO | SI | 1 | 589,05 |

Schema base - Wiring diagram

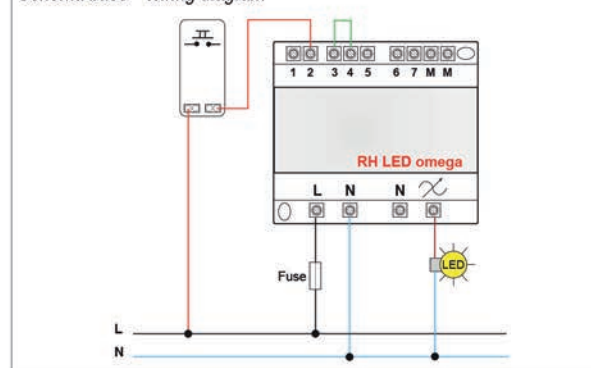

Nell'installazione bisogna prevedere sempre uno spazio d'aria libera pari a 36 mm (2 moduli DIN) tra un'apparecchiatura e l'altra.

When installing, always provide free air space of at least 36mm (2 DIN modules) between one unit and the next.

3° OPZIONE/OPTION

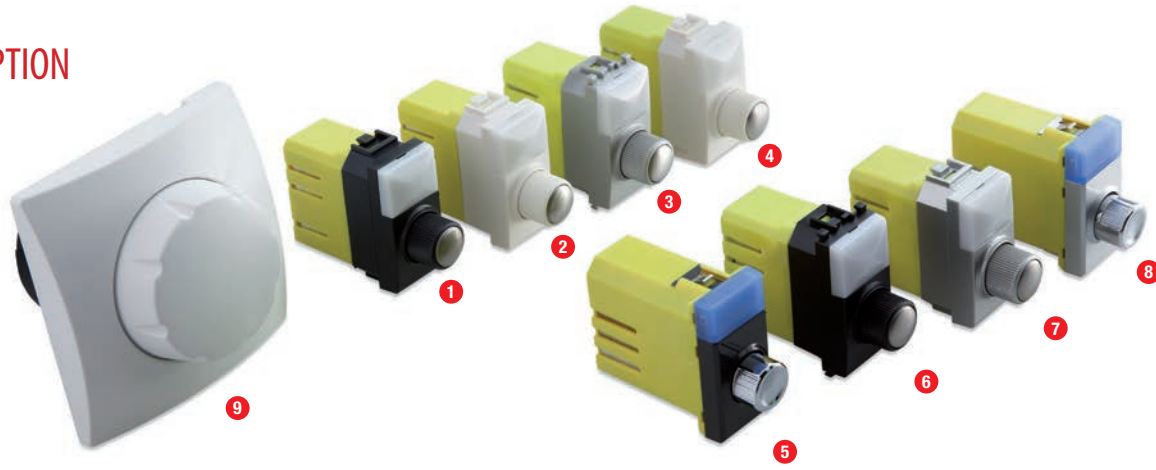

| Art. | Serie | W | Vac | Hz |
|------|-----------------|----------------|--|--------|
| 1 | DIMLED 34 DSL | International | 4÷100 (max 5 Acrich mod. - max 5 lamp) | 230 50 |
| 2 | DIMLED 34 DLT | Light | 4÷100 (max 5 Acrich mod. - max 5 lamp) | 230 50 |
| 3 | DIMLED 34 DTC | Light Tech | 4÷100 (max 5 Acrich mod. - max 5 lamp) | 230 50 |
| 4 | DIMLED 34 DVP | Vimar Plana | 4÷100 (max 5 Acrich mod. - max 5 lamp) | 230 50 |
| 5 | DIMLED 34 DAX B | Axolute | 4÷100 (max 5 Acrich mod. - max 5 lamp) | 230 50 |
| 6 | DIMLED 34 DEK A | Eikon | 4÷100 (max 5 Acrich mod. - max 5 lamp) | 230 50 |
| 7 | DIMLED 34 DAX S | Silver Axolute | 4÷100 (max 5 Acrich mod. - max 5 lamp) | 230 50 |
| 8 | DIMLED 34 DEK S | Eikon Next | 4÷100 (max 5 Acrich mod. - max 5 lamp) | 230 50 |
| 9 | DIMLED 65 DAK | Ø 65mm | 4÷100 (max 5 Acrich mod. - max 5 lamp) | 230 50 |

463



Varialuce rotativo da incasso adatto alla regolazione di:

- Lampadine a LED dimmerabili Acrich
- Moduli Acrich - Acrich 2

La potenza applicabile è pari a un minimo di 4W e un massimo di 100W.

Comando diretto mediante deviatore a pressione e regolazione mediante rotazione della manopola stessa; accensione e spegnimento mediante pressione della manopola.

DIMLED... è un dimmer di ultima generazione che sfrutta le più recenti tecnologie del microprocessore.

Built-in rotary dimmer with built in way control for:

- Dimmable LED lamps Acrich
- Acrich LED modules - Acrich 2 LED modules modular series.

The minimum power is 4W and maximum is 100W.

Direct command through deviator by pressure and regulation through rotation of the same handle grip; lighting and turning off through pressure of the handle grip.

DIMLED... a latest-generation dimmer which exploits the most recent micro-processor technology.

Schema di collegamento - Wiring diagrams

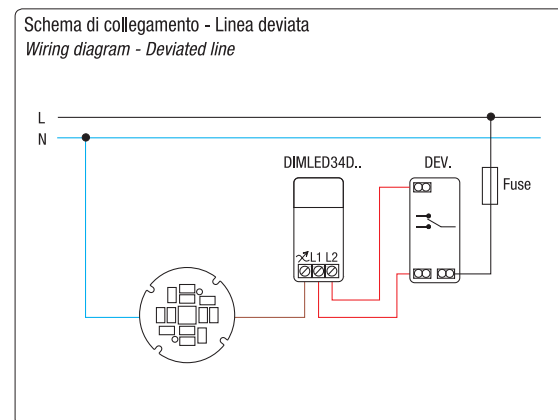
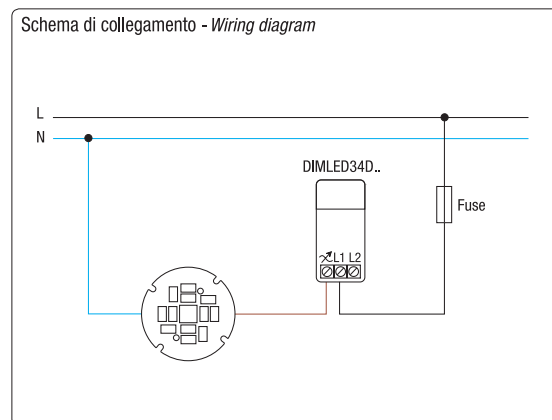

4° OPZIONE/OPTION



BUSCH JAEGER 6523U



Il marchio CE è un marchio europeo di garanzia che, rilasciato dopo una serie di rigorosi test di controllo, certifica la qualità del prodotto e la sua rispondenza ai parametri di sicurezza previsti dalle normative CE.

The CE mark is a European guarantee mark, issued after a series of strict tests, which certifies product quality and its compliance with the safety standards envisaged by EEC regulations.



Grado di protezione contro corpi solidi o liquidi.
Index protection.



Apparecchi di illuminazione nei quali le eccessive temperature che possono verificarsi in un componente a causa di un guasto, non devono surriscaldare il piano d'appoggio.
Luminaires in which the excessive temperatures which may arise due to failure of a component shall not overheat the mounting surface.



APPARECCHIO IN CLASSE II

Apparecchiature provviste di isolamento doppio o rinforzato e non aventi nessun dispositivo di collegamento a un conduttore di protezione.

CLASSE II LUMINAIRES

Luminaires supplied with double insulation and having no device for electrical bonding.



APPARECCHIO IN CLASSE I - Apparecchiature provviste di isolamento semplice: è richiesta la messa a terra di protezione.

CLASSE I LUMINAIRES - *Luminaires supplied with single insulation: protective grounding is required.*

BRAGA si riserva il diritto di apportare modifiche alle proprie collezioni, in qualunque momento e senza preavviso.

Braga reserves the right to modify our collections at any time it deems appropriate and without giving prior notice.



BRAGA
I L L U M I N A Z I O N E

BRAGA F.LLI s.n.c.
Via Soniga, 7
I-25080 Nuvolento
Brescia - Italy
P.Iva/CF IT 00737770172

UFFICIO VENDITE ITALIA

Tel. +39 - 030 691 775
Fax +39 - 030 691 296

info@fratellibraga.it

EXPORT SALES DPT.

Tel. +39 - 030 691 775
Fax +39 - 030 691 296
Cell. +39 - 388 974 8282

export@fratellibraga.it

www.fratellibraga.it

Realized by
studiopointer.com
© 07/2022

Printed in Italy by
EUROTEAM

